



MADE IN THE USA

GYNECOLOGY



WE DESIGN, MANUFACTURE, & SELL THE TOOLS THE SURGEONS USE

ELMED INC.
35 N. BRANDON DR.
GLENDALE HEIGHTS,
IL 60139
USA

WE SUBSCRIBE TO
COST CONTAINMENT
AND PROTECTION
OF THE
ENVIRONMENT



MADE IN THE USA

THEREFORE, WE
MANUFACTURE
REUSABLE PRODUCTS
FOR A CLEANER
WORLD

PH (224) 353-6446
FAX (224) 653-8178
EMAIL
MEDICAL@ELMED.COM
WWW.ELMED.COM

TABLE OF CONTENTS

VAGINAL SPECULUMS	PAGE
KRISTELLER	1
JACKSON, AUVARD, & SIMS	2
KALLMORGEN	3
LANDAU & BREISKY	4
SCHERBACK & DOYEN	5
ENDOSPECULA	PAGE
KOGAN & KOGAN-MODIF.	6
PARAMETRIUM FORCEPS	PAGE
PARAMETRIUM FORCEPS	7
HYSTERECTOMY FORCEPS	PAGE
HYSTERECTOMY FORCEPS	7
UTERINE SOUNDS	PAGE
VALLEIX, MARTIN& SIMS	8
UTERINE DILATORS	PAGE
HEGAR	9
BRAUM & HANK	10
TENACULUM FORCEPS	PAGE
STAUDE-MOORE, BARRETT, SKENE & BRAUN	11
POZZI & SCHROEDER	12
DUPLAY, IOWA, BEACHUM	13
MUSEUX, TEALE & JACOBS	14
PRATT & CZERNY	15
UTERINE POLYPUS FORCEPS	PAGE
KELLY, NOTO, DOYEN	16
DARTIGUES, SOMER & COLLIN	17
MYOMA INSTRUMENTS	PAGE
AYRE, SEGOND & DOYEN	18
FISTULA HOOKS	PAGE
SIMON & EMMET	19
CERVICAL BIOPSY FORCEPS	PAGE
SCHUBERT & FAURE	20

GELHORN, THOMS-GAYLOR	21
ALEXANDER, WITTNER, SCHUMACHER	22
VAN DOREN, SCHUMACHER	23
BERGER, EPPENDORFER, KEVORKIAN	24
UNI-TISCHLER, UNI-TOWNSEND, UNI-KEVORKIAN, UNI-OVAL, UNI-BURKE	25
TISCHLER-MORGAN USA MODEL, TINI-TISCHLER USA MODEL	26
BIOPSY CURETTES	PAGE
RANDALL, KEVORKIAN, NOVAK, MINI-NOVAK	27
SCHULTZ	28
ASPIRATING CURETTES	PAGE
ASPIRATING CURETTES	29
UTERINE CURETTES	PAGE
MINI-NOVAK	30
RECAMIER	31
SIMS	32
UTERINE SPOONS	PAGE
SIMON, SHRODER	33
OBSTETRICAL FORCEPS	PAGE
SIMPSON, SIMPSON-BRAUN	34
SIMPSON-LUIKART, WRIGLEY, DELEE	35
ELLIOT, MCLEAN, KIELLAND, LIELLAND-LUKART, BILL	36
OBSTETRICS	PAGE
SELLHEIM, BRAUN, GREEN-ARMYTAGE	37
SMELLIE, BRAUN, TARNIER	38
PELVIMETERS	PAGE
MARTIN, COLLIN	39
UMBILICAL CORD CLAMP	PAGE
KANE, COLLIN	39
NON-CONDUCTIVE INSTRUMENTS	PAGE
FORCEPS	
ADSON DRESSING FORCEPS, ADSON FORCEPS 1X2 TEETH, DRESSING FORCEPS	40
POTTS-SMITH DRESSING FORCEPS, POTTS-SMITH DRESSING FORCEPS 1X2	41
DEBAKEY TISSUE FORCEPS, TUTTLE/SINGLEY FORCEPS	42

RING FOERSTER/SCHWEIZER FORCEPS, RING CLEMETSON FORCEPS, RING LAUFE UTERINE POLYP FORCEPS, BOZEMAN FORCEPS, BOZEMAN FORCEPS LARGE RING HANDLE	43
SCHROEDER TENACULUM FORCEPS-SINGLE TOOTH POINTED, SCHROEDER TENACULUM FORCEPS-DOUBLE TEETH POINTED, BABCOCK, ALLIS TISSUE FORCEPS	44
RETRACTORS	PAGE
CUSHING VEIN, DOYEN, FARABEUF(2)	45
RIGBY, GELPI PERINEAL, EASTMAN, TAUBER SPATULA, SEGOND SPATULA	46
FOMON DOUBLE BALL, SENN-MUELLER, RAGNELL-DAVIS, DEMARRES LID RETRACTOR	47
BRIESKY-NAVATIL VAGINAL RETRACTOR	48
SIMS (SINGLE & DOUBLE END), JACKSON	49
HEANY, HEANEY-SIMON, RIBBON MALLEABLE, US ARMY-NAVY (SET OF 2)	50
DEAVER, RICHARDSON, RICHARDSON EASTMAN	51
LATERAL WALL RETRACTOR—GOLD PLATED RATCHET HANDLE (OPEN SHANKS), GOLD PLATED SPRING HANDLE (CLOSED SHANKS)	52
TRU-VIEW™ LATERAL WALL RETRACTOR—GOLD PLATED RATCHET HANDLE—TAPERED BLADES	53
SPECULUMS	PAGE
GRAVES SPECULUM-CLOSED SIDE	54
PEDERSON SPECULUM-CLOSED SIDE	55
WEISMAN GRAVES SPECULUM—90° HANDLE	56
WEISMAN GRAVES SPECULUM—45° HANDLE	57
WEISMAN-PEDERSON SPECULUM—90° HANDLE	58
WEISMAN-PEDERSON SPECULUM—45° HANDLE	59
GRAVES VU-MORE™ SPECULUM-1 ⁵ / ₈ " WIDE YOKE	60
PEDERSON VU-MORE SPECULUM—1 ⁵ / ₈ " WIDE YOKE	61
GRAVES WIDE VIEW VU-MAX SPECULUM—2 ³ / ₄ " SQUARE YOKE	62
PEDERSON WIDE VIEW VU-MAX SPECULUM—2 ³ / ₄ " SQUARE YOKE	63
MAX VIEW 4 BLADED SPECULUM, COLLIN SPECULUM	64
CUSCO, KOGAN ENDOCERVICAL	65
AUVARD SPECULUM	66
STEINER-AUVARD SPECULUM	67
COMPACT WEIGHTED "E" SPECULUM	68
COMPACT HEANY STYLE	69

STAINLESS STEEL DILATOR	70
IRIS QUICK RELEASE, EMMETT	71
JOSEPH SKIN HOOKS— POINTED TIP, 3 PRONG, GUTHRIE—DOUBLE HOOK SHARP	72
NON-CONDUCTIVE LEEP RULER	PAGE
NON-CONDUCTIVE LEEP RULER	73
LASER BLACK INSTRUMENTS	
FORCEPS	PAGE
ADSON DRESSING, TISSUE-1X2 TEETH, DRESSING	74
POTTS-SMITH DRESSING, POTTS-SMITH DRESSING (1X2 TEETH)	75
DEBAKEY TISSUE, TUTTLE/SINGLEY	76
RING FOERSTER/SCHWEIZER, RING CLEMETSON, RING LAUFE UTERINE POLYP, BOZEMAN, BOZEMAN LARGE RING HANDLE	77
SCHROEDER TENACULUM-SINGLE TOOTH POINTED (POZZI STYLE-ROUND TIP & BRAUN STYLE-FLAT TIP)	78
SCHROEDER TENACULUM-DOUBLE TEETH, POINTED	78
BABCOCK, ALLIS TISSUE-5X6 TEETH	78
RETRACTORS	PAGE
CUSHING VEIN, FARBEUF-SET OF 2, DOYEN, DEMARRES LID RETRACTORS	79
RIGBY, GELPI, EASTMAN	80
TAUBER VAGINAL SPATULA, SEGOND VAGINAL SPATULA	80
FOMON-DOUBLE BALL TIP, SENN-MUELLER, RAGNELL-DAVIS	81
BRIESKY-NAVRATIL	82
SIMS-SINGLE END, SIMS-DOUBLE END, JACKSON-SINGLE END	83
HEANEY, HEANEY-SIMON, RIBBON MALLEABLE, US ARMY-NAVY (SET OF 2)	84
DEAVER, RICHARDSON, RICHARDSON EASTMAN	85
LATERAL WALL RETRACTOR—RATCHET HANDLE-OPEN SHANKS	86
LATERAL WALL RETRACTOR—SPRING RATCHET HANDLE-CLOSED SHANKS	86
TRU-VIEW™ LATERAL WALL RETRACTOR-RATCHET HANDLE, TAPERED BLADES	87
SPECULUMS	PAGE
LASER BLACK GRAVES VAGINAL SPECULUM	88
PEDERSON-CLOSED SIDE	89
WEISMAN GRAVES—90° HANDLE	90
WEISMAN PEDERSON—90° HANDLE	91
WESIMAN GRAVES—45° HANDLE	92
WESIMAN PEDERSON— 45° HANDLE	93

GRAVES VU-MORE™ - 1 ⁵ / ₈ " WIDE YOKE	94
PEDERSON VU-MORE™ -1 ⁵ / ₈ " WIDE YOKE	95
GRAVES VU-MORE™ -2 ³ / ₄ " WIDE YOKE	96
PEDERSON VU-MORE™ -2 ³ / ₄ " WIDE YOKE	97
MAX VIEW 4 BLADED, COLLIN	98
CUSCO, KOGAN ENDOCERVICAL	99
AUVARD	100
STEINER-AUVARD	101
COMPACT WEIGHTED "E"	102
COMPACT HEANEY	103
STAINLESS STEEL DILATOR	104
HOOKS	PAGE
JOSEPH SKIN-POINTED TIPS, GUTHRIE DOUBLE—SHARP, 3 PRONG	105
IRIS, EMMETT	106
LASER BLACK LEEP RULER	PAGE
LASER BLACK LEEP RULER	107
SERVICE AND REPAIR	PAGE
SERVICE AND REPAIR	108



VAGINAL SPECULUMS



MADE IN THE USA



KRISTELLER

70 MM X 27 MM	32050-01
80 MM X 30 MM	32050-02
90 MM X 36 MM	32050-03
110 MM X 27 MM	32050-04
110 MM X 30 MM	32050-05
110 MM X 36 MM	32050-06

SPECULUM



75 MM X 23 MM	32051-01
85 MM X 26 MM	32051-02
100 MM X 32 MM	32051-03
115 MM X 23 MM	32051-04
115 MM X 26 MM	32051-05
115 MM X 32 MM	32051-06

RETRACTOR



32052-01
32052-02
32052-03
32052-04
32052-05
32052-06
<i>SET</i>



KRISTELLER

105 MM X 18 MM	32055-01
105 MM X 21 MM	32055-02

SPECULUM TAPERED, FOR VIRGINS



110 MM X 14 MM	32056-01
115 MM X 17 MM	32056-02

RETRACTOR



32057-01
32057-02
<i>SET</i>



WE DESIGN, MANUFACTURE & SELL THE TOOLS THE SURGEONS USE



VAGINAL SPECULUMS



MADE IN THE USA

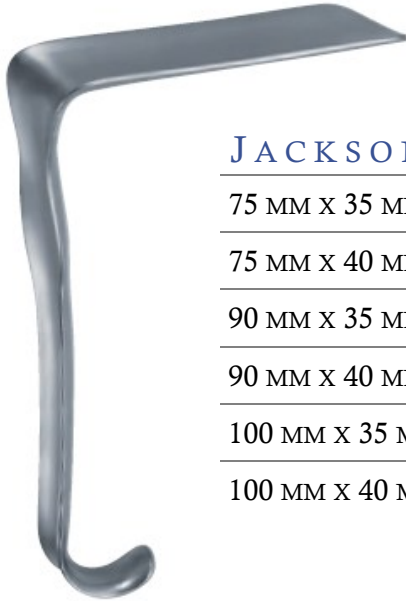

JACKSON

75 MM X 35 MM	32070-10
75 MM X 40 MM	32070-15
90 MM X 35 MM	32070-20
90 MM X 40 MM	32070-25
100 MM X 35 MM	32070-30
100 MM X 40 MM	32070-35



AUWARD

220 MM – 8 3/4 "
80 MM X 38 MM
32060-00

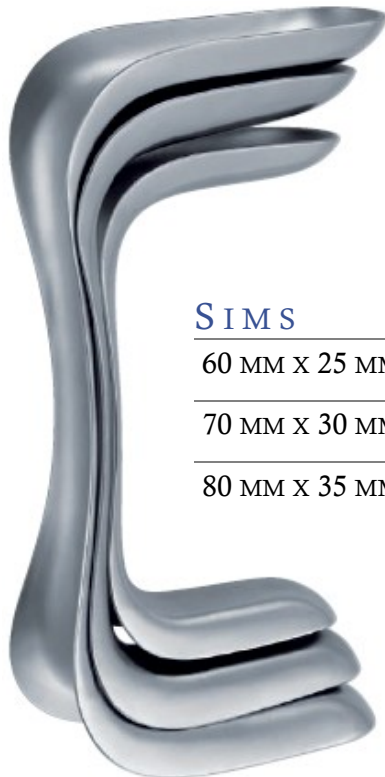

SIMS

60 MM X 25 MM / 30 MM	32075-01
70 MM X 30 MM / 35 MM	32075-02
80 MM X 35 MM / 40 MM	32075-03



TO ORDER CALL: (224) 353-6446



VAGINAL SPECULUMS



MADE IN THE USA



KALLMORGEN

70 MM X 40 MM	32072-01
90 MM X 40 MM	32072-02

SPECULUM



70 MM X 33 MM	32073-01
90 MM X 33 MM	32073-02

RETRACTOR



32074-01

32074-02

SET





VAGINAL SPECULUMS



MADE IN THE USA



LANDAU

	290 MM – 11½"
100 MM X 28 MM	32128-01
110 MM X 38 MM	32128-02

	300 MM – 12"
100 MM X 20 MM	32142-20
100 MM X 25 MM	32142-25
100 MM X 30 MM	32142-30
100 MM X 35 MM	32142-35
100 MM X 40 MM	32142-40

BREISKY

	300 MM – 12"
130 MM X 20 MM	32130-20
130 MM X 25 MM	32130-25
130 MM X 30 MM	32130-30
130 MM X 35 MM	32130-35
130 MM X 40 MM	32130-40

	350 MM – 13¾"
160 MM X 40 MM	32140-40
180 MM X 40 MM	32140-41

VIENNA PATTERN



TO ORDER CALL: (224) 353-6446



VAGINAL SPECULUMS



MADE IN THE USA



FIG. 1

80 MM X 30 MM

32090-01



FIG. 2

85 MM X 35 MM

32090-02



FIG. 3

90 MM X 40 MM

32090-03



FIG. 4

55 MM X 40 MM /
60 MM

32090-04



FIG. 5

70 MM X 45 MM /
70 MM

32090-05

SCHERBACK

32090-00

SET WITH WEIGHT 400 GRs. (32090-10)



400 G

800 G

32090-10

32090-12

32090-14



DOYEN



	240 MM – 9 ½"	240 MM – 9 ½"
55 MM X 35 MM	32100-01	32110-01
75 MM X 35 MM	32100-02	32110-02
115 MM X 35 MM	32100-03	32110-03
55 MM X 45 MM	32102-01	32112-01
75 MM X 45 MM	32102-02	32112-02
115 MM X 45 MM	32102-03	32112-03
160 MM X 45 MM	32102-04	32112-04
55 MM X 60 MM	32104-01	32114-01
75 MM X 60 MM	32104-02	32114-02
115 MM X 60 MM	32104-03	32114-03
165 MM X 60 MM	32104-04	

SLIGHTLY CONCAVE

MEDIUM CONCAVE





ENDOSPECULA



MADE IN THE USA



KOGAN

240 MM – 9 ½"

32153-24

*WITH SCALE-RATCHET AND
FIXATION SCREW*



KOGAN

240 MM – 9 ½"

32154-24



KOGAN-MODIF.

280 MM – 11 "

X = 4 MM Y = 8 MM

32150-01

X = 2 MM Y = 4 MM

32150-02



TO ORDER CALL: (224) 353-6446



PARAMETRIUM FORCEPS



MADE IN THE USA

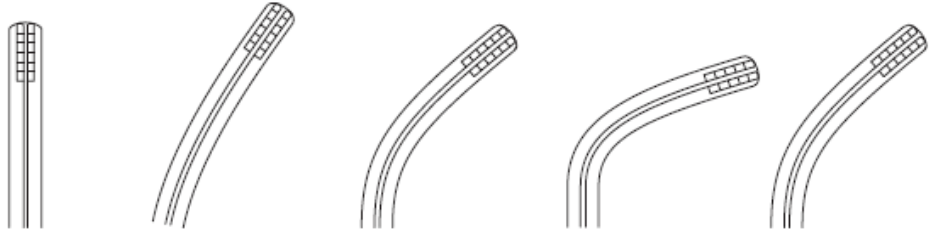
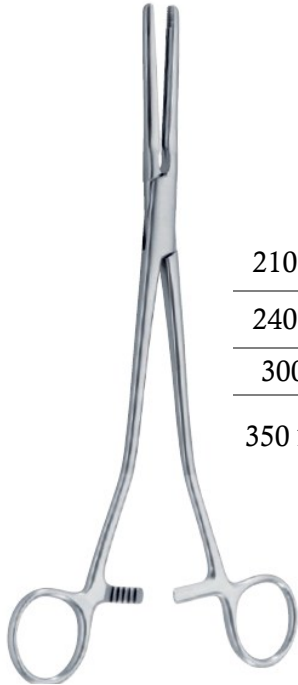

210 MM – 8 ¼"	32155-21	32156-21	32157-21	32158-21	32159-21
240 MM – 9 ½"	32155-24	32156-24	32157-24	32158-24	32159-24
300 MM – 12"	32155-30	32156-30	32157-30	32158-30	32159-30
350 MM – 13 ¾"	32155-35	32156-35	32157-35	32158-35	32159-35
					<i>S-CURVED</i>

HYSTERECTOMY FORCEPS

ROGERS

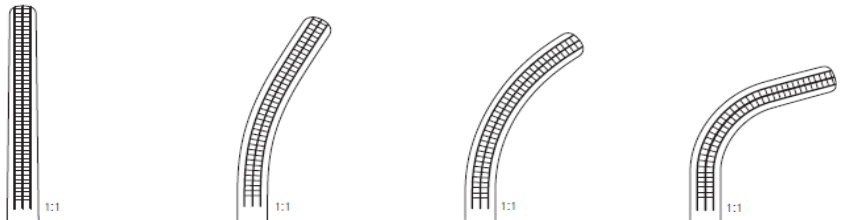

FIG. 1	FIG. 2	FIG. 3	FIG. 4
220 MM – 8 ¾"	215 MM – 8 ½"	210 MM – 8 ¼"	205 MM – 8"
32147-01	32147-02	32147-03	32147-04

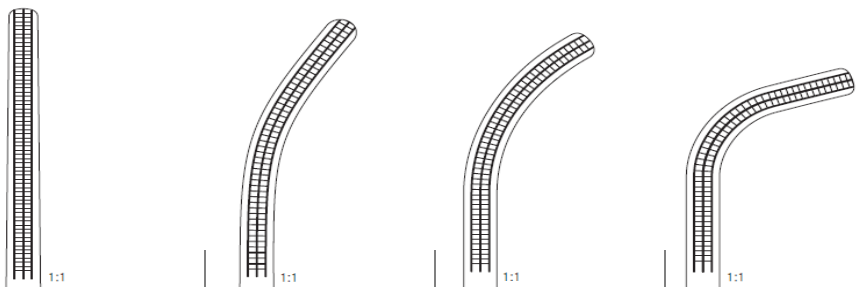

FIG. 1	FIG. 2	FIG. 3	FIG. 4
250 MM – 9 ¾"	250 MM – 9 ¾"	245 MM – 9 ¾"	230 MM – 9"
32148-01	32148-02	32148-03	32148-04





UTERINE SOUNDS



MADE IN THE USA



VALLEIX

250 MM – 9 3/4" **32197-25**

GRADUATED, WITH SLIDER



MARTIN

320 MM – 12 1/2" **32198-32** **32199-32**

RIGID

MALLEABLE



SIMS

320 MM – 12 1/2" **32200-32** **32201-32**

RIGID

MALLEABLE



TO ORDER CALL: (224) 353-6446



UTERINE DILATORS



MADE IN THE USA

HEGAR



1.0 MM Ø	32250-10
1.5 MM Ø	32250-15
2.0 MM Ø	32250-20
2.5 MM Ø	32250-25
3.0 MM Ø	32250-30
3.5 MM Ø	32250-35
4.0 MM Ø	32250-40
4.5 MM Ø	32250-45
5.0 MM Ø	32250-50
5.5 MM Ø	32250-55
6.0 MM Ø	32250-60
6.5 MM Ø	32250-65
7.0 MM Ø	32250-70
7.5 MM Ø	32250-75
8.0 MM Ø	32250-80
8.5 MM Ø	32250-85
9.0 MM Ø	32250-90
9.5 MM Ø	32250-95

10.0 MM Ø	32251-00
10.5 MM Ø	32251-05
11.0 MM Ø	32251-10
11.5 MM Ø	32251-15
12.0 MM Ø	32251-20
12.5 MM Ø	32251-25
13.0 MM Ø	32251-30
13.5 MM Ø	32251-35
14.0 MM Ø	32251-40
14.5 MM Ø	32251-45
15.0 MM Ø	32251-50
15.5 MM Ø	32251-55
16.0 MM Ø	32251-60
16.5 MM Ø	32251-65
17.0 MM Ø	32251-70
17.5 MM Ø	32251-75
18.0 MM Ø	32251-80
18.5 MM Ø	32251-85
19.0 MM Ø	32251-90
19.5 MM Ø	32251-95

20.0 MM Ø	32252-00
21.0 MM Ø	32252-10
22.0 MM Ø	32252-20
23.0 MM Ø	32252-30
24.0 MM Ø	32252-40
25.0 MM Ø	32252-50
26.0 MM Ø	32252-60
27.0 MM Ø	32252-70
28.0 MM Ø	32252-80
29.0 MM Ø	32252-90
30.0 MM Ø	32253-00

HEGAR

4 MM - 17 MM Ø	14	32260-14
1 MM - 26 MM Ø	26	32260-26
	<i>PIECES PER SET</i>	<i>SET, WITHOUT METAL CASE</i>

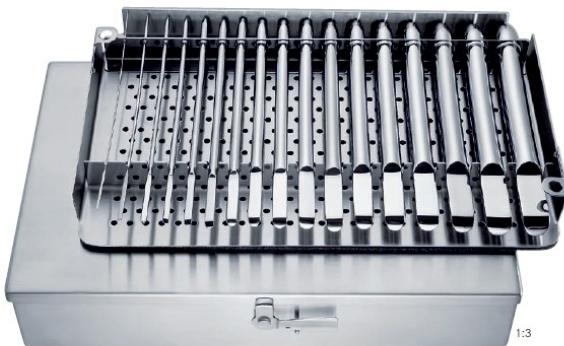

HEGAR

4 MM - 17 MM Ø	14	32261-14
1 MM - 26 MM Ø	26	32261-26
	<i>PIECES PER SET</i>	<i>SET, IN METAL CASE</i>





UTERINE DILATORS



MADE IN THE USA

HEGAR



1 / 2 MM Ø	32262-02
3 / 4 MM Ø	32262-04
5 / 6 MM Ø	32262-06
7 / 8 MM Ø	32262-08
9 / 10 MM Ø	32262-10
11 / 12 MM Ø	32262-12
13 / 14 MM Ø	32262-14
15 / 16 MM Ø	32262-16
17 / 18 MM Ø	32262-18
19 / 20 MM Ø	32262-20
21 / 22 MM Ø	32262-22
23 / 24 MM Ø	32262-24
25 / 26 MM Ø	32262-26

HEGAR

3 / 4 MM — 17 / 18 MM Ø	14	32265-05
1 / 2 MM — 25 / 26 MM Ø	26	32265-06
	<i>PIECES PER SET</i>	<i>SET, ONLY</i>



BRAUM

280 MM — 11"

32295-26

HANK



FIG. 19/10	4.5 / 5.0 MM Ø	32280-10
FIG. 11/12	5.5 / 6.0 MM Ø	32280-12
FIG. 13/14	6.5 / 7.0 MM Ø	32280-14
FIG. 15/16	7.5 / 8.0 MM Ø	32280-16
FIG. 17/18	8.5 / 9.0 MM Ø	32280-18
FIG. 19/20	9.5 / 10.0 MM Ø	32280-20

HANK

4.5 / 5 MM — 9.5 / 10 MM Ø	6	32281-80
	<i>PIECES PER SET</i>	<i>SET, ONLY</i>



TO ORDER CALL: (224) 353-6446



TENACULUM FORCEPS



MADE IN THE USA



STAUDE-MOORE

170 MM — 6 ¾"

32302-17



BARRETT

180 MM — 7"

32305-18



SKENE

240 MM — 9 ½"

32301-24



BRAUN

250 MM — 9 ¾"

32303-25





TENACULUM FORCEPS



MADE IN THE USA



POZZI

255 MM — 10"

32311-26



SCHROEDER

250 MM — 9 3/4"

32610-25



SCHROEDER

240 MM — 9 1/2"



32314-24



32315-24



TO ORDER CALL: (224) 353-6446



TENACULUM FORCEPS



MADE IN THE USA



DUPLAY

280 MM — 11"

32320-28



IOWA

260 MM — 10 ¼"

32329-26



BEACHAM

260 MM — 10 ¼"

32322-26

AMNIOTOME





TENACULUM FORCEPS



MADE IN THE USA



MUSEUX

	240 MM — 9 ½"	240 MM — 9 ½"
6 MM	32353-24	32358-24
8 MM	32352-24	32357-24
10 MM	32351-24	32356-24



TEALE

230 MM — 9"
32328-23



JACOBS

210 MM — 8 ¼" | **32360-21** | **32361-21**



TO ORDER CALL: (224) 353-6446



TENACULUM FORCEPS



MADE IN THE USA



PRATT

260 MM — 10 ¼"

32364-26



CZERNY

205 MM — 8"

32366-21





UTERINE POLYPUS FORCEPS



MADE IN THE USA

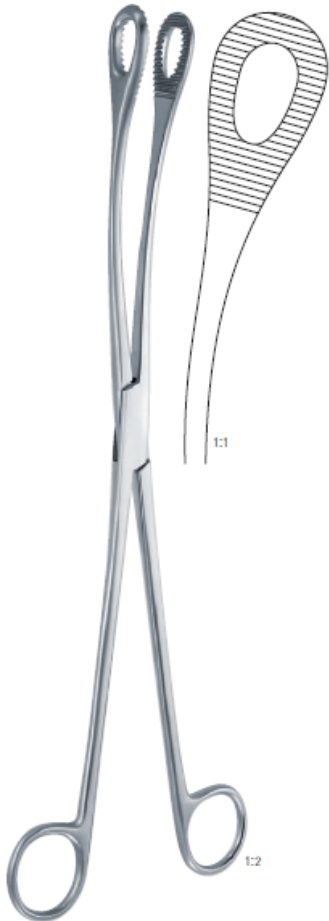

KELLY

320 MM — 12 1/2" | **32380-32**



NOTO

270 MM — 10 3/4" | **32375-27**

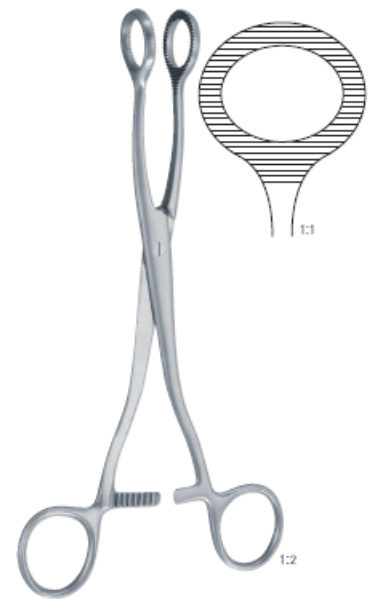

DOYEN

200 MM — 8" | **32370-20**



TO ORDER CALL: (224) 353-6446



UTERINE SEIZING FORCEPS



MADE IN THE USA



DARTIGUES

270 MM — 10 3/4"

32394-27



SOMER

230 MM — 9"

32393-23



COLLIN

250 MM — 9 3/4"

32395-25





MYOMA INSTRUMENTS



MADE IN THE USA



AYRE

230 MM — 9"

32396-23



SEGOND

270 MM — 10 3/4"

32397-27



DOYEN

170 MM — 6 3/4"

32399-02



TO ORDER CALL: (224) 353-6446



FISTULA HOOKS



MADE IN THE USA



SIMON

	FIG. 1	FIG. 2
220 MM — 8 3/4"	32398-01	32398-02



EMMET

	FIG. 1	FIG. 2
220 MM — 8 3/4"	32958-01	32958-02

	FIG. 3	FIG. 4
220 MM — 8 3/4"	32958-03	32958-04

	FIG. 5
220 MM — 8 3/4"	32958-05





CERVICAL BIOPSY FORCEPS



MADE IN THE USA



SCHUBERT

210 MM — 8 ½"	32400-21
280 MM — 11"	32400-29



FAURE

210 MM — 8 ½"	32410-24
---------------	-----------------



SCHUBERT

260 mm — 10 ¼"	32440-26
----------------	-----------------



TO ORDER CALL: (224) 353-6446



CERVICAL BIOPSY FORCEPS



MADE IN THE USA



GELLHORN

230 MM — 9"	32402-23
-------------	-----------------



THOMS-GAYLOR

220 MM — 8 ¾"	32420-22
240 MM — 9 ½"	32420-24





CERVICAL BIOPSY FORCEPS



MADE IN THE USA

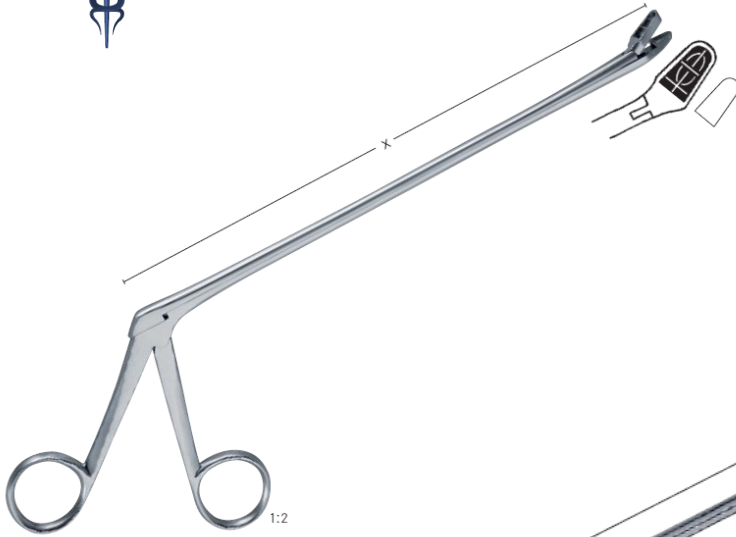

ALEXANDER

280 MM — 11"

32450-28

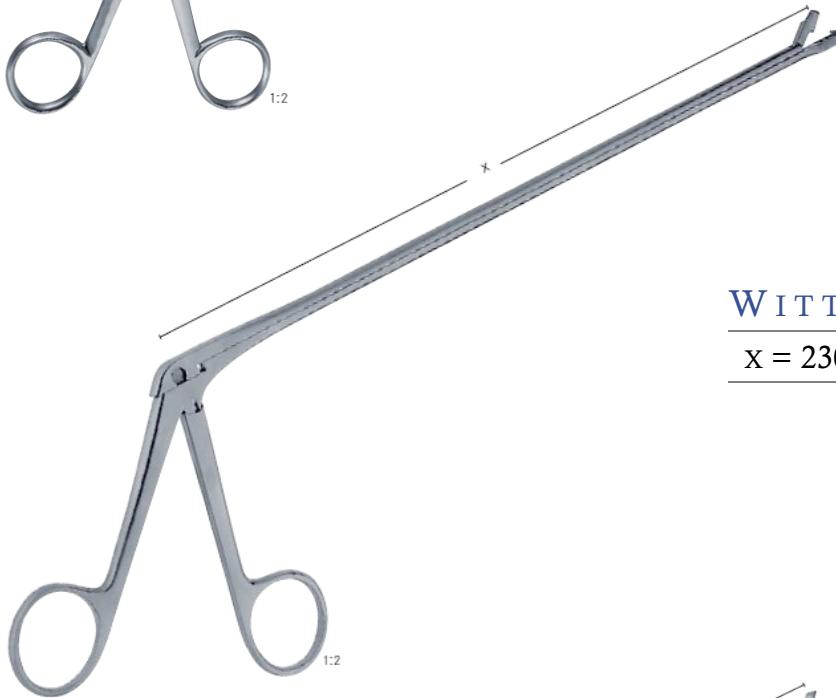

WITTNER

X = 230 MM — 9"



32460-23

32461-23

STRAIGHT

CURVED



SCHUMACHER

X = 230 MM — 9"

32470-00

32470-01

COMPLETE

TIP



TO ORDER CALL: (224) 353-6446



CERVICAL BIOPSY FORCEPS





MADE IN THE USA





VAN DOREN
 240 MM — 9 1/2"
 32470-25

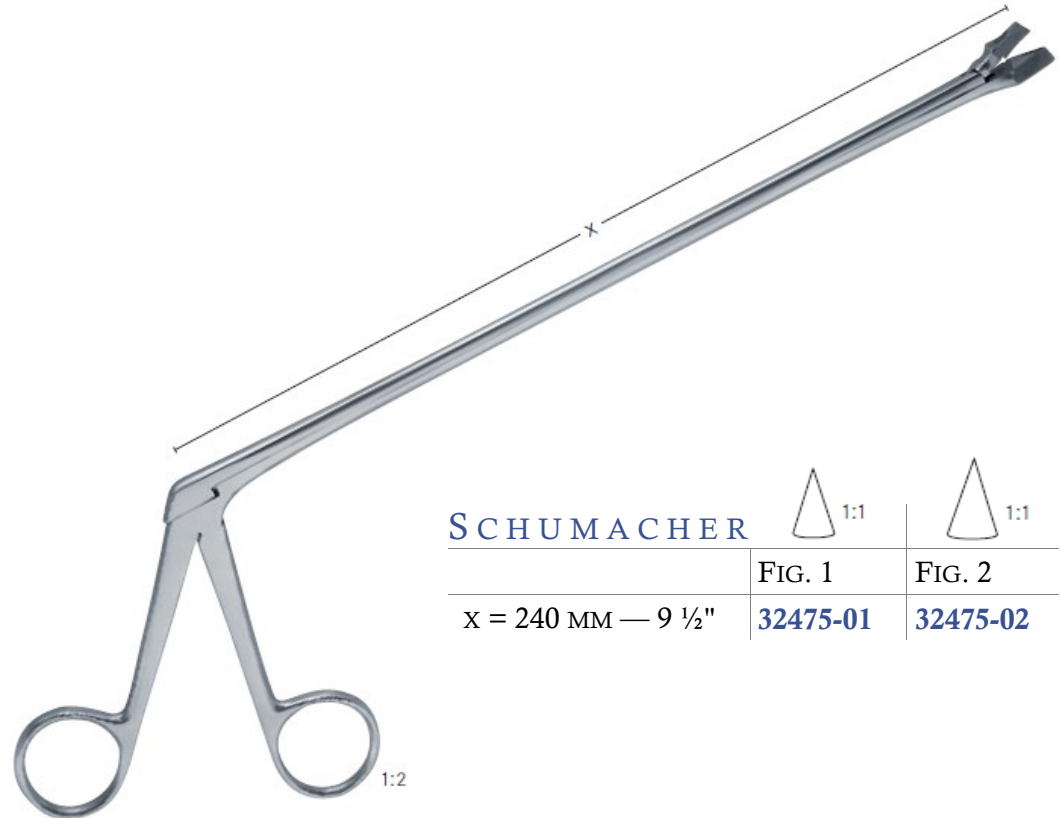

SCHUMACHER	 1:1	 1:1
	FIG. 1	FIG. 2
240 MM — 9 1/2"	32473-01	32473-02



SCHUMACHER	 1:1	 1:1
	FIG. 1	FIG. 2
x = 240 MM — 9 1/2"	32475-01	32475-02





CERVICAL BIOPSY FORCEPS



MADE IN THE USA

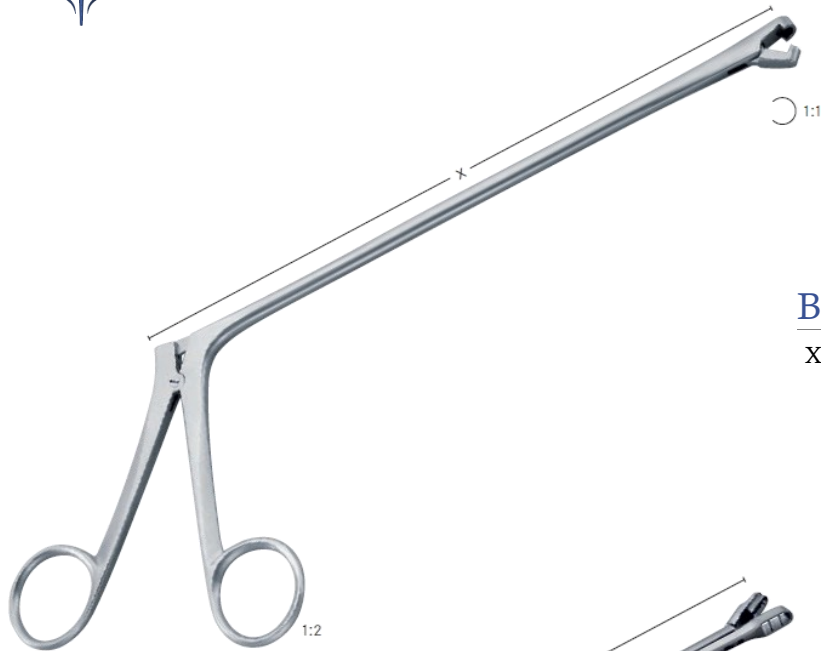

BERGER

X = 200 MM — 8"

32480-25



EPPENDORFER

X = 200 MM — 8"

32487-20



KEVORKIAN

X = 245 MM — 9 3/4"

32489-24



TO ORDER CALL: (224) 353-6446



CERVICAL BIOPSY FORCEPS



MADE IN THE USA



UNI-TISCHLER

3 x 7 MM **32492-01**

STRAIGHT, TIP ONLY



32490-00

HANDLE ONLY



UNI-TISCHLER

3 x 7 MM **32492-02**

UP, TIP ONLY



UNI-TISCHLER

3 x 7 MM **32492-03**

DOWN, TIP ONLY



UNI-TOWNSEND

2.3 x 4 MM **32492-04**

STRAIGHT, TIP ONLY



UNI-TOWNSEND

2.3 x 4 MM **32492-05**

UP, TIP ONLY



UNI-TOWNSEND

2.3 x 4 MM **32492-06**

DOWN, TIP ONLY



UNI-KEVORKIAN

3 x 9 MM **32492-07**

TIP ONLY



32491-00

HANDLE



UNI-OVAL

3 x 5 MM **32492-08**

TIP ONLY



UNI-BURKE

3 x 5 MM **32492-09**

TIP ONLY





CERVICAL BIOPSY FORCEPS



MADE IN THE USA

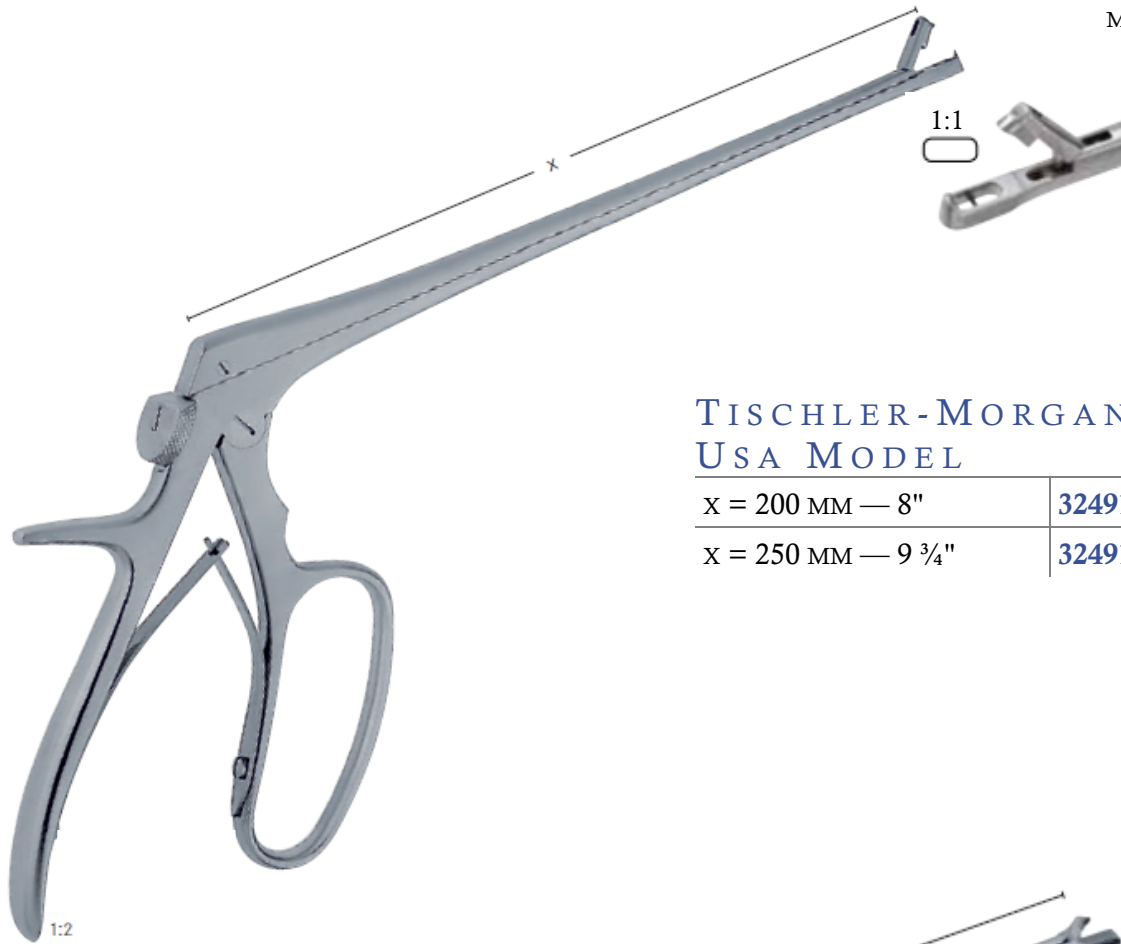

TISCHLER-MORGAN USA MODEL

x = 200 MM — 8"	32491-20
x = 250 MM — 9 3/4"	32491-25

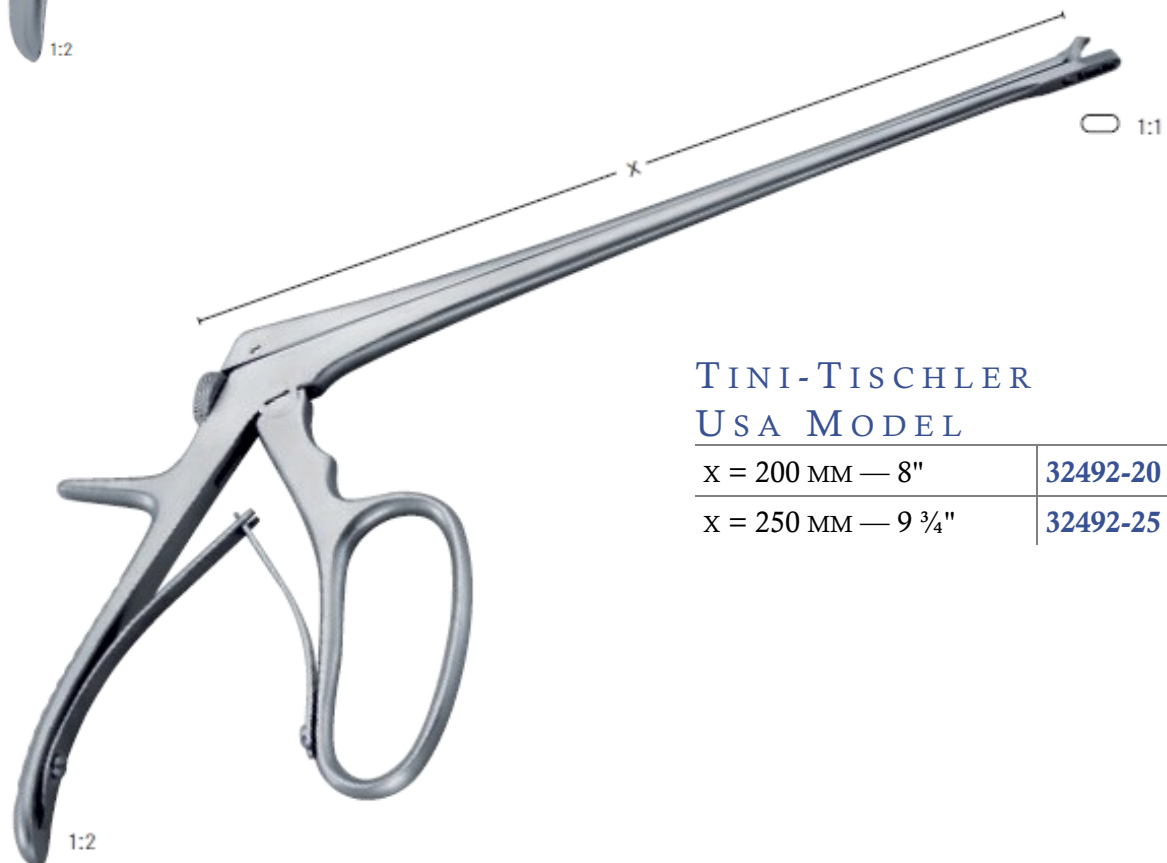

TINI-TISCHLER USA MODEL

x = 200 MM — 8"	32492-20
x = 250 MM — 9 3/4"	32492-25



TO ORDER CALL: (224) 353-6446



BIOPSY CURETTES



MADE IN THE USA



RANDALL - 4MM Ø

240 MM — 9 ½" | **32800-24**



KEVORKIAN

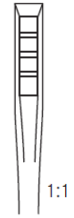

300 MM — 12"	32810-30	32813-30
	RIGID, W/OUT BASKET	RIGID, W/ BASKET
	32811-30	32812-30
	MALLEABLE, W/OUT BASKET	MALLEABLE, W/ BASKET



NOVAK - 4MM Ø

230 MM — 9" | **32805-23**

MINI-NOVAK - 235 MM — 9 ¼"

1 MM Ø	32807-23
2 MM Ø	32808-23
3 MM Ø	32809-23





BIOPSY CURETTES



MADE IN THE USA



SCHULTZE

295MM — 11 1/2" | **32880-00**

*SALPINGOGRAPH, COMPLETE
IN WOODEN CASE*



x = 230 MM — 9" | **32872-00**

FORCEPS FOR I.U.D REMOVING



TO ORDER CALL: (224) 353-6446



ASPIRATING CURETTES



MADE IN THE USA



	295 MM — 11 1/2"
3 MM Ø	32530-03
4 MM Ø	32530-04
6 MM Ø	32530-06
8 MM Ø	32530-08
10 MM Ø	32530-10
12 MM Ø	32530-12
14 MM Ø	32530-14

*SPECIMEN AND ASPIRATING
CURETTE*



120 MM — 4 3/4"	32530-50
-----------------	-----------------

COUPLING PIECE

1:2





UTERINE CURETTES



MADE IN THE USA

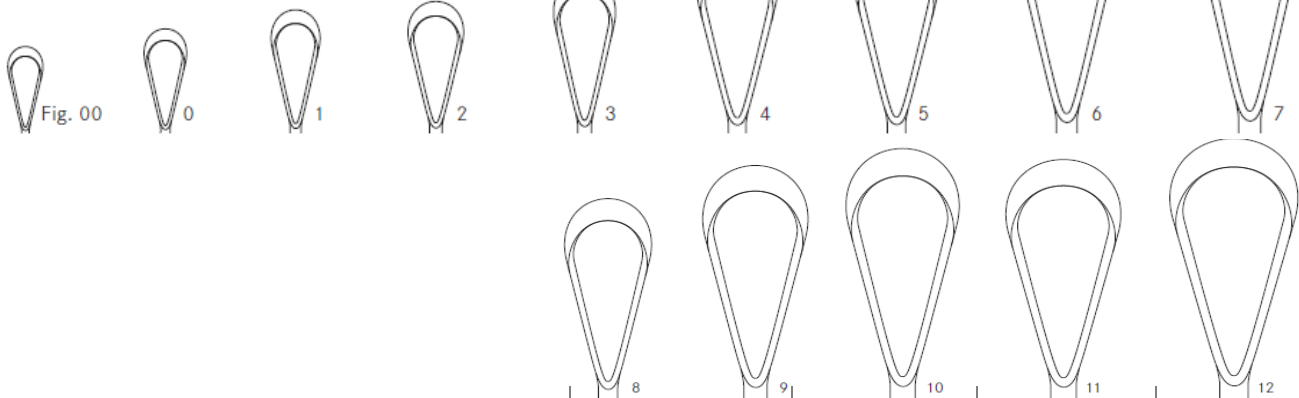

MINI-NOVAK

SHARP, MALLEABLE BLUNT, MALLEABLE SHARP, RIGID BLUNT, RIGID

Y = 260 MM—10 1/4"	FIG.	X=MM				
	00	5	32000-20	32001-20	32002-20	32003-20
	0	6	32000-00	32001-00	32002-00	32003-00
	1	7	32000-01	32001-01	32002-01	32003-01
	2	8	32000-02	32001-02	32002-02	32003-02
	3	9	32000-03	32001-03	32002-03	32003-03
	4	11	32000-04	32001-04	32002-04	32003-04
	5	12	32000-05	32001-05	32002-05	32003-05
	6	14	32000-06	32001-06	32002-06	32003-06
	7	15	32000-07	32001-07	32002-07	32003-07
	8	16	32000-08	32001-08	32002-08	32003-08
	9	19	32000-09	32001-09	32002-09	32003-09
	10	20	32000-10	32001-10	32002-10	32003-10
	11	21	32000-11	32001-11	32002-11	32003-11
	12	23	32000-12	32001-12	32002-12	32003-12
Y = 310 MM—12 1/4"	FIG.	X=MM				
	00	5	32004-20	32005-20	32006-20	32007-20
	0	6	32004-00	32005-00	32006-00	32007-00
	1	7	32004-01	32005-01	32006-01	32007-01
	2	8	32004-02	32005-02	32006-02	32007-02
	3	9	32004-03	32005-03	32006-03	32007-03
	4	11	32004-04	32005-04	32006-04	32007-04
	5	12	32004-05	32005-05	32006-05	32007-05
	6	14	32004-06	32005-06	32006-06	32007-06
	7	15	32004-07	32005-07	32006-07	32007-07
	8	16	32004-08	32005-08	32006-08	32007-08
	9	19	32004-09	32005-09	32006-09	32007-09
	10	20	32004-10	32005-10	32006-10	32007-10
	11	21	32004-11	32005-11	32006-11	32007-11
	12	23	32004-12	32005-12	32006-12	32007-12



TO ORDER CALL: (224) 353-6446



UTERINE CURETTES



MADE IN THE USA

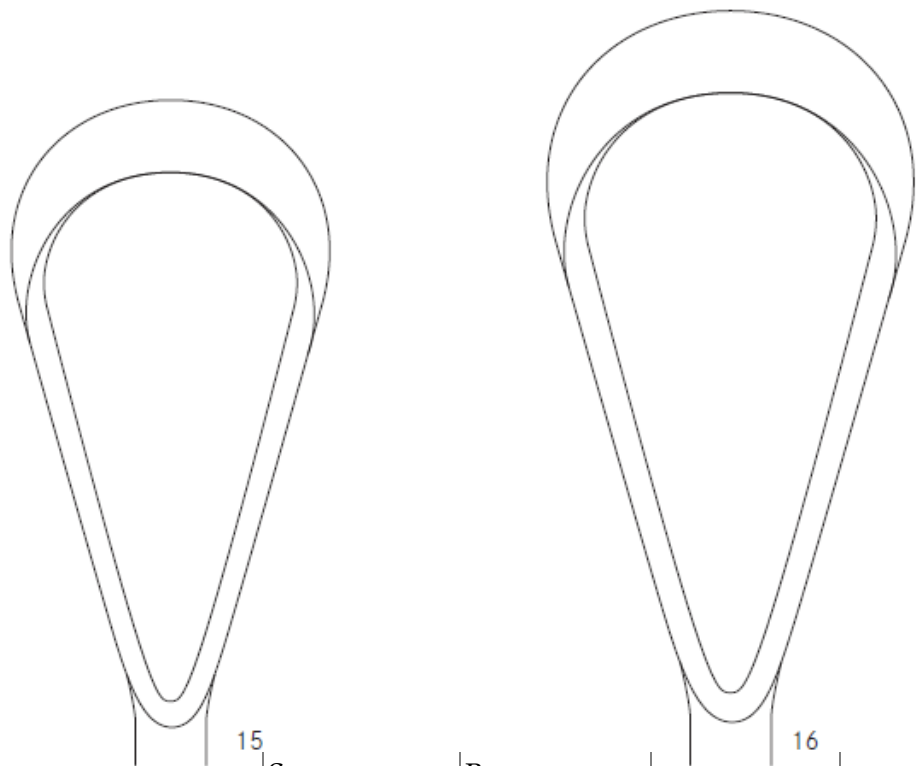
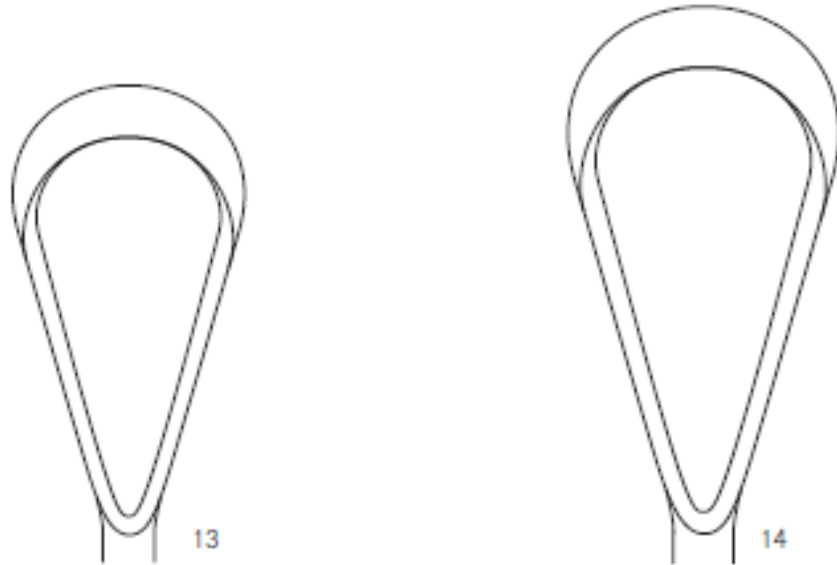

RECAMIER

*SHARP,
MALLEABLE*

*BLUNT,
MALLEABLE*

SHARP, RIGID

BLUNT, RIGID

Y = 340 MM—13 1/2"	FIG.	X=MM				
	13	25	32004-13	32005-13	32006-13	32007-13
	14	30	32004-14	32005-14	32006-14	32007-14
	15	35	32004-15	32005-15	32006-15	32007-15
	16	40	32004-16	32005-16	32006-16	32007-16



WE DESIGN, MANUFACTURE & SELL THE TOOLS THE SURGEONS USE



UTERINE CURETTES



MADE IN THE USA



Fig. 1



Fig. 2



Fig. 3



Fig. 4



Fig. 5



Fig. 6

SIMS

Y = 250 MM— 9
3/4"

FIG.	X=M M				
1	7	32510-01	32511-01	32512-01	32513-01
2	8	32510-02	32511-02	32512-02	32513-02
3	9	32510-03	32511-03	32512-03	32513-03
4	11	32510-04	32511-04	32512-04	32513-04
5	12	32510-05	32511-05	32512-05	32513-05
6	14	32510-06	32511-06	32512-06	32513-06
		<i>SHARP, MALLEABLE</i>	<i>BLUNT, MALLEABLE</i>	<i>SHARP, RIGID</i>	<i>BLUNT, RIGID</i>





UTERINE SPOONS



MADE IN THE USA



SIMON



	FIG. 1	FIG. 2	FIG. 3
250 MM— 9 3/4"	32445-01	32445-02	32445-03
<i>SHARP, RIGID</i>			

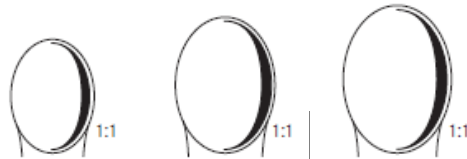

FIG. 4	FIG. 5	FIG. 6
32445-04	32445-05	32445-06



SHRÖDER

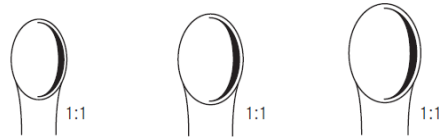

	FIG. 1	FIG. 2	FIG. 3
300 MM— 12"	32448-01	32448-02	32448-03

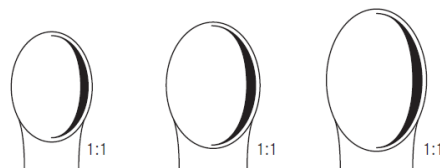

FIG. 4	FIG. 5	FIG. 6
32448-04	32448-05	32448-06





OBSTETRICAL FORCEPS



MADE IN THE USA



SIMPSON

SIMPSON-BRAUN

ELLIOT

PIPER

300 MM — 12"	32600-30	330MM—13"	32602-33	320MM—12 ³ / ₄ "	32604-32	440MM—17 ¹ / ₄ "	32606-44
		360MM—14"	32602-36	380MM—15"	32604-38		



TO ORDER CALL: (224) 353-6446



OBSTETRICAL FORCEPS



MADE IN THE USA



1:3



1:3



1:3



SIMPSON-LUIKART

WRIGLEY

DELEE

DELEE

360 MM — 14 ¼"

32612-36

250 MM —
9 ¾"

32613-23

300 MM —
12"

32615-30

360 MM —
14 ¼"

32618-36

FOR CAESARIAN SECTION

390 MM —
15 ½"

32618-39





OBSTETRICAL FORCEPS



MADE IN THE USA



ELLIOT

MCLEAN

KIELLAND

KIELLAND -

320 MM — 12 ½"	32620-32	360 MM — 14 ¼"	32622-36	410 MM — 16 ¼"	32635-41	400 MM — 16"	32637-40
380 MM — 15"	32620-38						

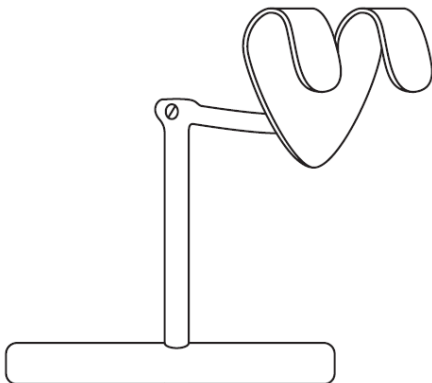

BILL

32640-00

*TRACTION HANDLE FOR ALL THE FORCEPS WITH HORNED
STANDARD HANDLE*



TO ORDER CALL: (224) 353-6446



OBSTETRICS



MADE IN THE USA



SELLHEIM

280 MM — 11" | **32664-28**

OBSTETRIC LEVER



BRAUN

325 MM — 12 3/4" | **32745-30**

DECAPITATING HOOK

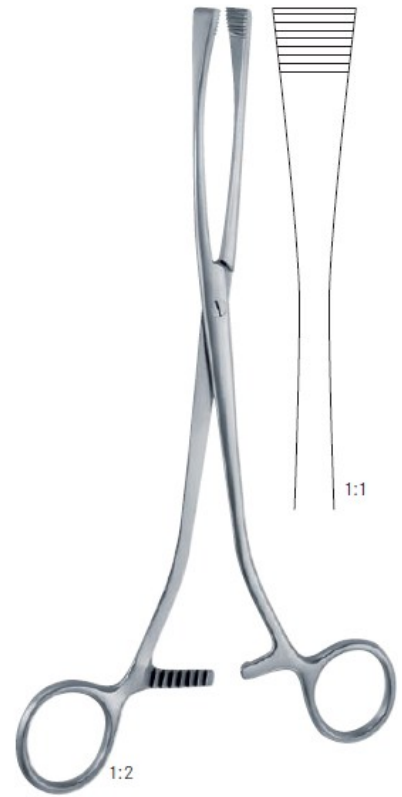

GREEN -

210 MM — 8 1/4" | **32665-21**

UTERINE ELEVATING FORCEPS





OBSTETRICS



MADE IN THE USA



SMELLIE

250 MM — 10"

32741-25

PERFORATOR



BRAUN

420 MM — 16 1/2"

32750-42

*CRANIOCLAST, ONE JAW
FENESTRATED*



TARNIER

460 MM — 17 1/4"

32748-46

BASIOTRIBE



TO ORDER CALL: (224) 353-6446



PELVIMETERS



MADE IN THE USA



MARTIN

340 MM — 13 1/2" **32800-34**

CM / INCH-SCALE



COLLIN

350 MM — 8 3/4" **32805-35**

CM-SCALE

UMBILICAL CORD CLAMP

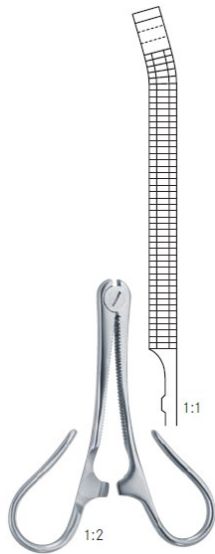

KANE

85 MM — 3 1/4" **32760-08**



COLLIN

90 MM — 3 1/2" **32761-09**



WE DESIGN, MANUFACTURE & SELL THE TOOLS THE SURGEONS USE



NON-CONDUCTIVE INSTRUMENTS



MADE IN THE USA

ELMED INSTRUMENTS INSULATED BLUE NON CONDUCTIVE FOR USE IN LEEP AND OTHER SURGICAL PROCEDURES IN CONJUNCTION WITH RF-APPLICATION.



UNINSULATED TOUCH PAD

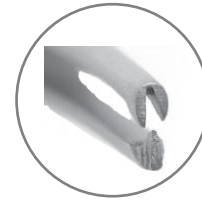

UNINSULATED TOUCH PAD

INSULATED ADSON DRESSING FORCEPS

ITEM No.	DESCRIPTION
32-14-I	4 ³ / ₄ " (12.5CM)

ADSON FORCEPS-TISSUE

ITEM No.	DESCRIPTION
32-16-I	4 ³ / ₄ " (12.5CM)
32-166-I	6" (15.0CM)



UNINSULATED TOUCH PAD



INSULATED DRESSING FORCEPS

	ITEM No. NON-INSULATED TIP	ITEM No. INSULATED TIP
5"	32-150-I	32-150-IT
6"	32-152-I	32-152-IT
7"	32-154-I	32-154-IT
8"	32-156-I	32-156-IT
10"	32-158-I	32-158-IT
12"	32-160-I	32-160-IT



OPTION: INSULATED TOUCH PAD - ADD "P" TO LIST NO.

AUTOCLAVABLE MEDICAL GRADE STAINLESS STEEL AND BLUE NYLON INSULATION



TO ORDER CALL: (224) 353-6446



NON-CONDUCTIVE INSTRUMENTS



MADE IN THE USA



INSULATED POTTS-SMITH DRESSING FORCEPS



	ITEM NO. NON-INSULATED TIP	ITEM NO. INSULATED TIP
7"	32-112-18-I	32-112-18-IT
8"	32-112-21-I	32-112-21-IT
10"	32-112-25-I	32-112-25-IT



UNINSULATED
TOUCH PAD

OPTION: INSULATED TOUCH PAD—ADD LETTER "P" TO LIST NO.



INSULATED POTTS-SMITH DRESSING FORCEPS (1X2 TEETH)



	ITEM NO. NON-INSULATED	ITEM NO. INSULATED TIP
7"	32-126-18-I	32-126-18-IT
8"	32-126-21-I	32-126-21-IT
10"	32-126-25-I	32-126-25-IT



UNINSULATED
TOUCH PAD

AUTOCLAVABLE MEDICAL GRADE STAINLESS STEEL AND BLUE NYLON INSULATION





NON-CONDUCTIVE INSTRUMENTS



MADE IN THE USA

INSULATED DEBAKEY TISSUE FORCEPS



UNINSULATED TOUCH PAD



1.5MM JAW

	NON-INSULATED TIP	INSULATED TIP
6"	32-306-16-I	32-306-16-IT
8"	32-306-20-I	32-306-20-IT
10"	32-306-25-I	32-306-25-IT
12"	32-306-30-I	32-306-30-IT



2.0MM JAW

6"	32-308-16-I	32-308-16-IT
8"	32-308-20-I	32-308-20-IT
10"	32-308-25-I	32-308-25-IT
12"	32-308-30-I	32-308-30-IT



UNINSULATED TOUCH PAD

INSULATED TUTTLE/SINGLEY FORCEPS



	ITEM No. NON-INSULATED	ITEM No. INSULATED TIP
--	---------------------------	---------------------------

TUTTLE STYLE

7"	32-320-18-I	32-320-18-IT
----	--------------------	---------------------

SINGLEY STYLE

	ITEM No.	ITEM No.
9"	32-320-23-I	32-320-23-IT



OPTION: INSULATED TOUCH PAD—ADD LETTER "P" TO LIST NO.

AUTOCLAVABLE MEDICAL GRADE STAINLESS STEEL AND BLUE NYLON INSULATION



TO ORDER CALL: (224) 353-6446



NON-CONDUCTIVE INSTRUMENTS



MADE IN THE USA

INSULATED RING FOERSTER/SCHWEIZER FORCEPS



STRAIGHT OVAL RINGS RATCHET HANDLE

ITEM NO.	
7"	32-170-18-I
8"	32-170-20-I
10"	32-170-25-I
12"	32-170-30-I



CURVED OVAL RINGS RATCHET HANDLE

ITEM NO.	
7"	32-171-18-I
8"	32-171-20-I
10"	32-171-25-I



INSULATED RING CLEMETSON FORCEPS

STRAIGHT OVAL RINGS NON-RATCHET HANDLE

ITEM NO.	
7"	32-172-18-I
8"	32-172-20-I
10"	32-172-25-I
12"	32-172-30-I



INSULATED RING LAUFE UTERINE POLYP FORCEPS

CURVED SMALL OVAL RINGS RATCHET HANDLE

ITEM NO.	
8"	32-173-20-I



INSULATED BOZEMAN

	ITEM NO.	DESCRIPTION
10½"	32-230-26-I	S-CURVED SHAPE
10½"	32-231-26-I	STRAIGHT SHAPE



INSULATED BOZEMAN FORCEPS LARGE RING HANDLE

	ITEM NO.	DESCRIPTION
10½"	32-233-26-I	S-CURVED SHAPE

AUTOCLAVABLE MEDICAL GRADE STAINLESS STEEL AND BLUE NYLON INSULATION





NON-CONDUCTIVE INSTRUMENTS



MADE IN THE USA

INSULATED SCHROEDER TENACULUM FORCEPS SINGLE TOOTH POINTED



POZZI STYLE—ROUND TIP

	ITEM NO.	DESCRIPTION
10"	32-311-26-I	NON-INSULATED TIP
10"	32-311-26-IT	INSULATED TIP

BRAUN STYLE—FLAT TIP

	ITEM NO.	DESCRIPTION
10"	32-610-25-I	NON-INSULATED TIP
10"	32-610-25-IT	INSULATED TIP

INSULATED SCHROEDER TENACULUM FORCEPS DOUBLE TEETH-POINTED



NON-INSULATED TIP

	ITEM NO.	DESCRIPTION
10"	32-314-24-I	STRAIGHT SHAPE
10"	32-315-24-I	CURVED SHAPE

INSULATED TIP

	ITEM NO.	DESCRIPTION
9½"	32-314-24-IT	STRAIGHT SHAPE
9½"	32-315-24-IT	CURVED SHAPE

INSULATED BABCOCK FORCEPS



	ITEM NO.	DESCRIPTION
7"	32-160-18-IT	INSULATED TIP—RATCHET HANDLE
8"	32-160-20-IT	INSULATED TIP—RATCHET HANDLE
9½"	32-160-24-IT	INSULATED TIP—RATCHET HANDLE

INSULATED ALLIS TISSUE FORCEPS – 5X6 TEETH

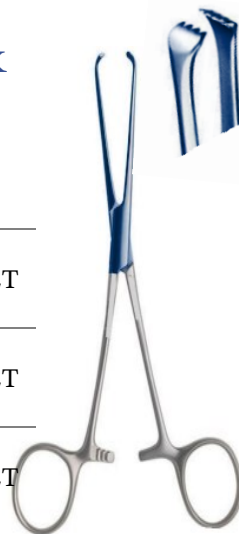

	ITEM NO.	DESCRIPTION
7½"	32-120-19-IT	INSULATED TIP—RATCHET HANDLE
8¾"	32-120-22-IT	INSULATED TIP—RATCHET HANDLE
9½"	32-120-24-IT	INSULATED TIP—RATCHET HANDLE

AUTOCLAVABLE MEDICAL GRADE STAINLESS STEEL AND BLUE NYLON INSULATION



TO ORDER CALL: (224) 353-6446



NON-CONDUCTIVE INSTRUMENTS



MADE IN THE USA



INSULATED CUSHING VEIN RETRACTOR

ITEM NO.	DESCRIPTION
15-17-20-I	7/16" TIP, 7 1/2" OVERALL LENGTH



INSULATED FARABEU F RETRACTOR—SET OF 2

ITEM NO.	DESCRIPTION
15-37-00-I	INNER BLADE 1" X 5/8" / 1 1/8" X 5/8" 5 7/8" OVERALL LENGTH
	OUTER BLADE 1 1/8" X 5/8" / 1/4" X 5/8" 6" OVERALL LENGTH



INSULATED DOYEN RETRACTORS

ITEM NO.	BLADE
32-29-22-I	1 3/4" X 2 1/2"
32-29-23-I	1 3/4" X 3 1/4"
32-29-24-I	2 1/4" X 3 1/4"

AUTOCLAVABLE MEDICAL GRADE STAINLESS STEEL AND BLUE NYLON INSULATION



NON-CONDUCTIVE INSTRUMENTS



MADE IN THE USA



**INSULATED RIGBY
VAGINAL
RETRACTOR**

ITEM NO.	DESCRIPTION
15-53-18-I	3" X 3/4"
15-53-19-I	5" X 3/4"

8" OVERALL LENGTH



**INSULATED GELPI
PERINEAL
RETRACTOR**

ITEM NO.	DESCRIPTION
15-52-18-I	6 3/4" OVERALL LENGTH



**INSULATED
EASTMAN VAGINAL
RETRACTOR**

ITEM NO.	SIZE	DESCRIPTION
32-21-900-I	SMALL	3" X 1 1/2"
32-21-918-I	MEDIUM	3 1/2" X 1 1/2"
32-21-926-I	LARGE	4" X 1 1/2"

7" OVERALL LENGTH



**INSULATED
TAUBER
VAGINAL
SPATULA**

ITEM NO.	DESCRIPTION
32-5176-I	1 3/8" X 3 1/2" BLADE

10" OVERALL LENGTH



**INSULATED
SEGOND
VAGINAL
SPATULA**

ITEM NO.	DESCRIPTION
32-5178-I	1 3/8" X 4 3/4" BLADE

10 1/2" OVERALL LENGTH

AUTOCLAVABLE MEDICAL GRADE STAINLESS STEEL AND BLUE NYLON INSULATION



TO ORDER CALL: (224) 353-6446



NON-CONDUCTIVE INSTRUMENTS



MADE IN THE USA





INSULATED FOMON RETRACTOR DOUBLE BALL TIP

ITEM NO.	DESCRIPTION
32-556-16-I	1/2" X 1/2" - 6 3/4"



INSULATED SENN-MUELLER RETRACTOR

	
SHARP	BLUNT
15-16-16-I	15-16-17-I
5/16 X 1/2" TIP 3/16" X 5/8" BASE	5/16" X 1/2" TIP 3/16" X 5/8" BASE

6 1/4" OVERALL LENGTH



INSULATED RAGNELL-DAVIS RETRACTOR

ITEM NO.	DESCRIPTION
15-15-14-I	3/16" X 3/8" 1/4" X 5/8" TIP

5 1/2" OVERALL LENGTH



INSULATED DEMARRES LID RETRACTORS 5" OVERALL LENGTH

12MM	16MM	18MM
		
32-121-13-I	32-123-13-I	32-124-13-I

AUTOCLAVABLE MEDICAL GRADE STAINLESS STEEL AND BLUE NYLON INSULATION



WE DESIGN, MANUFACTURE & SELL THE TOOLS THE SURGEONS USE



NON-CONDUCTIVE INSTRUMENTS



MADE IN THE USA



INSULATED BRIESKY-NAVRATIL

ITEM NO.	BLADE SIZE	OVERALL LENGTH
32-00-04-I	4" x 1" (100 X 25MM)	12" (30.5CM)
32-00-05-I	4"x1¼" (100 X 30MM)	12" (30.5CM)
32-00-06-I	4"x 1½" (100 X 35MM)	12" (30.5CM)
32-00-07-I	4"x1⅞" (100 X 38MM)	12" (30.5CM)
32-00-08-I	4¾"x 1¼" (120 X 30MM)	12" (30.5CM)
32-00-10-I	5¼"x 1½" (130 X 35MM)	12" (30.5CM)
32-00-11-I	5½"x 1½" (140 X 35MM)	12" (30.5CM)
32-00-12-I	6"x 1½" (150 X 35MM)	12" (30.5CM)
32-00-13-I	6½"x 1½" (160 X 35MM)	12" (30.5CM)
32-00-14-I	6¾"x 1" (170 X 25MM)	12" (30.5CM)

NOT ILLUSTRATED:

SPECIAL BREISKY –NAVRATIL VAGINAL RETRACTOR HEART

32-00-15-I	6¾"x 1" (170 x 25MM)	12" (30.5CM)
-------------------	----------------------	--------------

SMOKE TUBE OPTION FOR ABOVE:

STYLE B—PERMANENT SMOKE EVACUATION TUBE—ADD LETTER "V" TO NUMBER

STYLE C—SLOTTED SMOKE TUBE FOR DISPOSABLE TUBE—ADD LETTER "M" TO NUMBER

BLADE SIZE OF INSTRUMENT ILLUSTRATED

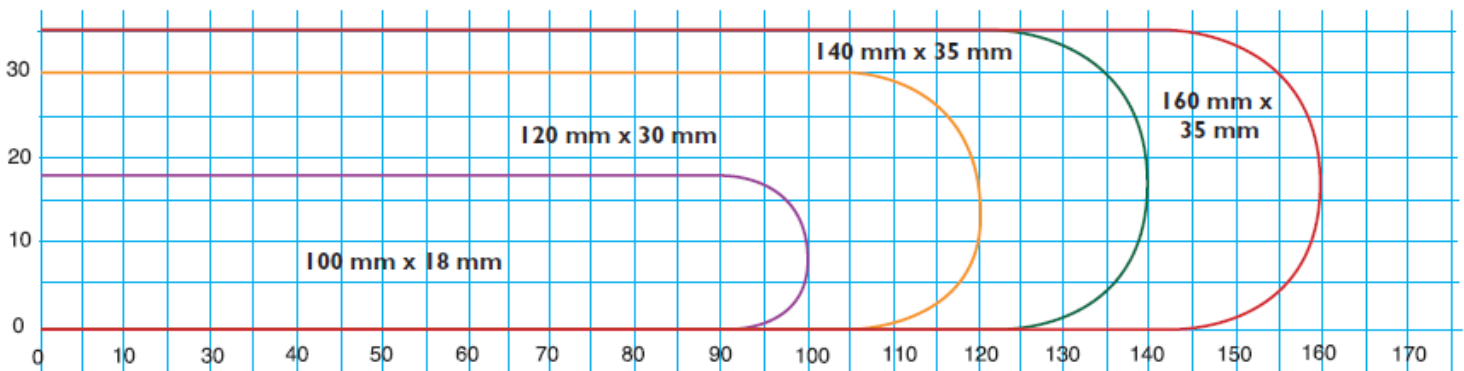

AUTOCALVABLE MEDICAL GRADE STAINLESS STEEL AND BLUE NYLON INSULATION



TO ORDER CALL: (224) 353-6446



NON-CONDUCTIVE INSTRUMENTS



MADE IN THE USA



INSULATED SIMS VAGINAL RETRACTOR— SINGLE END

ITEM NO.	SIZE	BLADE
32-19-11-I	SMALL	2½" x 1 1/16 (63 x 32MM)
32-19-12-I	MEDIUM	3" x 1¼" (76 x 32MM)
32-19-13-I	LARGE	3½" x 1½" (89 x 38MM)

SMOKE TUBE OPTION FOR ABOVE:

STYLE B—PERMANENT SMOKE EVACUATION TUBE—ADD LETTER "V" TO NUMBER

STYLE C—SLOTTED SMOKE TUBE FOR DISPOSABLE TUBE—ADD LETTER "M" TO NUMBER



SIMS VAGINAL RETRACTOR

ITEM NO.	SIZE	BLADE
32-19-01-I	SMALL	2½" x 1" + 3½" x 1¼"
32-19-02-I	MEDIUM	3" x 1⅛" + 3½" x 1¼"
32-19-03-I	LARGE	3½" x 1⅜" + 4" x 1½"



INSULATED JACKSON VAGINAL RETRACTOR— SINGLE END

ITEM NO.	SIZE	BLADE
32-18-01-I	SMALL	3" x 1½" (75 x 38MM)
32-18-02-I	MEDIUM	3½" x 1½" (90 x 38MM)
32-18-03-I	LARGE	4" x 1½" (100 x 38MM)

SMOKE TUBE OPTION FOR ABOVE:

STYLE B—PERMANENT SMOKE EVACUATION TUBE—ADD LETTER "V" TO NUMBER

STYLE C—SLOTTED SMOKE TUBE FOR DISPOSABLE TUBE—ADD LETTER "M" TO NUMBER

AUTOCLAVABLE MEDICAL GRADE STAINLESS STEEL AND BLUE NYLON INSULATION



WE DESIGN, MANUFACTURE & SELL THE TOOLS THE SURGEONS USE



NON-CONDUCTIVE INSTRUMENTS



MADE IN THE USA

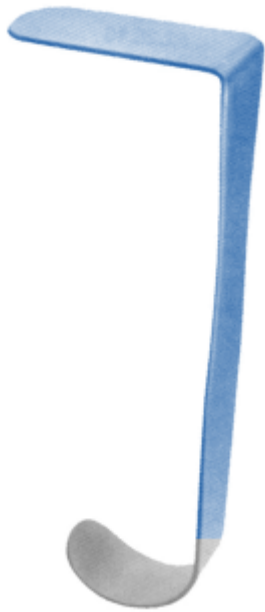

INSULATED HEANEY VAGINAL RETRACTOR

ITEM NO.	SIZE	BLADE
32-23-40-I	SMALL	1 3/4" X 1"
32-23-41-I	MEDIUM	2 7/8" X
32-23-42-I	LARGE	3 1/4" X 1 1/8"

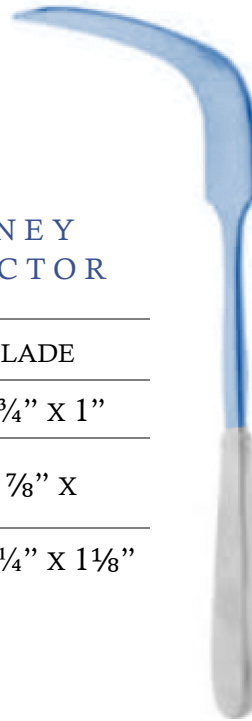

INSULATED HEANEY-SIMON VAGINAL RETRACTOR

ITEM NO.	BLADE
32-23-50-I	4 1/2" X 1"

10 1/2" OVERALL LENGTH



INSULATED RIBBON MALLEABLE RETRACTOR

ITEM NO.	BLADE
15-59-06-I	1/4" X 7"
15-59-10-I	1/2" X 7"
15-59-20-I	3/4" X 13"
15-59-25-I	1" X 13"

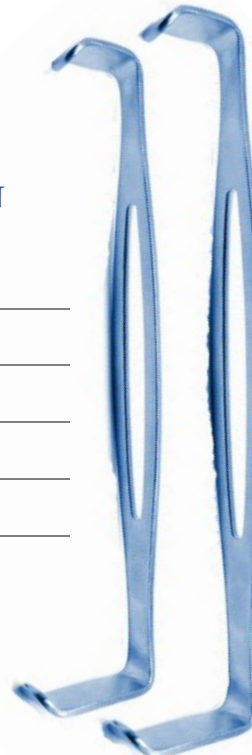

INSULATED US ARMY-NAVY RETRACTOR—SET OF 2

ITEM NO.	BLADE
15-39-00-I	SET OF 2
(A) OUTER BLADE	1" X 5/8" / 2" X 5/8"
8 1/2" OVERALL LENGTH	
(B) INNER BLADE	3/4" X 5/8" / 1 5/8" X 5/8"
8 1/4" OVERALL LENGTH	

AUTOCLAVABLE MEDICAL GRADE STAINLESS STEEL AND BLUE NYLON INSULATION



TO ORDER CALL: (224) 353-6446



NON-CONDUCTIVE INSTRUMENTS



MADE IN THE USA

INSULATED DEAVER RETRACTOR



19MM

ITEM NO.	BLADE
15-35-01-I	3/4" x 7"

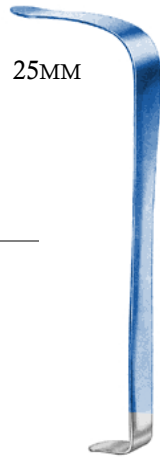

25MM

ITEM NO.	BLADE
15-35-03-I	1" x 9"

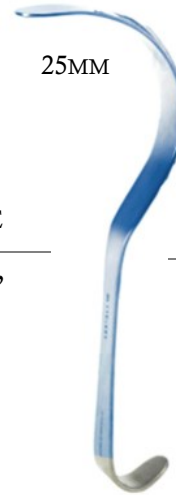

25MM

ITEM NO.	BLADE
15-35-10-I	1" x 12"

INSULATED RICHARDSON RETRACTOR



ITEM NO.	BLADE
15-26-01-I	1" x 3/4" - 9 1/4"



ITEM NO.	BLADE
15-26-02-I	1 1/4" x 1 1/8" - 9 1/4"



ITEM NO.	BLADE
15-26-03-I	1 1/2" x 1 1/2" - 10"
15-26-04-I	2 1/2" x 1 5/8" - 10"



INSULATED RICHARDSON EASTMAN RETRACTOR SET OF 2

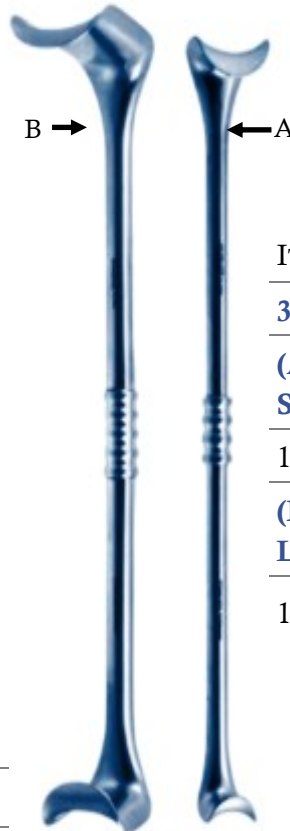

B →

← A

ITEM NO.	BLADE
32-25-00-I	SET OF 2 (A+B)
(A) 32-25-01-I SMALL	1 1/8" x 3/4" / 1 1/2" x 1 1/8"

10" OVERALL LENGTH

(B) 32-25-02-I LARGE	1 3/4" x 1 1/2" / 2 1/2" x 1 5/8"
-------------------------	-----------------------------------

10 1/4" OVERALL LENGTH

AUTOCLAVABLE MEDICAL GRADE STAINLESS STEEL AND BLUE NYLON INSULATION



WE DESIGN, MANUFACTURE & SELL THE TOOLS THE SURGEONS USE



NON-CONDUCTIVE INSTRUMENTS



MADE IN THE USA

INSULATED LATERAL WALL VAGINAL RETRACTOR

THE ELMED LATERAL WALL VAGINAL RETRACTOR RETRACTS THE SIDE WALLS OF THE VAGINAL VAULT OFFERING INCREASED EXPOSURE TO THE CERVIX. THIS RETRACTOR IS DESIGNED AND SHAPED TO FIT INSIDE A STANDARD SPECULUM.



GOLD PLATED RATCHET HANDLE—OPEN SHANKS— 10½” OVERALL LENGTH

ITEM NO.	BLADE SIZE	OVERALL LENGTH
32-16-02-I	2½” x 1”	10½”
32-16-03-I	3½” x 1”	10½”
32-16-04-I	4½” x 1”	10½”



GOLD PLATED SPRING RATCHET HANDLE—CLOSED SHANKS—11” OVERALL LENGTH

ITEM NO.	BLADE SIZE	OVERALL LENGTH
32-16-12-I	2½” x 1”	11”
32-16-13-I	3½” x 1”	11”

AUTOCLAVABLE MEDICAL GRADE STAINLESS STEEL AND BLUE NYLON INSULATION



TO ORDER CALL: (224) 353-6446



NON-CONDUCTIVE INSTRUMENTS



MADE IN THE USA

INSULATED TRU-VIEW™ LATERAL WALL RETRACTOR

THE ELMED TRU-VIEW™ LATERAL WALL RETRACTOR FEATURES LONGER, TAPERED BLADES FOR OPTIMAL CERVICAL EXPOSURE, ACCESS AND PATIENT COMFORT. UNIQUE ARM DESIGN FOR MORE STRENGTH AND SUPPORT, FOR USE WITH THE VU-MORE™ GRAVES & PEDERSON SPECULUM (S—X-LARGE).



GOLD PLATED RATCHET HANDLE—TAPERED BLADES—
12" OVERALL LENGTH

ITEM NO.	BLADE SIZE	OVERALL LENGTH
32-16-24-I	4½" X 1¼"	12"

AUTOCLAVABLE MEDICAL GRADE STAINLESS STEEL AND BLUE NYLON INSULATION





NON-CONDUCTIVE INSTRUMENTS



MADE IN THE USA

ELMED GYN INSTRUMENT INSULATED BLUE NON-CONDUCTIVE FOR USE IN LEEP AND OTHER GYN SURGICAL PROCEDURES IN CONJUNCTION WITH RF-APPLICATION

INSULATED GRAVES VAGINAL SPECULUM—CLOSED SIDE

STYLE A—STANDARD

ITEM NO.	SIZE	BLADE
32-10-01-I	SMALL	3 ³ / ₈ " X 1"
32-10-02-I	MEDIUM	4" X 1 ³ / ₈ "
32-10-03-I	LARGE	4 ³ / ₄ " X 1 ¹ / ₂ "
32-10-04-I	X-LARGE	6" X 1 ¹ / ₂ "
32-10-05-I	XX-LARGE	7" X 1 ¹ / ₂ "



STYLE B—WITH PERMANENT SMOKE EVACUATION TUBE

ITEM NO.	SIZE	BLADE
32-10-01-IV	SMALL	3 ³ / ₈ " X 1"
32-10-02-IV	MEDIUM	4" X 1 ³ / ₈ "
32-10-03-IV	LARGE	4 ³ / ₄ " X 1 ¹ / ₂ "
32-10-04-IV	X-LARGE	6" X 1 ¹ / ₂ "
32-10-05-IV	XX-LARGE	7" X 1 ¹ / ₂ "



STYLE C—WITH SLOTTED SMOKE TUBE FOR DISPOSABLE EVACUATION TUBE

ITEM NO.	SIZE	BLADE
32-10-01-IM	SMALL	3 ³ / ₈ " X 1"
32-10-02-IM	MEDIUM	4" X 1 ³ / ₈ "
32-10-03-IM	LARGE	4 ³ / ₄ " X 1 ¹ / ₂ "
32-10-04-IM	X-LARGE	6" X 1 ¹ / ₂ "
32-10-05-IM	XX-LARGE	7" X 1 ¹ / ₂ "



AUTOCLAVABLE MEDICAL GRADE STAINLESS STEEL AND BLUE NYLON INSULATION



TO ORDER CALL: (224) 353-6446



NON-CONDUCTIVE INSTRUMENTS



MADE IN THE USA

INSULATED PEDERSON VAGINAL SPECULUMS—CLOSED SIDE



STYLE A—STANDARD

ITEM NO.	SIZE	BLADE
32-12-00-I	X-SMALL	2¾" X ½"
32-12-01-I	SMALL	3" X ½"
32-12-02-I	MEDIUM	4" X 7/8"
32-12-03-I	LARGE	4½" X 1"
32-12-04-I	X-LARGE	6" X 1"
32-12-05-I	XX-LARGE	7" X 1"



STYLE B—WITH PERMANENT SMOKE EVACUATION TUBE

ITEM NO.	SIZE	BLADE
32-10-00-IV	X-SMALL	2¾" X ½"
32-10-01-IV	SMALL	3" X ½"
32-10-02-IV	MEDIUM	4" X 7/8"
32-10-03-IV	LARGE	4½" X 1"
32-10-04-IV	X-LARGE	6" X 1"
32-10-05-IV	XX-LARGE	7" X 1"



STYLE C—WITH SLOTTED SMOKE TUBE FOR DISPOSABLE

ITEM NO.	SIZE	BLADE
32-10-00-IM	X-SMALL	2¾" X ½"
32-10-01-IM	SMALL	3" X ½"
32-10-02-IM	MEDIUM	4" X 7/8"
32-10-03-IM	LARGE	4½" X 1"
32-10-04-IM	X-LARGE	6" X 1"
32-10-05-IM	XX-LARGE	7" X 1"

AUTOCLAVABLE MEDICAL GRADE STAINLESS STEEL AND BLUE NYLON INSULATION



WE DESIGN, MANUFACTURE & SELL THE TOOLS THE SURGEONS USE



NON-CONDUCTIVE INSTRUMENTS



MADE IN THE USA

INSULATED WEISMAN GRAVES VAGINAL

STYLE A—STANDARD—ONE SIDE OPEN—90° HANDLE



RIGHT SIDE OPEN			LEFT SIDE OPEN		
ITEM NO.	SIZE	BLADE	ITEM NO.	SIZE	BLADE
32-10-11-I	SMALL	3 ³ / ₈ " X 1"	32-11-11-I	SMALL	3 ³ / ₈ " X 1"
32-10-12-I	MEDIUM	4" X 1 ³ / ₈ "	32-11-12-I	MEDIUM	4" X 1 ³ / ₈ "
32-10-13-I	LARGE	4 ³ / ₄ " X 1 ¹ / ₂ "	32-11-13-I	LARGE	4 ³ / ₄ " X 1 ¹ / ₂ "
32-10-14-I	X-LARGE	6" X 1 ¹ / ₂ "	32-11-14-I	X-LARGE	6" X 1 ¹ / ₂ "

STYLE B—WITH PERMANENT SMOKE EVACUATION TUBE—ONE SIDE OPEN 90° HANDLE



RIGHT SIDE OPEN			LEFT SIDE OPEN		
ITEM NO.	SIZE	BLADE	ITEM NO.	SIZE	BLADE
32-10-11-IV	SMALL	3 ³ / ₈ " X 1"	32-11-11-IV	SMALL	3 ³ / ₈ " X 1"
32-10-12-IV	MEDIUM	4" X 1 ³ / ₈ "	32-11-12-IV	MEDIUM	4" X 1 ³ / ₈ "
32-10-13-IV	LARGE	4 ³ / ₄ " X 1 ¹ / ₂ "	32-11-13-IV	LARGE	4 ³ / ₄ " X 1 ¹ / ₂ "
32-10-14-IV	X-LARGE	6" X 1 ¹ / ₂ "	32-11-14-IV	X-LARGE	6" X 1 ¹ / ₂ "

STYLE C—WITH SLOTTED SMOKE TUBE FOR DISPOSABLE EVACUATION TUBE—ONE SIDE OPEN—90° HANDLE

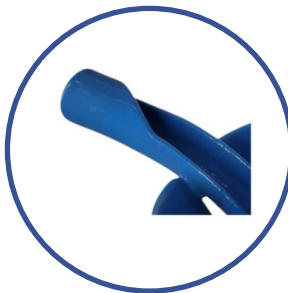

RIGHT SIDE OPEN			LEFT SIDE OPEN		
ITEM NO.	SIZE	BLADE	ITEM NO.	SIZE	BLADE
32-10-11-IM	SMALL	3 ³ / ₈ " X 1"	32-11-11-IM	SMALL	3 ³ / ₈ " X 1"
32-10-12-IM	MEDIUM	4" X 1 ³ / ₈ "	32-11-12-IM	MEDIUM	4" X 1 ³ / ₈ "
32-10-13-IM	LARGE	4 ³ / ₄ " X 1 ¹ / ₂ "	32-11-13-IM	LARGE	4 ³ / ₄ " X 1 ¹ / ₂ "
32-10-14-IM	X-LARGE	6" X 1 ¹ / ₂ "	32-11-14-IM	X-LARGE	6" X 1 ¹ / ₂ "

AUTOCLAVABLE MEDICAL GRADE STAINLESS STEEL AND BLUE NYLON INSULATION



TO ORDER CALL: (224) 353-6446



NON-CONDUCTIVE INSTRUMENTS



MADE IN THE USA



INSULATED WEISMAN GRAVES VAGINAL SPECULUM

STYLE A—STANDARD—ONE SIDE OPEN—45° HANDLE

RIGHT SIDE OPEN			LEFT SIDE OPEN		
ITEM NO.	SIZE	BLADE	ITEM NO.	SIZE	BLADE
32-10-11A-I	SMALL	3 ³ / ₈ " x 1"	32-11-11A-I	SMALL	3 ³ / ₈ " x 1"
32-10-12A-I	MEDIUM	4" x 1 ³ / ₈ "	32-11-12A-I	MEDIUM	4" x 1 ³ / ₈ "
32-10-13A-I	LARGE	4 ³ / ₄ " x 1 ¹ / ₂ "	32-11-13A-I	LARGE	4 ³ / ₄ " x 1 ¹ / ₂ "
32-10-14A-I	X-LARGE	6" x 1 ¹ / ₂ "	32-11-14A-I	X-	6" x 1 ¹ / ₂ "

STYLE B—WITH PERMANENT SMOKE EVACUATION TUBE—ONE SIDE OPEN—45° HANDLE



RIGHT SIDE OPEN			LEFT SIDE OPEN		
ITEM NO.	SIZE	BLADE	ITEM NO.	SIZE	BLADE
32-10-11A-IV	SMALL	3 ³ / ₈ " x 1"	32-11-11A-IV	SMALL	3 ³ / ₈ " x 1"
32-10-12A-IV	MEDIUM	4" x 1 ³ / ₈ "	32-11-12A-IV	MEDIUM	4" x 1 ³ / ₈ "
32-10-13A-IV	LARGE	4 ³ / ₄ " x 1 ¹ / ₂ "	32-11-13A-IV	LARGE	4 ³ / ₄ " x 1 ¹ / ₂ "
32-10-14A-IV	X-LARGE	6" x 1 ¹ / ₂ "	32-11-14A-IV	X-LARGE	6" x 1 ¹ / ₂ "

STYLE C—WITH SLOTTED SMOKE TUBE FOR DISPOSABLE EVACUATION TUBE—ONE SIDE OPEN—45° HANDLE



RIGHT SIDE OPEN			LEFT SIDE OPEN		
ITEM NO.	SIZE	BLADE	ITEM NO.	SIZE	BLADE
32-10-11A-IM	SMALL	3 ³ / ₈ " x 1"	32-11-11A-IM	SMALL	3 ³ / ₈ " x 1"
32-10-12A-IM	MEDIUM	4" x 1 ³ / ₈ "	32-11-12A-IM	MEDIUM	4" x 1 ³ / ₈ "
32-10-13A-IM	LARGE	4 ³ / ₄ " x 1 ¹ / ₂ "	32-11-13A-IM	LARGE	4 ³ / ₄ " x 1 ¹ / ₂ "
32-10-14A-IM	X-LARGE	6" x 1 ¹ / ₂ "	32-11-14A-IM	X-LARGE	6" x 1 ¹ / ₂ "

AUTOCLAVABLE MEDICAL GRADE STAINLESS STEEL AND BLUE NYLON INSULATION



WE DESIGN, MANUFACTURE & SELL THE TOOLS THE SURGEONS USE



NON-CONDUCTIVE INSTRUMENTS



MADE IN THE USA

INSULATED WEISMAN PEDERSON VAGINAL SPECULUM

STYLE A—STANDARD—ONE SIDE OPEN—90° HANDLE



RIGHT SIDE OPEN			LEFT SIDE OPEN		
ITEM NO.	SIZE	BLADE	ITEM NO.	SIZE	BLADE
32-12-11-I	SMALL	3" X ½"	32-13-11-I	SMALL	3" X ½"
32-12-12-I	MEDIUM	4" X ⅞"	32-13-12-I	MEDIUM	4" X ⅞"
32-12-13-I	LARGE	4¾" X 1"	32-13-13-I	LARGE	4¾" X 1"
32-12-14-I	X-LARGE	6" X 1"	32-13-14-I	X-	6" X 1"

STYLE B—WITH PERMANENT SMOKE EVACUATION TUBE—ONE SIDE OPEN—90° HANDLE



RIGHT SIDE OPEN			LEFT SIDE OPEN		
ITEM NO.	SIZE	BLADE	ITEM NO.	SIZE	BLADE
32-12-11-IV	SMALL	3" X ½"	32-13-11-IV	SMALL	3" X ½"
32-12-12-IV	MEDIUM	4" X ⅞"	32-13-12-IV	MEDIUM	4" X ⅞"
32-12-13-IV	LARGE	4¾" X 1"	32-13-13-IV	LARGE	4¾" X 1"
32-12-14-IV	X-LARGE	6" X 1"	32-13-14-IV	X-LARGE	6" X 1"

STYLE C—WITH SLOTTED SMOKE TUBE FOR DISPOSABLE EVACUATION TUBE—ONE SIDE OPEN—90° HANDLE



RIGHT SIDE OPEN			LEFT SIDE OPEN		
ITEM NO.	SIZE	BLADE	ITEM NO.	SIZE	BLADE
32-12-11-IM	SMALL	3" X ½"	32-13-11-IM	SMALL	3" X ½"
32-12-12-IM	MEDIUM	4" X ⅞"	32-13-12-IM	MEDIUM	4" X ⅞"
32-12-13-IM	LARGE	4¾" X 1"	32-13-13-IM	LARGE	4¾" X 1"
32-12-14-IM	X-LARGE	6" X 1"	32-13-14-IM	X-LARGE	6" X 1"

AUTOCLAVABLE MEDICAL GRADE STAINLESS STEEL AND BLUE NYLON INSULATION



TO ORDER CALL: (224) 353-6446



NON-CONDUCTIVE INSTRUMENTS



MADE IN THE USA

INSULATED WEISMAN PEDERSON VAGINAL SPECULUM

STYLE A—STANDARD—ONE SIDE OPEN 45° HANDLE

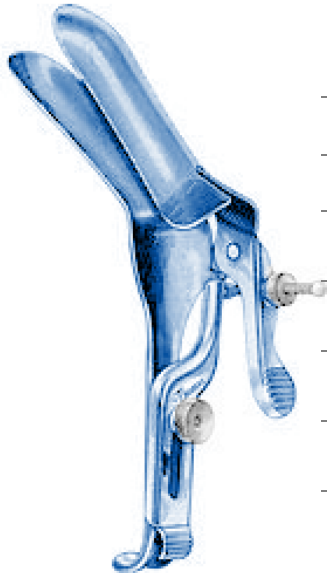

RIGHT SIDE OPEN			LEFT SIDE OPEN		
ITEM NO.	SIZE	BLADE	ITEM NO.	SIZE	BLADE
32-12-11A-I	SMALL	3" X ½"	32-11-11A-I	SMALL	3" X ½"
32-12-12A-I	MEDIUM	4" X ⅞"	32-11-12A-I	MEDIUM	4" X ⅞"
32-12-13A-I	LARGE	4¾" X 1"	32-11-13A-I	LARGE	4¾" X 1"
32-12-14A-I	X-LARGE	6" X 1"	32-11-14A-I	X-LARGE	6" X 1"

STYLE B—WITH PERMANENT SMOKE EVACUATION TUBE—ONE SIDE OPEN—45° HANDLE



RIGHT SIDE OPEN			LEFT SIDE OPEN		
ITEM NO.	SIZE	BLADE	ITEM NO.	SIZE	BLADE
32-12-11A-IV	SMALL	3" X ½"	32-11-11A-IV	SMALL	3" X ½"
32-12-12A-IV	MEDIUM	4" X ⅞"	32-11-12A-IV	MEDIUM	4" X ⅞"
32-12-13A-IV	LARGE	4¾" X 1"	32-11-13A-IV	LARGE	4¾" X 1"
32-12-14A-IV	X-LARGE	6" X 1"	32-11-14A-IV	X-LARGE	6" X 1"

STYLE C—WITH SLOTTED SMOKE TUBE FOR DISPOSABLE EVACUATION TUBE—ONE SIDE OPEN—45° HANDLE



RIGHT SIDE OPEN			LEFT SIDE OPEN		
ITEM NO.	SIZE	BLADE	ITEM NO.	SIZE	BLADE
32-12-11A-IM	SMALL	3" X ½"	32-11-11A-IM	SMALL	3" X ½"
32-12-12A-IM	MEDIUM	4" X ⅞"	32-11-12A-IM	MEDIUM	4" X ⅞"
32-12-13A-IM	LARGE	4¾" X 1"	32-11-13A-IM	LARGE	4¾" X 1"
32-12-14A-IM	X-LARGE	6" X 1"	32-11-14A-IM	X-LARGE	6" X 1"

AUTOCLAVABLE MEDICAL GRADE STAINLESS STEEL AND BLUE NYLON INSULATION



WE DESIGN, MANUFACTURE & SELL THE TOOLS THE SURGEONS USE



NON-CONDUCTIVE INSTRUMENTS



MADE IN THE USA

INSULATED GRAVES VU-MORE™ VAGINAL SPECULUM WITH 1 5/8" WIDE YOKE**



**ALLOWING ENHANCED VIEWING, MANEUVERING AND INSTRUMENT ACCESS

STYLE A—STANDARD

ITEM NO.	SIZE	BLADE
32-19-400-I	SMALL	3 3/8" X 1"
32-19-401-I	MEDIUM	4" X 1 3/8"
32-19-402-I	LARGE	4 3/4" X 1 1/2"
32-19-403-I	X-LARGE	6" X 1 1/2"

STYLE B—WITH PERMANENT SMOKE EVACUATION TUBE



ITEM NO.	SIZE	BLADE
32-19-400-IV	SMALL	3 3/8" X 1"
32-19-401-IV	MEDIUM	4" X 1 3/8"
32-19-402-IV	LARGE	4 3/4" X 1 1/2"
32-19-403-IV	X-LARGE	6" X 1 1/2"

STYLE C—WITH SLOTTED SMOKE TUBE FOR DISPOSABLE EVACUATION TUBE



ITEM NO.	SIZE	BLADE
32-19-400-IM	SMALL	3 3/8" X 1"
32-19-401-IM	MEDIUM	4" X 1 3/8"
32-19-402-IM	LARGE	4 3/4" X 1 1/2"
32-19-403-IM	X-LARGE	6" X 1 1/2"

AUTOCLAVABLE MEDICAL GRADE STAINLESS STEEL AND BLUE NYLON INSULATION



TO ORDER CALL: (224) 353-6446



NON-CONDUCTIVE INSTRUMENTS



MADE IN THE USA

INSULATED PEDERSON VU-MORE™ VAGINAL SPECULUM WITH 1 5/8" WIDE



**ALLOWING ENHANCED VIEWING, MANEUVERING AND INSTRUMENT ACCESS

STYLE A—STANDARD

ITEM NO.	SIZE	BLADE
32-19-410-I	SMALL	3" X 1/2"
32-19-411-I	MEDIUM	4" X 7/8"
32-19-412-I	LARGE	4 1/2" X 1"
32-19-413-I	X-LARGE	6" X 1"

STYLE B—WITH PERMANENT SMOKE EVACUATION TUBE



ITEM NO.	SIZE	BLADE
32-19-410-IV	SMALL	3" X 1/2"
32-19-411-IV	MEDIUM	4" X 7/8"
32-19-412-IV	LARGE	4 1/2" X 1"
32-19-413-IV	X-LARGE	6" X 1"

STYLE C—WITH SLOTTED SMOKE TUBE FOR DISPOSABLE



ITEM NO.	SIZE	BLADE
32-19-410-IM	SMALL	3" X 1/2"
32-19-411-IM	MEDIUM	4" X 7/8"
32-19-412-IM	LARGE	4 1/2" X 1"
32-19-413-IM	X-LARGE	6" X 1"

AUTOCLAVABLE MEDICAL GRADE STAINLESS STEEL AND BLUE NYLON INSULATION



WE DESIGN, MANUFACTURE & SELL THE TOOLS THE SURGEONS USE



NON-CONDUCTIVE INSTRUMENTS



MADE IN THE USA



INSULATED GRAVES WIDE VIEW VU-MAX VAGINAL SPECULUM WITH 2 3/4" SQUARE YOKE**

**ALLOWING ENHANCED VIEWING, MANEUVERING AND INSTRUMENT ACCESS

STYLE A—STANDARD

ITEM NO.	SIZE	BLADE
32-20-403-I	MEDIUM	4" X 1 3/8"
32-20-404-I	LARGE	4 3/4" X 1 1/2"



STYLE B—WITH PERMANENT SMOKE EVACUATION TUBE

ITEM NO.	SIZE	BLADE
32-20-403-IV	MEDIUM	4" X 1 3/8"
32-20-404-IV	LARGE	4 3/4" X 1 1/2"



STYLE C—WITH SLOTTED SMOKE TUBE FOR DISPOSABLE EVACUATION TUBE

ITEM NO.	SIZE	BLADE
32-20-403-IM	MEDIUM	4" X 1 3/8"
32-20-404-IM	LARGE	4 3/4" X 1 1/2"

AUTOCLAVABLE MEDICAL GRADE STAINLESS STEEL AND BLUE NYLON INSULATION



TO ORDER CALL: (224) 353-6446



NON-CONDUCTIVE INSTRUMENTS



MADE IN THE USA



INSULATED PEDERSON WIDE VIEW VU-MAX VAGINAL SPECULUM WITH 2 3/4" SQUARE YOKE**

**ALLOWING ENHANCED VIEWING, MANEUVERING AND INSTRUMENT ACCESS

STYLE A—STANDARD

ITEM NO.	SIZE	BLADE
32-20-413-I	MEDIUM	4" X 7/8"
32-20-414-I	LARGE	4 1/2" X 1"



STYLE B—WITH PERMANENT SMOKE EVACUATION TUBE

ITEM NO.	SIZE	BLADE
32-20-413-IV	MEDIUM	4" X 7/8"
32-20-414-IV	LARGE	4 1/2" X 1"



STYLE C—WITH SLOTTED SMOKE TUBE FOR DISPOSABLE EVACUATION

ITEM NO.	SIZE	BLADE
32-20-413-IM	MEDIUM	4" X 7/8"
32-20-414-IM	LARGE	4 1/2" X 1"

AUTOCLAVABLE MEDICAL GRADE STAINLESS STEEL AND BLUE NYLON INSULATION



WE DESIGN, MANUFACTURE & SELL THE TOOLS THE SURGEONS USE



NON-CONDUCTIVE INSTRUMENTS



MADE IN THE USA



INSULATED MAX VIEW 4 BLADED VAGINAL SPECULUM

STYLE C—WITH SLOTTED SMOKE TUBE FOR DISPOSABLE

ITEM NO.	SIZE
32-15-02-IM	MEDIUM

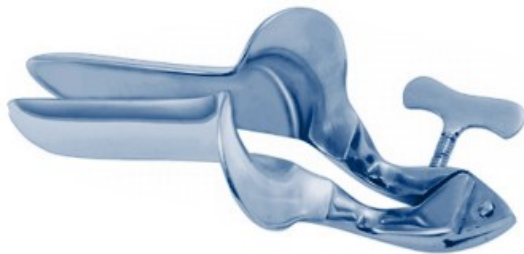

INSULATED COLLIN VAGINAL SPECULUM

STYLE A—STANDARD

ITEM NO.	SIZE	BLADE
32-17-416-I	SMALL	3¾" x 1¼"
32-17-418-I	MEDIUM	4" x 1⅜"
32-17-420-I	LARGE	4½" x 1⅝"



STYLE B—WITH PERMANENT SMOKE EVACUATION TUBE

ITEM NO.	SIZE	BLADE
32-17-416-IV	SMALL	3¾" x 1¼"
32-17-418-IV	MEDIUM	4" x 1⅜"
32-17-420-IV	LARGE	4½" x 1⅝"



STYLE C—WITH SLOTTED SMOKE TUBE FOR DISPOSABLE EVACUATION TUBE

ITEM NO.	SIZE	BLADE
32-17-416-IM	SMALL	3¾" x 1¼"
32-17-418-IM	MEDIUM	4" x 1⅜"
32-17-420-IM	LARGE	4½" x 1⅝"

AUTOCLAVABLE MEDICAL GRADE STAINLESS STEEL AND BLUE NYLON INSULATION



TO ORDER CALL: (224) 353-6446



NON-CONDUCTIVE INSTRUMENTS



MADE IN THE USA



CUSCO VAGINAL SPECULUM

WITH PERMANENT SMOKE EVACUATION TUBE

ITEM NO.	SIZE	BLADE
32-16-01-IV	SMALL	3" X 1¼"
32-16-02-IV	MEDIUM	3½" X 1½"
32-16-03-IV	LARGE	3¾" X 1¾"

INSULATED KOGAN ENDOCERVICAL SPECULUM

TIP 7 X 25MM TIP 3 X 25MM



WITH GAUGE/SCREW SPRING

WITH SPRING HANDLE

W RATCHET HANDLE

32-24-34-I	TIP 7 X 25MM
32-24-35-I	TIP 3 X 25MM

32-25-44-I	TIP 7 X 25MM
32-25-45-I	TIP 3 X 25MM

32-24-24-I	TIP 7 X 25MM
32-24-25-I	TIP 3 X 25MM

AUTOCLAVABLE MEDICAL GRADE STAINLESS STEEL AND BLUE NYLON INSULATION



WE DESIGN, MANUFACTURE & SELL THE TOOLS THE SURGEONS USE



NON-CONDUCTIVE INSTRUMENTS



MADE IN THE USA



INSULATED AUVARD VAGINAL SPECULUM

FEATURING MULTIPLE WEIGHTS AND BLADE SIZES FOR DOWNWARD PULLING FOR MAXIMUM VIEWING

STYLE A—INSULATED STANDARD

ITEM NO.	BLADE & ANGLE	WEIGHT	OVERALL LENGTH
32-22-601-I	3¼" x 1½" - 75°	2 LBS.	9"
32-22-603-I	3½" x 1½" - 75°	2½ LBS.	9"
32-22-605-I	4" x 1¾" - 75°	3 LBS.	9"
32-22-607-I	4" x 1¾" - 45°	2½ LBS.	9"

STYLE B—INSULATED WITH PERMANENT SMOKE EVACUATION TUBE



ITEM NO.	BLADE & ANGLE	WEIGHT	OVERALL LENGTH
32-22-601-IV	3¼" x 1½" - 75°	2 LBS.	9"
32-22-603-IV	3½" x 1½" - 75°	2½ LBS.	9"
32-22-605-IV	4" x 1¾" - 75°	3 LBS.	9"
32-22-607-IV	4" x 1¾" - 45°	2½ LBS.	9"

STYLE C—WITH SLOTTED SMOKE TUBE FOR DISPOSABLE EVACUATION TUBE



ITEM NO.	BLADE & ANGLE	WEIGHT	OVERALL LENGTH
32-22-601-IM	3¼" x 1½" - 75°	2 LBS.	9"
32-22-603-IM	3½" x 1½" - 75°	2½ LBS.	9"
32-22-605-IM	4" x 1¾" - 75°	3 LBS.	9"
32-22-607-IM	4" x 1¾" - 45°	2½ LBS.	9"

AUTOCLAVABLE MEDICAL GRADE STAINLESS STEEL AND BLUE NYLON INSULATION



TO ORDER CALL: (224) 353-6446



NON-CONDUCTIVE INSTRUMENTS



MADE IN THE USA



INSULATED STEINER-AUVARDE VAGINAL SPECULUM

FOR DEEP VAGINAL SURGERY FEATURING 90° SLIGHTLY CURVED BLADE FOR MAXIMUM VIEWING OF THE VAGINAL VAULT

STYLE A—INSULATED STANDARD

ITEM NO.	BLADE & ANGLE	WEIGHT	OVERALL
32-22-652-I	5½" x 1¼" - 90°	2½ Lbs.	9"



STYLE B—INSULATED WITH PERMANENT SMOKE EVACUATION TUBE

ITEM NO.	BLADE & ANGLE	WEIGHT	OVERALL
32-22-652-IV	5½" x 1¼" - 90°	2½ Lbs.	9"



STYLE C—WITH SLOTTED SMOKE TUBE FOR DISPOSABLE EVACUATION TUBE

ITEM NO.	BLADE & ANGLE	WEIGHT	OVERALL LENGTH
32-22-652-IM	5½" x 1¼" - 90°	2½ LBS.	9"

AUTOCLAVABLE MEDICAL GRADE STAINLESS STEEL AND BLUE NYLON INSULATION



WE DESIGN, MANUFACTURE & SELL THE TOOLS THE SURGEONS USE



NON-CONDUCTIVE INSTRUMENTS



MADE IN THE USA



INSULATED COMPACT WEIGHTED “E”

COMPACT WITH COMFORT GRIP HANDLE AND CONCAVE BLADE WITH RIGHT ANGLE TIP FOR MAXIMUM PATIENT COMFORT

STYLE A—INSULATED STANDARD

ITEM NO.	BLADE	WEIGHT	OVERALL LENGTH
32-23-15-I	3¾” x 1½”	1½ LBS.	10”
32-23-16-I	3¾” x 1½”	2½” LBS.	11”
32-23-17-I	3¾” x 1½”	3 LBS.	12”



STYLE B—INSULATED WITH PERMANENT SMOKE EVACUATION TUBE

ITEM NO.	BLADE	WEIGHT	OVERALL
32-23-15-IV	3¾” x 1½”	1½ LBS.	10”
32-23-16-IV	3¾” x 1½”	2½ LBS.	11”
32-23-17-IV	3¾” x 1½”	3 LBS.	12”



STYLE C—WITH SLOTTED SMOKE TUBE FOR DISPOSABLE EVACUATION

ITEM NO.	BLADE	WEIGHT	OVERALL
32-23-15-IM	3¾” x 1½”	1½ LBS.	10”
32-23-16-IM	3¾” x 1½”	2½ LBS.	11”
32-23-17-IM	3¾” x 1½”	3 LBS.	12”

AUTOCLAVABLE MEDICAL GRADE STAINLESS STEEL AND BLUE NYLON INSULATION



TO ORDER CALL: (224) 353-6446



NON-CONDUCTIVE INSTRUMENTS



MADE IN THE USA



INSULATED COMPACT HEANEY STYLE

COMPACT WITH COMFORT GRIP HANDLE AND FLAT ANGLED BLADE FOR MAXIMUM PATIENT COMFORT

STYLE A—INSULATED STANDARD

ITEM NO.	BLADE & ANGLE	WEIGHT	OVERALL LENGTH
32-23-34-I	4" x 1" - 45°	3 LBS.	13½"



STYLE B—INSULATED WITH PERMANENT SMOKE EVACUATION TUBE

ITEM NO.	BLADE & ANGLE	WEIGHT	OVERALL LENGTH
32-23-34-IV	4" x 1" - 45°	3 LBS.	13½"



STYLE C—WITH SLOTTED SMOKE TUBE FOR DISPOSABLE EVACUATION TUBE

ITEM NO.	BLADE & ANGLE	WEIGHT	OVERALL LENGTH
32-23-34-IM	4" x 1" - 45°	3 LBS.	13½"

AUTOCLAVABLE MEDICAL GRADE STAINLESS STEEL AND BLUE NYLON INSULATION





NON-CONDUCTIVE INSTRUMENTS



MADE IN THE USA

ELMED INSULATED-NON CONDUCTIVE STAINLESS STEEL VAGINAL DILATOR

CUSTOM STAINLESS STEEL INSULATED-NON CONDUCTIVE VAGINAL DILATORS WITH SMOOTH CURVED TIP FOR COMFORTABLE INSERTION AND BASE WITH GROOVES ON HANDLE FOR ANTI-SLIP CONTROL FOR USE IN CONJUNCTION WITH RF-APPLICATION.

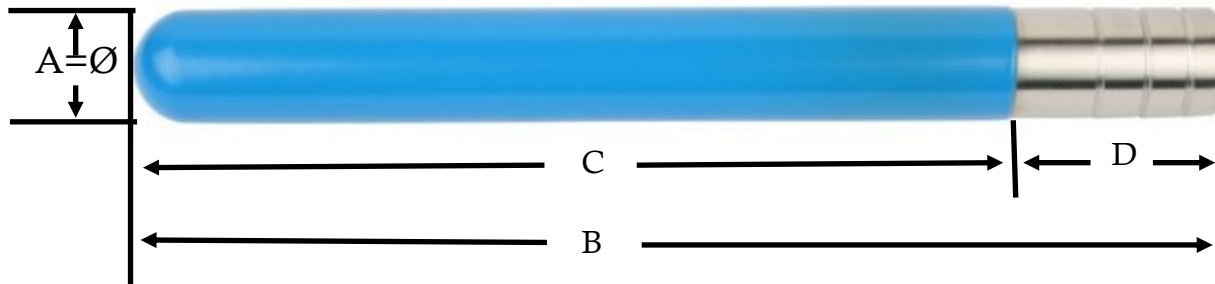

- (A) DIAMETER OF INSTRUMENT PER ITEM NO.
- (B) OVERALL LENGTH PER ITEM NO.
- (C) INSULATED-NON CONDUCTIVE TIP + SHAFT—ALL 9¾” (24.8CM) LENGTH
- (D) UNINSULATED GROOVED HANDLE—ALL 2” (5.1CM) LENGTH

ITEM NO.	DESCRIPTION
32-5001-I	(A)-¾” (1.9 CM) DIA. x (B)- 11¾” (30CM) OVERALL LENGTH. INSULATED-NON CONDUCTIVE STAINLESS STEEL VAGINAL DILATOR
32-5002-I	(A)-1” (2.5 CM) DIA. x (B)- 11¾” (30CM) OVERALL LENGTH. INSULATED-NON CONDUCTIVE STAINLESS STEEL VAGINAL DILATOR
32-5003-I	(A)-1¼” (3.18CM) DIA. x (B)- 11¾” (30CM) OVERALL LENGTH. INSULATED-NON CONDUCTIVE STAINLESS STEEL VAGINAL DILATOR
32-5004-I	(A)-1½” (3.8 CM) DIA. x (B)- 11¾” (30CM) OVERALL LENGTH. INSULATED-NON CONDUCTIVE STAINLESS STEEL VAGINAL DILATOR
32-5005-I	(A)-1¾” (4.45CM) DIA. x (B)- 11¾” (30CM) OVERALL LENGTH. INSULATED-NON CONDUCTIVE STAINLESS STEEL VAGINAL DILATOR





NON-CONDUCTIVE INSTRUMENTS



MADE IN THE USA





INSULATED IRIS HOOKS QUICK RELEASE



	STYLE #1
1MM DIA.	
	STYLE #2
3MM DIA.	
	STYLE#3
4MM DIA.	
	STYLE #4
6MM DIA.	

INSULATED EMMETT HOOKS



	STYLE #1
	STYLE #2
	STYLE#3
	STYLE #4
	STYLE #5

ITEM NO.	TIP SIZE	OVERALL LENGTH
32-509-01-I	1MM	9"
32-509-03-I	3MM	9"
32-509-04-I	4MM	9"
32-509-06-I	6MM	9"
32-512-01-I	1MM	12"
32-512-03-I	3MM	12"
32-512-04-I	4MM	12"
32-512-06-I	6MM	12"

ITEM NO.	STYLE	OVERALL LENGTH
32-958-01-I	1	9"
32-958-02-I	2	9"
32-958-03-I	3	9"
32-958-04-I	4	9"
32-958-05-I	5	9"

STANDARD INSULATION. COMPLETE INSULATION WITH 2MM TIP EXPOSED.

AUTOCLAVABLE MEDICAL GRADE STAINLESS STEEL AND BLUE NYLON INSULATION



WE DESIGN, MANUFACTURE & SELL THE TOOLS THE SURGEONS USE



NON-CONDUCTIVE INSTRUMENTS



MADE IN THE USA

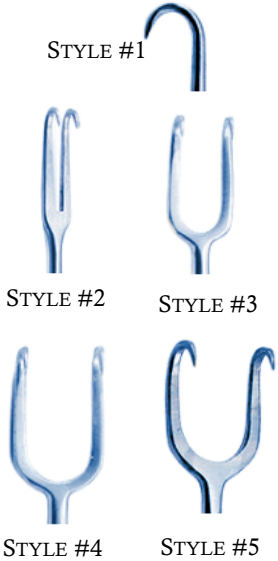

INSULATED JOSEPH SKIN HOOKS



STYLE NO.	ITEM NO./O.L.	ITEM NO./O.L.
1—PRONG	32-216-01-I / 1¼"	32-219-01-I / 9"
2—2MM/ 2 PRONG	32-216-02-I / 6¼"	32-219-02-I / 9"
3—5MM/ 2 PRONG	32-216-05-I / 6¼"	32-219-05-I / 9"
4—7MM/ 2 PRONG	32-216-07-I / 6¼"	32-219-07-I / 9"
5—10MM/ 2 PRONG	32-216-10-I / 6¼"	32-219-10-I / 9"



INSULATED THREE PRONG HOOK

ITEM NO.	DESCRIPTION
32-803-26-I	10¼" OVERALL LENGTH

INSULATED GUTHRIE DOUBLE HOOKS SHARP, 5" OVERALL LENGTH

3MM—2 SMALL PRONG	5MM—LARGE PRONG
	
32-212-01-I	32-212-02-I





NON-CONDUCTIVE INSTRUMENTS



MADE IN THE USA



INSULATED LEEP RULERS

INSULATED LEEP DEEP RULER		INSULATED LEEP WIDTH RULER	
			
ITEM NO.	DESCRIPTION	ITEM NO.	DESCRIPTION
32-600-24-I	240MM WORKING LENGTH	32-610-21-I	210MM WORKING LENGTH





LASER BLACK INSTRUMENTS



MADE IN THE USA

ELMED INSTRUMENTS COATED LASER BLACK FOR USE IN CONJUNCTION WITH LASER APPLICATION.



LASER BLACK ADSON DRESSING FORCEPS

ITEM NO.	DESCRIPTION
32-14-E	4¾" (12.5CM)
32-146-I	6" (15.0 CM)



LASER BLACK FORCEPS-TISSUE (1X2 TEETH)

ITEM NO.	DESCRIPTION
32-14-E	4¾" (12.5CM)
32-166-E	6" (15.0 CM)



LASER BLACK DRESSING FORCEPS

	ITEM NO. INSULATED TIP
5"	32-150-E
6"	32-152-E
7"	32-154-E
8"	32-156-E
10"	32-158-E
12"	32-160-E



AUTOCLAVABLE MEDICAL GRADE STAINLESS STEEL AND LASER BLACK COATING



TO ORDER CALL: (224) 353-6446



LASER BLACK INSTRUMENTS



MADE IN THE USA



LASER BLACK POTTS-SMITH DRESSING FORCEPS

	ITEM NO.
7"	32-112-18-E
8"	32-112-21-E
10"	32-112-25-E

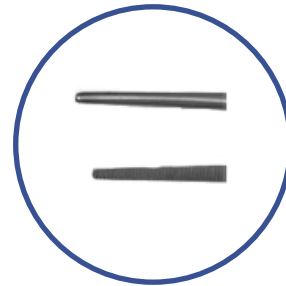

LASER BLACK POTTS-SMITH DRESSING FORCEPS (1X2 TEETH)

	ITEM NO. INSULATED TIP
7"	32-126-18-E
8"	32-126-21-E
10"	32-126-25-E



AUTOCLAVABLE MEDICAL GRADE STAINLESS STEEL AND LASER BLACK COATING





LASER BLACK INSTRUMENTS



MADE IN THE USA



LASER BLACK DEBAKEY TISSUE FORCEPS



1.5MM JAW		2.0MM JAW	
	ITEM NO.		ITEM NO.
6"	32-306-16-E	6"	32-308-16-E
8"	32-306-20-E	8"	32-308-20-E
10"	32-306-25-E	10"	32-308-25-E
12"	32-306-30-E	12"	32-308-30-E



LASER BLACK TUTTLE/SINGLEY FORCEPS

TUTTLE STYLE

ITEM NO.	DESCRIPTION
32-320-18-E	7"

SINGLEY STYLE

ITEM NO.	DESCRIPTION
32-320-23-E	9"

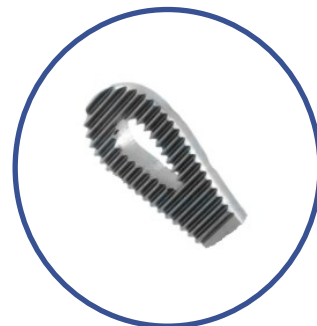

AUTOCLAVABLE MEDICAL GRADE STAINLESS STEEL AND LASER BLACK COATING



TO ORDER CALL: (224) 353-6446



LASER BLACK INSTRUMENTS



MADE IN THE USA

LASER BLACK RING FOERSTER/SCHWEIZER FORCEPS



STRAIGHT OVAL RINGS RATCHET HANDLE

	ITEM NO.
7"	32-170-18-E
8"	32-170-20-E
10"	32-170-25-E
12"	32-170-30-E



CURVED OVAL RINGS RATCHET HANDLE

	ITEM NO.
7"	32-171-18-E
8"	32-171-20-E
10"	32-171-25-E

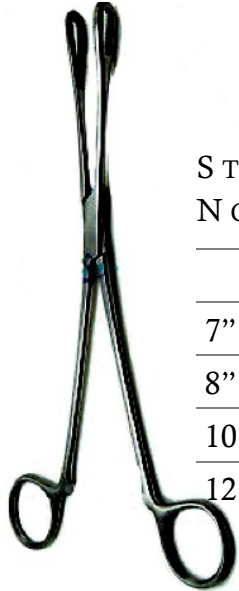

LASER BLACK RING CLEMETSON FORCEPS

STRAIGHT OVAL RINGS NON-RATCHET HANDLE

	ITEM NO.
7"	32-172-18-E
8"	32-172-20-E
10"	32-172-25-E
12"	32-172-30-E

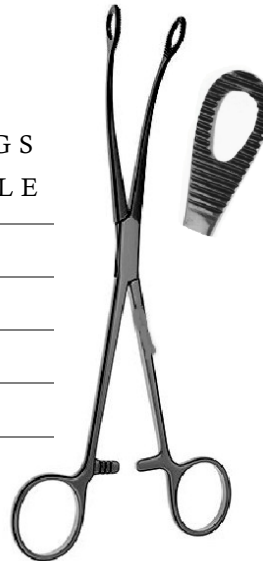

LASER BLACK RING LAUFE UTERINE POLYP FORCEPS

CURVED SMALL OVAL RING RATCHET HANDLE

	ITEM NO.
8"	32-173-20-E



LASER BLACK BOZEMAN FORCEPS

	ITEM NO.	DESCRIPTION
10½"	32-230-26-E	S-CURVED SHAPE
10½"	32-231-26-E	STRAIGHT SHAPE



LASER BLACK BOZEMAN FORCEPS LARGE RING HANDLE

	ITEM NO.	DESCRIPTION
10½"	32-233-26-E	S-CURVED SHAPE

AUTOCLAVABLE MEDICAL GRADE STAINLESS STEEL AND LASER BLACK COATING





LASER BLACK INSTRUMENTS



MADE IN THE USA

LASER BLACK SCHROEDER TENACULUM FORCEPS SINGLE TOOTH POINTED



POZZI STYLE—ROUND TIP		
	ITEM NO.	DESCRIPTION
10"	32-311-26-E	INSULATED TIP

BRAUN STYLE—FLAT TIP		
	ITEM NO.	DESCRIPTION
10"	32-610-25-E	INSULATED TIP

LASER BLACK SCHROEDER TENACULUM FORCEPS DOUBLE TEETH-POINTED



	ITEM NO.	DESCRIPTION
10"	32-314-24-E	STRAIGHT SHAPE
10"	32-315-24-E	CURVED SHAPE

LASER BLACK BABCOCK FORCEPS

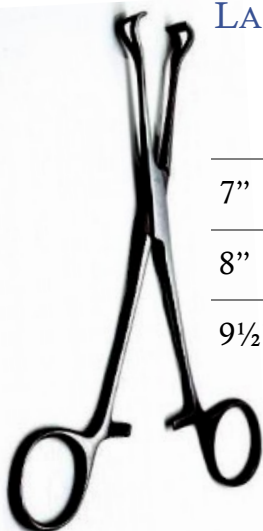

	ITEM NO.	DESCRIPTION
7"	32-160-18-E	RATCHET HANDLE
8"	32-160-20-E	RATCHET HANDLE
9½"	32-160-24-E	RATCHET HANDLE

LASER BLACK ALLIS TISSUE FORCEPS —5X6 TEETH



	ITEM NO.	DESCRIPTION
7 ½"	32-120-19-E	RATCHET HANDLE
8 ¾"	32-120-22-E	RATCHET HANDLE
9 ½"	32-120-24-E	RATCHET HANDLE

AUTOCLAVABLE MEDICAL GRADE STAINLESS STEEL AND LASER BLACK COATING



TO ORDER CALL: (224) 353-6446



LASER BLACK INSTRUMENTS



MADE IN THE USA

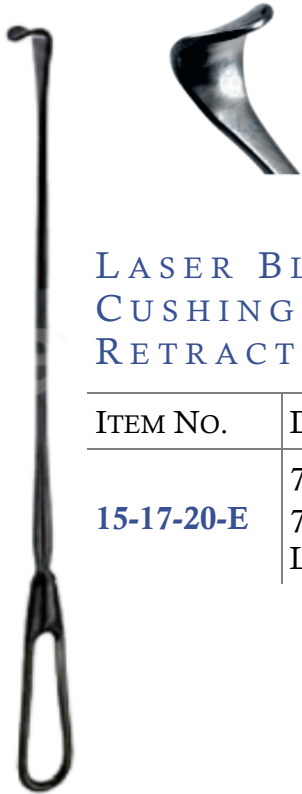

LASER BLACK
CUSHING VEIN
RETRACTOR

ITEM NO.	DESCRIPTION
15-17-20-E	7/16" TIP 7 1/2" OVERALL LENGTH



LASER BLACK
FARABEU F RETRACTOR
SET OF 2

ITEM NO.	DESCRIPTION
15-37-00-E	INNER BLADE 1" X 5/8" / 1 1/8" X 5/8" 5 7/8" OVERALL LENGTH
	OUTER BLADE 1 1/8" X 5/8" / 1/4" X 5/8" 6" OVERALL LENGTH



LASER BLACK
DOYEN RETRACTOR

ITEM NO.	BLADE
32-29-22-E	1 3/4" X 2 1/2"
32-29-23-E	1 3/4" X 3 1/4"
32-29-24-E	2 1/4" X 3 1/4"



LASER BLACK DESMARRES
LID RETRACTORS
5" OVERALL LENGTH

12MM	16MM	18MM
		
32-121-13-E	32-123-13-E	32-124-13-E

AUTOCLAVABLE MEDICAL GRADE STAINLESS STEEL AND LASER BLACK COATING



WE DESIGN, MANUFACTURE & SELL THE TOOLS THE SURGEONS USE



LASER BLACK INSTRUMENTS



MADE IN THE USA



LASER BLACK RIGBY VAGINAL RETRACTOR

ITEM NO.	DESCRIPTION
15-53-18-E	3" X 3/4" BLADE
15-53-19-E	5" X 3/4" BLADE

8" OVERALL LENGTH



LASER BLACK GELPI PERINEAL RETRACTOR

ITEM NO.	DESCRIPTION
15-52-18-E	6 3/4" OVERALL LENGTH



LASER BLACK EASTMAN VAGINAL RETRACTOR

ITEM NO.	SIZE	DESCRIPTION
32-21-900-E	SMALL	3" X 1 1/2"
32-21-918-E	MEDIUM	3 1/2" X 1 1/2"
32-21-926-E	LARGE	4" X 1 1/2"

7" OVERALL LENGTH



LASER BLACK TAUBER VAGINAL SPATULA

ITEM NO.	DESCRIPTION
32-5176-E	1 3/8" X 3 1/2" BLADE

10" OVERALL LENGTH



LASER BLACK SEGOND VAGINAL SPATULA

ITEM NO.	DESCRIPTION
32-5178-E	1 3/8" X 4 3/4" BLADE

10 1/2" OVERALL LENGTH

AUTOCLAVABLE MEDICAL GRADE STAINLESS STEEL AND LASER BLACK COATING



TO ORDER CALL: (224) 353-6446



LASER BLACK INSTRUMENTS



MADE IN THE USA





LASER BLACK FOMON RETRACTOR DOUBLE BALL TIP

ITEM NO.	DESCRIPTION
32-556-16-E	1/2" X 1/2" - 6 3/4" BLADE



LASER BLACK SENN-MUELLER RETRACTOR

	
SHARP	BLUNT
15-16-16-E	15-16-17-E
5/16 X 1/2" TIP 3/16" X 5/8" BASE	5/16" X 1/2" TIP 3/16" X 5/8" BASE

6 1/4" OVERALL LENGTH

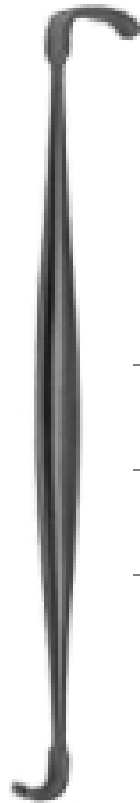

LASER BLACK RAGNELL-DAVIS RETRACTOR

ITEM NO.	DESCRIPTION
15-15-14-E	3/16" X 3/8" 1/4" X 5/8" TIP

5 1/2" OVERALL LENGTH

AUTOCLAVABLE MEDICAL GRADE STAINLESS STEEL AND LASER BLACK COATING



WE DESIGN, MANUFACTURE & SELL THE TOOLS THE SURGEONS USE



MADE IN THE USA

LASER BLACK INSTRUMENTS

LASER BLACK BRIESKY-NAVRATIL VAGINAL RETRACTOR



ITEM NO.	BLADE SIZE	OVERALL LENGTH
32-00-04-E	4" x 1" (100 X 25MM)	12" (30.5CM)
32-00-05-E	4" x 1¼" (100 X 30MM)	12" (30.5CM)
32-00-06-E	4" x 1½" (100 X 35MM)	12" (30.5CM)
32-00-07-E	4" x 1⅞" (100 X 38MM)	12" (30.5CM)
32-00-08-E	4¾" x 1¼" (120 X 30MM)	12" (30.5CM)
32-00-10-E	5¼" x 1½" (130 X 35MM)	12" (30.5CM)
32-00-11-E	5½" x 1½" (140 X 35MM)	12" (30.5CM)
32-00-12-E	6" x 1½" (150 X 35MM)	12" (30.5CM)
32-00-13-E	6½" x 1½" (160 X 35MM)	12" (30.5CM)
32-00-14-E	6¾" x 1" (170 X 25MM)	12" (30.5CM)

NOT ILLUSTRATED:

SPECIAL BREISKY-NAVRATIL VAGINAL RETRACTOR HEART SHAPED TIP BLADE—LASER BLACK

32-00-15-E	6¾" X 1" (170 X 25MM)	12" (30.5CM)
-------------------	-----------------------	--------------

SMOKE TUBE OPTION FOR ABOVE:

STYLE B—PERMANENT SMOKE EVACUATION TUBE—ADD LETTER "V" TO NUMBER

STYLE C—SLOTTED SMOKE TUBE FOR DISPOSABLE TUBE—ADD LETTER "M" TO NUMBER

BLADE SIZE OF INSTRUMENT ILLUSTRATED

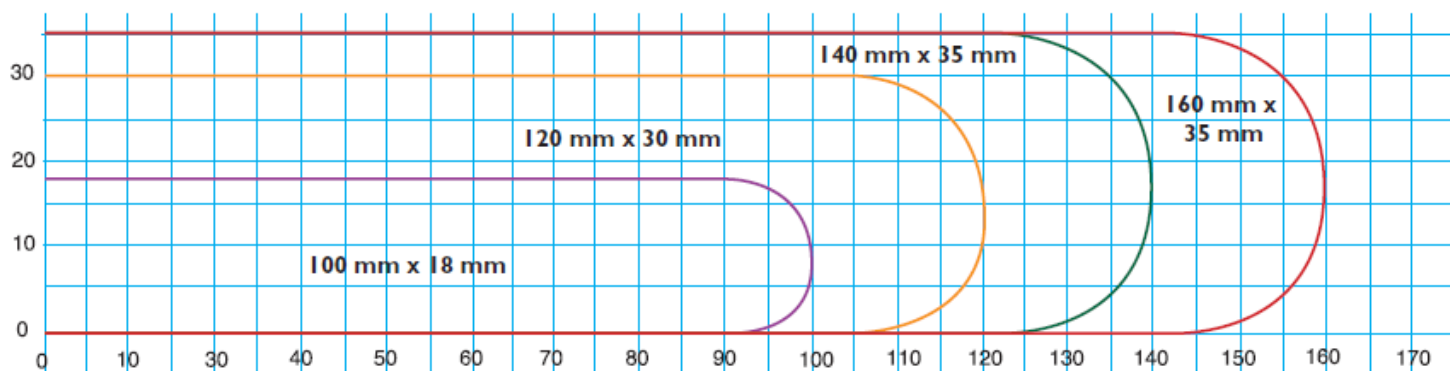

AUTOCLAVABLE MEDICAL GRADE STAINLESS STEEL AND LASER BLACK COATING



TO ORDER CALL: (224) 353-6446



LASER BLACK INSTRUMENTS



MADE IN THE USA

LASER BLACK SIMS VAGINAL RETRACTORS— SINGLE END

ITEM NO.	SIZE	BLADE
32-19-11-E	SMALL	2½" x 1 1/16 (63 x 32MM)
32-19-12-E	MEDIUM	3" x 1¼" (76 x 32MM)
32-19-13-E	LARGE	3½" x 1½" (89 x 38MM)

SMOKE TUBE OPTION FOR ABOVE:

STYLE B—PERMANENT SMOKE EVACUATION TUBE—ADD LETTER "V" TO NUMBER

STYLE C—SLOTTED SMOKE TUBE FOR DISPOSABLE TUBE—ADD LETTER "M" TO NUMBER

LASER BLACK SIMS VAGINAL RETRACTORS—DOUBLE END

ITEM NO.	SIZE	BLADE
32-19-01-E	SMALL	2½" x 1" + 3½" x 1¼"
32-19-02-E	MEDIUM	3" x 1½" + 3½" x 1¼"
32-19-03-E	LARGE	3½" x 1¾" + 4" x 1½"

LASER BLACK JACKSON RETRACTORS

ITEM NO.	SIZE	BLADE
32-18-01-E	SMALL	3" x 1½" (75 x 38MM)
32-18-02-E	MEDIUM	3½" X 1½" (90 x 38MM)
32-18-03-E	LARGE	4" X 1½" (100 x 38MM)

SMOKE TUBE OPTION FOR ABOVE:

STYLE B—PERMANENT SMOKE EVACUATION TUBE—ADD LETTER "V" TO NUMBER

STYLE C—SLOTTED SMOKE TUBE FOR DISPOSABLE TUBE—ADD LETTER "M" TO NUMBER

AUTOCLAVABLE MEDICAL GRADE STAINLESS STEEL AND LASER BLACK COATING



WE DESIGN, MANUFACTURE & SELL THE TOOLS THE SURGEONS USE



LASER BLACK INSTRUMENTS



MADE IN THE USA



LASER BLACK HEANEY VAGINAL RETRACTOR

ITEM NO.	SIZE	BLADE
32-23-40-E	SMALL	1 3/4" X 1"
32-23-41-E	MEDIUM	2 7/8" X 1 1/8"
32-23-42-E	LARGE	3 1/4" X 1 1/8"

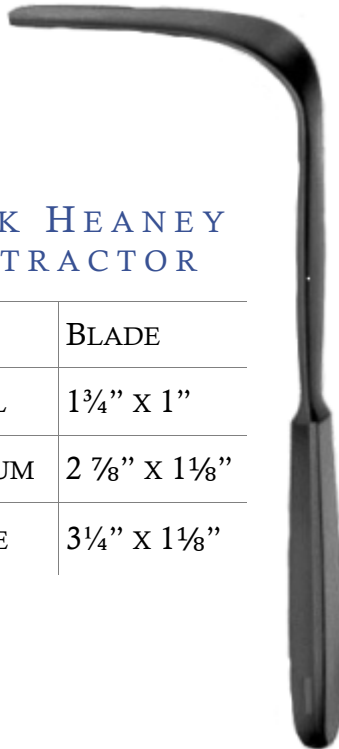

LASER BLACK HEANEY-SIMON VAGINAL RETRACTOR

ITEM NO.	BLADE
32-23-50-E	4 1/2" X 1"

10 1/2" OVERALL LENGTH



LASER BLACK RIBBON MALLEABLE RETRACTOR

ITEM NO.	BLADE
15-59-06-E	1/4" X 7"
15-59-10-E	1/2" X 7"
15-59-20-E	3/4" X 13"
15-59-25-E	1" X 13"

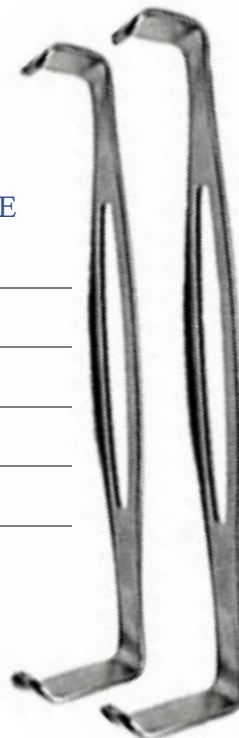

LASER BLACK US ARMY-NAVY RETRACTOR—SET OF 2

ITEM NO.	BLADE
15-39-00-E	SET OF 2
(A) OUTER BLADE	1" X 5/8" / 2" X 5/8"
8 1/2" OVERALL LENGTH	
(B) INNER BLADE	3/4" X 5/8" / 1 5/8" X 5/8"
8 1/4" OVERALL LENGTH	

AUTOCLAVABLE MEDICAL GRADE STAINLESS STEEL AND LASER BLACK COATING



TO ORDER CALL: (224) 353-6446



LASER BLACK INSTRUMENTS



MADE IN THE USA

LASER BLACK DEAVER RETRACTOR



19MM

ITEM NO.	BLADE
15-35-01-E	3/4" x 7"

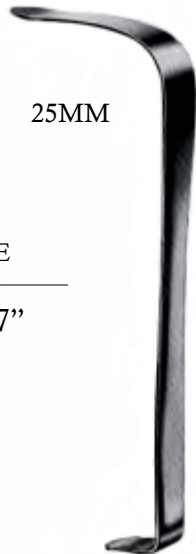

25MM

ITEM NO.	BLADE
15-35-03-E	1" x 9"



25MM

ITEM NO.	BLADE
15-35-10-E	1" x 12"

LASER BLACK RICHARDSON RETRACTOR



ITEM NO.	BLADE
15-26-01-E	1" x 3/4" - 9/4"



ITEM NO.	BLADE
15-26-02-E	1 1/4" x 1 1/8" - 9/4"



ITEM NO.	BLADE
15-26-03-E	1 1/2" x 1 1/2" - 10"
15-26-04-E	2 1/2" x 1 5/8" - 10"



LASER BLACK RICHARDSON EASTMAN RETRACTOR—SET OF 2



ITEM NO.	BLADE
32-25-00-E	SET OF 2 (A+B)
(A) 32-25-01-I SMALL	1 1/8" x 3/4" / 1 1/2" x 1 1/8"
10" OVERALL LENGTH	
(B) 32-25-02-I LARGE	1 3/4" x 1 1/2" / 2 1/2" x 1 5/8"

10 1/4" OVERALL LENGTH

AUTOCLAVABLE MEDICAL GRADE STAINLESS STEEL AND LASER BLACK COATING



WE DESIGN, MANUFACTURE & SELL THE TOOLS THE SURGEONS USE



LASER BLACK INSTRUMENTS



MADE IN THE USA

LASER BLACK LATERAL WALL VAGINAL RETRACTOR

THE ELMED LATERAL WALL VAGINAL RETRACTOR RETRACTS THE SIDE WALLS OF THE VAGINAL VAULT OFFERING INCREASED EXPOSURE TO THE CERVIX. THIS RETRACTOR IS DESIGNED AND SHAPED TO FIT INSIDE A STANDARD SPECULUM



RATCHET HANDLE—OPEN SHANKS—10½” OVERALL LENGTH

ITEM No.	BLADE SIZE	OVERALL LENGTH
32-16-02-E	2½” x 1”	10½”
32-16-03-E	3½” x 1”	10½”
32-16-04-E	4½” x 1”	10½”



SPRING RATCHET HANDLE—CLOSED SHANKS—11” OVERALL LENGTH

ITEM No.	BLADE SIZE	OVERALL
32-16-12-E	2½” x 1”	11”
32-16-13-E	3½” x 1”	11”

AUTOCLAVABLE MEDICAL GRADE STAINLESS STEEL AND LASER BLACK COATING



TO ORDER CALL: (224) 353-6446



LASER BLACK INSTRUMENTS



MADE IN THE USA

LASER BLACK TRU-VIEW™ LATERAL WALL RETRACTOR

THE ELMED TRU-VIEW™ LATERAL WALL RETRACTOR FEATURES LONGER, TAPERED BLADES FOR OPTIMAL CERVICAL EXPOSURE, ACCESS AND PATIENT COMFORT. UNIQUE ARM DESIGN FOR MORE STRENGTH AND SUPPORT, FOR USE WITH THE VU-MORE™ GRAVES & PEDERSON SPECULUM (S—XLARGE).



RATCHET HANDLE—TAPERED BLADES—12" OVERALL

ITEM NO.	BLADE SIZE	OVERALL LENGTH
32-16-24-E	4½" X 1¼"	12"

AUTOCLAVABLE MEDICAL GRADE STAINLESS STEEL AND LASER BLACK COATING



WE DESIGN, MANUFACTURE & SELL THE TOOLS THE SURGEONS USE



LASER BLACK GRAVES VAGINAL SPECULUMS—CLOSED SIDE



STYLE A—STANDARD

ITEM NO.	SIZE	BLADE
32-10-01-E	SMALL	3 ³ / ₈ " X 1"
32-10-02-E	MEDIUM	4" X 1 ³ / ₈ "
32-10-03-E	LARGE	4 ³ / ₄ " X 1 ¹ / ₂ "
32-10-04-E	X-LARGE	5 ¹ / ₂ " X 1 ¹ / ₂ "
32-10-05-E	XX-LARGE	7" X 1 ¹ / ₂ "

STYLE B—WITH PERMANENT SMOKE EVACUATION TUBE

ITEM NO.	SIZE	BLADE
32-10-01-EV	SMALL	3 ³ / ₈ " X 1"
32-10-02-EV	MEDIUM	4" X 1 ³ / ₈ "
32-10-03-EV	LARGE	4 ³ / ₄ " X 1 ¹ / ₂ "
32-10-04-EV	X-LARGE	5 ¹ / ₂ " X 1 ¹ / ₂ "
32-10-05-EV	XX-LARGE	7" X 1 ¹ / ₂ "

STYLE C—WITH SLOTTED SMOKE TUBE FOR DISPOSABLE

ITEM NO.	SIZE	BLADE
32-10-01-EM	SMALL	3 ³ / ₈ " X 1"
32-10-02-EM	MEDIUM	4" X 1 ³ / ₈ "
32-10-03-EM	LARGE	4 ³ / ₄ " X 1 ¹ / ₂ "
32-10-04-EM	X-LARGE	5 ¹ / ₂ " X 1 ¹ / ₂ "
32-10-05-EM	XX-LARGE	7" X 1 ¹ / ₂ "



**OPTIONAL FIBER-OPTIC LIGHT CARRIER & MOUNTING CLIP—SEE PAGE 75

AUTOCLAVABLE MEDICAL GRADE STAINLESS STEEL AND BLUE NYLON INSULATION



WE DESIGN, MANUFACTURE & SELL THE TOOLS THE SURGEONS USE



LASER BLACK INSTRUMENTS



MADE IN THE USA



LASER BLACK PEDERSON VAGINAL SPECULUMS—CLOSED SIDE

STYLE A—STANDARD

ITEM NO.	SIZE	BLADE
32-12-00-E	X-SMALL	2¾" X ½"
32-12-01-E	SMALL	3" X ½"
32-12-02-E	MEDIUM	4" X ⅞"
32-12-03-E	LARGE	4¾" X 1"
32-12-04-E	X-LARGE	6" X 1"
32-12-05-E	XX-LARGE	7" X 1"



STYLE B—WITH PERMANENT SMOKE EVACUATION TUBE

ITEM NO.	SIZE	BLADE
32-10-00-EV	X-SMALL	2¾" X ½"
32-10-01-EV	SMALL	3" X ½"
32-10-02-EV	MEDIUM	4" X ⅞"
32-10-03-EV	LARGE	4¾" X 1"
32-10-04-EV	X-LARGE	6" X 1"
32-10-05-EV	XX-LARGE	7" X 1"



STYLE C—WITH SLOTTED SMOKE TUBE FOR DISPOSABLE EVACUATION TUBE

ITEM NO.	SIZE	BLADE
32-10-00-EM	X-SMALL	2¾" X ½"
32-10-01-EM	SMALL	3" X ½"
32-10-02-EM	MEDIUM	4" X ⅞"
32-10-03-EM	LARGE	4¾" X 1"
32-10-04-EM	X-LARGE	6" X 1"
32-10-05-EM	XX-LARGE	7" X 1"

AUTOCLAVABLE MEDICAL GRADE STAINLESS STEEL AND LASER BLACK COATING



TO ORDER CALL: (224) 353-6446



LASER BLACK INSTRUMENTS



MADE IN THE USA

LASER BLACK WEISMAN GRAVES VAGINAL SPECULUM



STYLE A—STANDARD—ONE SIDE OPEN—90° HANDLE

RIGHT SIDE OPEN			LEFT SIDE OPEN		
ITEM NO.	SIZE	BLADE	ITEM NO.	SIZE	BLADE
32-10-11-E	SMALL	3 ³ / ₈ " X 1"	32-11-11-E	SMALL	3 ³ / ₈ " X 1"
32-10-12-E	MEDIUM	4" X 1 ³ / ₈ "	32-11-12-E	MEDIUM	4" X 1 ³ / ₈ "
32-10-13-E	LARGE	4 ³ / ₄ " X 1 ¹ / ₂ "	32-11-13-E	LARGE	4 ³ / ₄ " X 1 ¹ / ₂ "
32-10-14-E	X-LARGE	6" X 1 ¹ / ₂ "	32-11-14-E	X-LARGE	6" X 1 ¹ / ₂ "

STYLE B—WITH PERMANENT SMOKE EVACUATION TUBE—ONE SIDE OPEN—90° HANDLE



RIGHT SIDE OPEN			LEFT SIDE OPEN		
ITEM NO.	SIZE	BLADE	ITEM NO.	SIZE	BLADE
32-10-11-EV	SMALL	3 ³ / ₈ " X 1"	32-11-11-EV	SMALL	3 ³ / ₈ " X 1"
32-10-12-EV	MEDIUM	4" X 1 ³ / ₈ "	32-11-12-EV	MEDIUM	4" X 1 ³ / ₈ "
32-10-13-EV	LARGE	4 ³ / ₄ " X 1 ¹ / ₂ "	32-11-13-EV	LARGE	4 ³ / ₄ " X 1 ¹ / ₂ "
32-10-14-EV	X-LARGE	6" X 1 ¹ / ₂ "	32-11-14-EV	X-LARGE	6" X 1 ¹ / ₂ "

STYLE C—WITH SLOTTED SMOKE TUBE FOR DISPOSABLE EVACUATION TUBE—ONE SIDE OPEN—90° HANDLE



RIGHT SIDE OPEN			LEFT SIDE OPEN		
ITEM NO.	SIZE	BLADE	ITEM NO.	SIZE	BLADE
32-10-11-EM	SMALL	3 ³ / ₈ " X 1"	32-11-11-EM	SMALL	3 ³ / ₈ " X 1"
32-10-12-EM	MEDIUM	4" X 1 ³ / ₈ "	32-11-12-EM	MEDIUM	4" X 1 ³ / ₈ "
32-10-13-EM	LARGE	4 ³ / ₄ " X 1 ¹ / ₂ "	32-11-13-EM	LARGE	4 ³ / ₄ " X 1 ¹ / ₂ "
32-10-14-EM	X-LARGE	6" X 1 ¹ / ₂ "	32-11-14-EM	X-LARGE	6" X 1 ¹ / ₂ "

AUTOCLAVABLE MEDICAL GRADE STAINLESS STEEL AND LASER BLACK COATING



WE DESIGN, MANUFACTURE & SELL THE TOOLS THE SURGEONS USE



LASER BLACK INSTRUMENTS



MADE IN THE USA



LASER BLACK WEISMAN PEDERSON VAGINAL

STYLE A—STANDARD—ONE SIDE OPEN - 90° HANDLE

RIGHT SIDE OPEN			LEFT SIDE OPEN		
ITEM NO.	SIZE	BLADE	ITEM NO.	SIZE	BLADE
32-12-11-E	SMALL	3" X ½"	32-13-11-E	SMALL	3" X ½"
32-12-12-E	MEDIUM	4" X ⅞"	32-13-12-E	MEDIUM	4" X ⅞"
32-12-13-E	LARGE	4¾" X 1"	32-13-13-E	LARGE	4¾" X 1"
32-12-14-E	X-LARGE	6" X 1"	32-13-14-E	X-LARGE	6" X 1"

STYLE B—WITH PERMANENT SMOKE EVACUATION TUBE—ONE SIDE OPEN—90° HANDLE



RIGHT SIDE OPEN			LEFT SIDE OPEN		
ITEM NO.	SIZE	BLADE	ITEM NO.	SIZE	BLADE
32-12-11-EV	SMALL	3" X ½"	32-13-11-EV	SMALL	3" X ½"
32-12-12-EV	MEDIUM	4" X ⅞"	32-13-12-EV	MEDIUM	4" X ⅞"
32-12-13-EV	LARGE	4¾" X 1"	32-13-13-EV	LARGE	4¾" X 1"
32-12-14-EV	X-LARGE	6" X 1"	32-13-14-EV	X-LARGE	6" X 1"

STYLE C—WITH SLOTTED SMOKE TUBE FOR DISPOSABLE EVACUATION TUBE—ONE SIDE OPEN—90° HANDLE



RIGHT SIDE OPEN			LEFT SIDE OPEN		
ITEM NO.	SIZE	BLADE	ITEM NO.	SIZE	BLADE
32-12-11-EM	SMALL	3" X ½"	32-13-11-EM	SMALL	3" X ½"
32-12-12-EM	MEDIUM	4" X ⅞"	32-13-12-EM	MEDIUM	4" X ⅞"
32-12-13-EM	LARGE	4¾" X 1"	32-13-13-EM	LARGE	4¾" X 1"
32-12-14-EM	X-LARGE	6" X 1"	32-13-14-EM	X-LARGE	6" X 1"

AUTOCLAVABLE MEDICAL GRADE STAINLESS STEEL AND LASER BLACK COATING



TO ORDER CALL: (224) 353-6446



LASER BLACK INSTRUMENTS



MADE IN THE USA



LASER BLACK WEISMAN GRAVES VAGINAL SPECULUM

STYLE A—STANDARD—ONE SIDE OPEN—45° HANDLE

RIGHT SIDE OPEN			LEFT SIDE OPEN		
ITEM NO.	SIZE	BLADE	ITEM NO.	SIZE	BLADE
32-10-11A-E	SMALL	3 ³ / ₈ " X 1"	32-11-11A-E	SMALL	3 ³ / ₈ " X 1"
32-10-12A-E	MEDIUM	4" X 1 ³ / ₈ "	32-11-12A-E	MEDIUM	4" X 1 ³ / ₈ "
32-10-13A-E	LARGE	4 ³ / ₄ " X 1 ¹ / ₂ "	32-11-13A-E	LARGE	4 ³ / ₄ " X 1 ¹ / ₂ "
32-10-14A-E	X-LARGE	6" X 1 ¹ / ₂ "	32-11-14A-E	X-LARGE	6" X 1 ¹ / ₂ "

STYLE B—WITH PERMANENT SMOKE EVACUATION TUBE—ONE SIDE OPEN—45° HANDLE



RIGHT SIDE OPEN			LEFT SIDE OPEN		
ITEM NO.	SIZE	BLADE	ITEM NO.	SIZE	BLADE
32-10-11A-EV	SMALL	3 ³ / ₈ " X 1"	32-11-11A-EV	SMALL	3 ³ / ₈ " X 1"
32-10-12A-EV	MEDIUM	4" X 1 ³ / ₈ "	32-11-12A-EV	MEDIUM	4" X 1 ³ / ₈ "
32-10-13A-EV	LARGE	4 ³ / ₄ " X 1 ¹ / ₂ "	32-11-13A-EV	LARGE	4 ³ / ₄ " X 1 ¹ / ₂ "
32-10-14A-EV	X-LARGE	6" X 1 ¹ / ₂ "	32-11-14A-EV	X-LARGE	6" X 1 ¹ / ₂ "

STYLE C—WITH SLOTTED SMOKE TUBE FOR DISPOSABLE EVACUATION TUBE—ONE SIDE OPEN—45° HANDLE



RIGHT SIDE OPEN			LEFT SIDE OPEN		
ITEM NO.	SIZE	BLADE	ITEM NO.	SIZE	BLADE
32-10-11A-EM	SMALL	3 ³ / ₈ " X 1"	32-11-11A-EM	SMALL	3 ³ / ₈ " X 1"
32-10-12A-EM	MEDIUM	4" X 1 ³ / ₈ "	32-11-12A-EM	MEDIUM	4" X 1 ³ / ₈ "
32-10-13A-EM	LARGE	4 ³ / ₄ " X 1 ¹ / ₂ "	32-11-13A-EM	LARGE	4 ³ / ₄ " X 1 ¹ / ₂ "
32-10-14A-EM	X-LARGE	6" X 1 ¹ / ₂ "	32-11-14A-EM	X-LARGE	6" X 1 ¹ / ₂ "

AUTOCLAVABLE MEDICAL GRADE STAINLESS STEEL AND LASER BLACK COATING



WE DESIGN, MANUFACTURE & SELL THE TOOLS THE SURGEONS USE



LASER BLACK INSTRUMENTS



MADE IN THE USA



LASER BLACK WEISMAN PEDERSON VAGINAL SPECULUM

STYLE A—STANDARD—ONE SIDE OPEN—45° HANDLE

RIGHT SIDE OPEN			LEFT SIDE OPEN		
ITEM NO.	SIZE	BLADE	ITEM NO.	SIZE	BLADE
32-12-11A-E	SMALL	3" x ½"	32-11-11A-E	SMALL	3" x ½"
32-12-12A-E	MEDIUM	4" x ⅞"	32-11-12A-E	MEDIUM	4" x ⅞"
32-12-13A-E	LARGE	4¾" x 1"	32-11-13A-E	LARGE	4¾" x 1"
32-12-14A-E	X-LARGE	6" x 1"	32-11-14A-E	X-LARGE	6" x 1"

STYLE B—WITH PERMANENT SMOKE EVACUATION TUBE—ONE SIDE OPEN—45° HANDLE



RIGHT SIDE OPEN			LEFT SIDE OPEN		
ITEM NO.	SIZE	BLADE	ITEM NO.	SIZE	BLADE
32-12-11A-EV	SMALL	3" x ½"	32-11-11A-EV	SMALL	3" x ½"
32-12-12A-EV	MEDIUM	4" x ⅞"	32-11-12A-EV	MEDIUM	4" x ⅞"
32-12-13A-EV	LARGE	4¾" x 1"	32-11-13A-EV	LARGE	4¾" x 1"
32-12-14A-EV	X-LARGE	6" x 1"	32-11-14A-EV	X-LARGE	6" x 1"

STYLE C—WITH SLOTTED SMOKE TUBE FOR DISPOSABLE EVACUATION TUBE—ONE SIDE OPEN—45° HANDLE



RIGHT SIDE OPEN			LEFT SIDE OPEN		
ITEM NO.	SIZE	BLADE	ITEM NO.	SIZE	BLADE
32-12-11A-EM	SMALL	3" x ½"	32-11-11A-EM	SMALL	3" x ½"
32-12-12A-EM	MEDIUM	4" x ⅞"	32-11-12A-EM	MEDIUM	4" x ⅞"
32-12-13A-EM	LARGE	4¾" x 1"	32-11-13A-EM	LARGE	4¾" x 1"
32-12-14A-EM	X-LARGE	6" x 1"	32-11-14A-EM	X-LARGE	6" x 1"

AUTOCLAVABLE MEDICAL GRADE STAINLESS STEEL AND LASER BLACK COATING



TO ORDER CALL: (224) 353-6446



LASER BLACK INSTRUMENTS



MADE IN THE USA

LASER BLACK GRAVES VU-MORE™ VAGINAL SPECULUM WITH 1 5/8" WIDE YOKE**

**ALLOWING ENHANCED VIEWING, MANEUVERING AND INSTRUMENT ACCESS



STYLE A—STANDARD

ITEM NO.	SIZE	BLADE
32-19-400-E	SMALL	3 1/2" X 1"
32-19-401-E	MEDIUM	4" X 1 1/2"
32-19-402-E	LARGE	4 3/4" X 1 1/2"
32-19-403-E	X-LARGE	6" X 1 1/2"

STYLE B—WITH PERMANENT SMOKE EVACUATION TUBE



ITEM NO.	SIZE	BLADE
32-19-400-EV	SMALL	3 1/2" X 1"
32-19-401-EV	MEDIUM	4" X 1 1/2"
32-19-402-EV	LARGE	4 3/4" X 1 1/2"
32-19-403-EV	X-LARGE	6" X 1 1/2"

STYLE C—WITH SLOTTED SMOKE TUBE FOR DISPOSABLE EVACUATION TUBE



ITEM NO	SIZE	BLADE
32-19-400-EM	SMALL	3 1/2" X 1"
32-19-401-EM	MEDIUM	4" X 1 1/2"
32-19-402-EM	LARGE	4 3/4" X 1 1/2"
32-19-403-EM	X-LARGE	6" X 1 1/2"

AUTOCLAVABLE MEDICAL GRADE STAINLESS STEEL AND BLACK LASER COATING



WE DESIGN, MANUFACTURE & SELL THE TOOLS THE SURGEONS USE



LASER BLACK INSTRUMENTS



MADE IN THE USA



LASER BLACK PEDERSON VU-MORE™ VAGINAL SPECULUM WITH 1 5/8" WIDE YOKE**

**ALLOWING ENHANCED VIEWING, MANEUVERING AND INSTRUMENT ACCESS

STYLE A—STANDARD

ITEM NO.	SIZE	BLADE
32-19-410-E	SMALL	3" x 1/2"
32-19-411-E	MEDIUM	4" x 1 1/2"
32-19-412-E	LARGE	4 3/4" x 1 1/2"
32-19-413-E	X-LARGE	6" x 1 1/2"

STYLE B—WITH PERMANENT SMOKE EVACUATION TUBE



ITEM NO.	SIZE	BLADE
32-19-410-EV	SMALL	3" x 1/2"
32-19-411-EV	MEDIUM	4" x 1 1/2"
32-19-412-EV	LARGE	4 3/4" x 1 1/2"
32-19-413-EV	X-LARGE	6" x 1 1/2"

STYLE C—WITH SLOTTED SMOKE TUBE FOR DISPOSABLE EVACUATION TUBE



ITEM NO.	SIZE	BLADE
32-19-410-EM	SMALL	3" x 1/2"
32-19-411-EM	MEDIUM	4" x 1 1/2"
32-19-412-EM	LARGE	4 3/4" x 1 1/2"
32-19-413-EM	X-LARGE	6" x 1 1/2"

AUTOCLAVABLE MEDICAL GRADE STAINLESS STEEL AND LASER BLACK COATING



TO ORDER CALL: (224) 353-6446



LASER BLACK INSTRUMENTS



MADE IN THE USA



LASER BLACK PEDERSON WIDE VIEW VU-MAX VAGINAL SPECULUM WITH 2 3/4" SQUARE YOKE**

**ALLOWING ENHANCED VIEWING, MANEUVERING AND INSTRUMENT ACCESS

STYLE A—STANDARD

ITEM NO.	SIZE	BLADE
32-20-413-E	MEDIUM	4" x 1 1/2"
32-20-414-E	LARGE	4 1/2" x 1 1/2"



STYLE B—WITH PERMANENT SMOKE EVACUATION

ITEM NO.	SIZE	BLADE
32-20-413-EV	MEDIUM	4" x 1 1/2"
32-20-414-EV	LARGE	4 1/2" x 1 1/2"



STYLE C—WITH SLOTTED SMOKE TUBE FOR DISPOSABLE EVACUATION TUBE

ITEM NO.	SIZE	BLADE
32-20-413-EM	MEDIUM	4" x 1 1/2"
32-20-414-EM	LARGE	4 1/2" x 1 1/2"

AUTOCLAVABLE MEDICAL GRADE STAINLESS STEEL AND LASER BLACK COATING



TO ORDER CALL: (224) 353-6446



LASER BLACK INSTRUMENTS



MADE IN THE USA



LASER BLACK GRAVES WIDE VIEW VU-MAX VAGINAL SPECULUM WITH 2 3/4" SQUARE YOKE**

**ALLOWING ENHANCED VIEWING, MANEUVERING AND INSTRUMENT ACCESS

STYLE A—STANDARD

ITEM NO.	SIZE	BLADE
32-20-403-E	MEDIUM	4" X 1 1/2"
32-20-404-E	LARGE	4 3/4" X 1 1/2"



STYLE B—WITH PERMANENT SMOKE EVACUATION TUBE

ITEM NO.	SIZE	BLADE
32-20-403-EV	MEDIUM	4" X 1 1/2"
32-20-404-EV	LARGE	4 3/4" X 1 1/2"



STYLE C—WITH SLOTTED SMOKE TUBE FOR DISPOSABLE EVACUATION TUBE

ITEM NO.	SIZE	BLADE
32-20-403-EM	MEDIUM	4" X 1 1/2"
32-20-404-EM	LARGE	4 3/4" X 1 1/2"

AUTOCLAVABLE MEDICAL GRADE STAINLESS STEEL AND LASER BLACK COATING



WE DESIGN, MANUFACTURE & SELL THE TOOLS THE SURGEONS USE



LASER BLACK INSTRUMENTS



MADE IN THE USA



LASER BLACK MAX VIEW 4 BLADED VAGINAL

STYLE C—WITH SLOTTED SMOKE TUBE FOR DISPOSABLE

ITEM NO.	SIZE
32-15-02-EM	MEDIUM



LASER BLACK COLLIN VAGINAL SPECULUM

STYLE A—STANDARD

ITEM NO.	SIZE	BLADE
32-17-416-E	SMALL	3¾" x 1¼"
32-17-418-E	MEDIUM	4" x 1⅜"
32-17-420-E	LARGE	4½" x 1⅝"



STYLE B—WITH PERMANENT SMOKE EVACUATION TUBE

ITEM NO.	SIZE	BLADE
32-17-416-EV	SMALL	3¾" x 1¼"
32-17-418-EV	MEDIUM	4" x 1⅜"
32-17-420-EV	LARGE	4½" x 1⅝"



STYLE C—WITH SLOTTED SMOKE TUBE FOR DISPOSABLE EVACUATION

ITEM NO.	SIZE	BLADE
32-17-416-EM	SMALL	3¾" x 1¼"
32-17-418-EM	MEDIUM	4" x 1⅜"
32-17-420-EM	LARGE	4½" x 1⅝"

Autoclavable Medical Grade Stainless Steel and Blue Nylon Insulation





LASER BLACK INSTRUMENTS



MADE IN THE USA



LASER BLACK CUSCO VAGINAL SPECULUMS WITH PERMANENT SMOKE EVACUATION TUBE

ITEM NO.	SIZE	BLADE
32-16-01-EV	SMALL	3" x 1¼"
32-16-02-EV	MEDIUM	3½" x 1½"
32-16-03-EV	LARGE	3¾" x 1¾"

LASER BLACK KOGAN ENDOCERVICAL SPECULUM

TIP 7 X 25MM TIP 3 X 25MM



WITH GAUGE/SCREW
SPRING HANDLE

32-24-34-E	TIP 7 X 25MM
32-24-35-E	TIP 3 X 25MM



WITH SPRING HANDLE

32-25-44-E	TIP 7 X 25MM
32-25-45-E	TIP 3 X 25MM



W RATCHET HANDLE

32-24-24-E	TIP 7 X 25MM
32-24-25-E	TIP 3 X 25MM

AUTOCLAVABLE MEDICAL GRADE STAINLESS STEEL AND LASER BLACK COATING



TO ORDER CALL: (224) 353-6446



LASER BLACK INSTRUMENTS



MADE IN THE USA



LASER BLACK AUVARD VAGINAL SPECULUM

FEATURING MULTIPLE WEIGHTS AND BLADE SIZES FOR DOWNWARD PULLING FOR MAXIMUM VIEWING

STYLE A—INSULATED STANDARD

ITEM NO.	BLADE & ANGLE	WEIGHT	OVERALL LENGTH
32-22-601-E	3¼" X 1½" - 75°	2 LBS.	9"
32-22-603-E	3½" X 1½" - 75°	2½ LBS.	9"
32-22-605-E	4" X 1¾" - 75°	3 LBS.	9"
32-22-607-E	4" X 1¾" - 45°	2½ LBS.	9"

STYLE B—INSULATED WITH PERMANENT SMOKE EVACUATION TUBE

ITEM NO.	BLADE & ANGLE	WEIGHT	OVERALL LENGTH
32-22-601-EV	3¼" X 1½" - 75°	2 LBS.	9"
32-22-603-EV	3½" X 1½" - 75°	2½ LBS.	9"
32-22-605-EV	4" X 1¾" - 75°	3 LBS.	9"
32-22-607-EV	4" X 1¾" - 45°	2½ LBS.	9"

STYLE C—WITH SLOTTED SMOKE TUBE FOR DISPOSAL EVACUATION TUBE

ITEM NO.	BLADE & ANGLE	WEIGHT	OVERALL LENGTH
32-22-601-EM	3¼" X 1½" - 75°	2 LBS.	9"
32-22-603-EM	3½" X 1½" - 75°	2½ LBS.	9"
32-22-605-EM	4" X 1¾" - 75°	3 LBS.	9"
32-22-607-EM	4" X 1¾" - 45°	2½ LBS.	9"

AUTOCLAVABLE MEDICAL GRADE STAINLESS STEEL AND LASER BLACK COATING



WE DESIGN, MANUFACTURE & SELL THE TOOLS THE SURGEONS USE



LASER BLACK INSTRUMENTS



MADE IN THE USA



LASER BLACK STEINER-AUVARD VAGINAL SPECULUM

FOR DEEP VAGINAL SURGERY FEATURING 90° SLIGHTLY CURVED BLADE

STYLE A—INSULATED STANDARD

ITEM NO.	BLADE & ANGLE	WEIGHT	OVERALL
32-22-652-E	5½" x 1¼" - 90°	2½ LBS.	9"



STYLE B—INSULATED WITH PERMANENT SMOKE EVACUATION TUBE

ITEM NO.	BLADE & ANGLE	WEIGHT	OVERALL LENGTH
32-22-652-EV	5½" x 1¼" - 90°	2½ LBS.	9"



STYLE C—WITH SLOTTED SMOKE TUBE FOR DISPOSABLE EVACUATION TUBE

ITEM NO.	BLADE & ANGLE	WEIGHT	OVERALL LENGTH
32-22-652-EM	5½" x 1¼" - 90°	2½ LBS.	9"

AUTOCLAVABLE MEDICAL GRADE STAINLESS STEEL AND LASER BLACK COATING



TO ORDER CALL: (224) 353-6446



LASER BLACK INSTRUMENTS



MADE IN THE USA



LASER BLACK COMPACT WEIGHTED “E” VAGINAL SPECULUM

COMPACT WITH COMFORT GRIP HANDLE AND CONCAVE BLADE WITH RIGHT ANGLE TIP FOR MAXIMUM PATIENT COMFORT

STYLE A—INSULATED STANDARD

ITEM NO.	BLADE	WEIGHT	OVERALL LENGTH
32-23-15-E	3¾” X 1½”	1½ LBS.	10”
32-23-16-E	3¾” X 1½”	2½” LBS.	11”
32-23-17-E	3¾” X 1½”	3 LBS.	12”

STYLE B—INSULATED WITH PERMANENT SMOKE EVACUATION TUBE



ITEM NO.	BLADE	WEIGHT	OVERALL LENGTH
32-23-15-EV	3¾” X 1½”	1½ LBS.	10”
32-23-16-EV	3¾” X 1½”	2½ LBS.	11”
32-23-17-EV	3¾” X 1½”	3 LBS.	12”

STYLE C—WITH SLOTTED SOKE TUBE FOR DISPOSABLE EVACUATION TUBE



ITEM NO.	BLADE	WEIGHT	OVERALL LENGTH
32-23-15-EM	3¾” X 1½”	1½ LBS.	10”
32-23-16-EM	3¾” X 1½”	2½ LBS.	11”
32-23-17-EM	3¾” X 1½”	3 LBS.	12”

AUTOCLAVABLE MEDICAL GRADE STAINLESS STEEL AND LASER BLACK COATING



WE DESIGN, MANUFACTURE & SELL THE TOOLS THE SURGEONS USE



LASER BLACK INSTRUMENTS



MADE IN THE USA



LASER BLACK COMPACT HEANEY STYLE VAGINAL SPECULUM

COMPACT WITH COMFORT GRIP HANDLE AND FLAT ANGLED BLADE FOR MAXIMUM PATIENT COMFORT

STYLE A—INSULATED STANDARD

ITEM NO.	BLADE & ANGLE	WEIGHT	OVERALL LENGTH
32-23-34-E	4" X 1" - 45°	3 LBS.	13½"



STYLE B—INSULATED WITH PERMANENT SMOKE EVACUATION TUBE

ITEM NO.	BLADE & ANGLE	WEIGHT	OVERALL LENGTH
32-23-34-EV	4" X 1" - 45°	3 LBS.	13½"



STYLE C—WITH SLOTTED SMOKE TUBE FOR DISPOSAL EVACUATION TUBE

ITEM NO.	BLADE & ANGLE	WEIGHT	OVERALL LENGTH
32-23-34-EM	4" X 1" - 45°	3 LBS.	13½"

AUTOCLAVABLE MEDICAL GRADE STAINLESS STEEL AND LASER BLACK COATING



TO ORDER CALL: (224) 353-6446



LASER BLACK INSTRUMENTS



MADE IN THE USA

ELMED LASER BLACK STAINLESS STEEL VAGINAL DILATOR

CUSTOM STAINLESS LASER BLACK VAGINAL DILATORS WITH SMOOTH CURVED TIP FOR COMFORTABLE INSERTION AND BASE WITH GROOVES ON HANDLE FOR ANTI-SLIP CONTROL FOR USE IN CONJUNCTION WITH LASER APPLICATION.

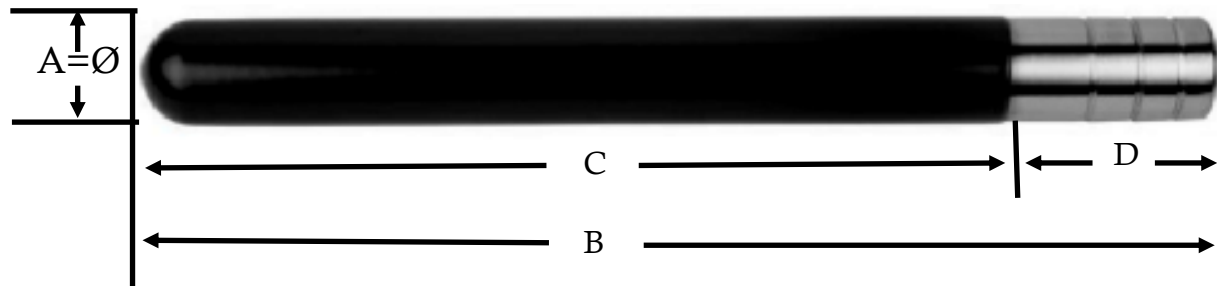

- (A) DIAMETER OF INSTRUMENT PER ITEM NO.
 (B) OVERALL LENGTH PER ITEM NO.
 (C) INSULATED-NON CONDUCTIVE TIP + SHAFT—ALL 9³/₄" (24.8CM) LENGTH
 (D) UNINSULATED GROOVED HANDLE—ALL 2" (5.1CM) LENGTH

ITEM NO.	DESCRIPTION
32-5001-E	(A)- ³ / ₄ " (1.9 CM) DIA. X (B)- 11 ³ / ₄ " (30CM) OVERALL LENGTH. LASER BLACK COATED STAINLESS STEEL VAGINAL DILATOR
32-5002-E	(A)-1" (2.5 CM) DIA. X (B)- 11 ³ / ₄ " (30CM) OVERALL LENGTH. LASER BLACK COATED STAINLESS STEEL VAGINAL DILATOR
32-5003-E	(A)-1 ¹ / ₄ " (3.18 CM) DIA. X (B)- 11 ³ / ₄ " (30CM) OVERALL LENGTH. LASER BLACK COATED STAINLESS STEEL VAGINAL DILATOR
32-5004-E	(A)-1 ¹ / ₂ " (3.8 CM) DIA. X (B)- 11 ³ / ₄ " (30CM) OVERALL LENGTH. LASER BLACK COATED STAINLESS STEEL VAGINAL DILATOR
32-5005-E	(A)-1 ³ / ₄ " (4.45 CM) DIA. X (B)- 11 ³ / ₄ " (30CM) OVERALL LENGTH. LASER BLACK COATED STAINLESS STEEL VAGINAL DILATOR





LASER BLACK INSTRUMENTS



MADE IN THE USA



STYLE #1



STYLE #2



STYLE #3



STYLE #4



STYLE #5

LASER BLACK JOSEPH SKIN HOOKS POINTED TIP

STYLE NO.	ITEM NO./O.L.	ITEM NO./O.L.
1—PRONG	32-216-01-E/ 1¼"	32-219-01-E/ 9"
2—2MM/2 PRONG	32-216-02-E/ 6¼"	32-219-02-E/ 9"
3—5MM/2 PRONG	32-216-05-E/ 6¼"	32-219-05-E/ 9"
4—7MM/2 PRONG	32-216-07-E/ 6¼"	32-219-07-E/ 9"
5—10MM/2 PRONG	32-216-10-E/ 6¼"	32-219-10-E/ 9"



LASER BLACK GUTHRIE DOUBLE HOOKS SHARP, 5" OVERALL LENGTH

3MM—2 SMALL
PRONG



32-212-01-E

5MM—LARGE PRONG



32-212-02-E



LASER BLACK THREE PRONG HOOK

ITEM NO.	DESCRIPTION
32-803-26-E	10¼" OVERALL LENGTH

AUTOCLAVABLE MEDICAL GRADE STAINLESS STEEL AND LASER BLACK COATING



TO ORDER CALL: (224) 353-6446



LASER BLACK INSTRUMENTS







MADE IN THE USA

LASER BLACK IRIS HOOKS QUICK RELEASE

	STYLE #1
1MM DIA.	
	STYLE #2
3MM DIA.	
	STYLE#3
4MM DIA.	
	STYLE #4
6MM DIA.	

LASER BLACK EMMETT HOOKS

	STYLE #1
	STYLE #2
	STYLE#3
	STYLE #4
	STYLE #5

ITEM NO.	TIP SIZE	OVERALL LENGTH
32-509-01-E	1MM	9"
32-509-03-E	3MM	9"
32-509-04-E	4MM	9"
32-509-06-E	6MM	9"
32-512-01-E	1MM	12"
32-512-03-E	3MM	12"
32-512-04-E	4MM	12"
32-512-06-E	6MM	12"

ITEM NO.	STYLE	OVERALL LENGTH
32-958-01-E	1	9"
32-958-02-E	2	9"
32-958-03-E	3	9"
32-958-04-E	4	9"
32-958-05-E	5	9"

STANDARD INSULATION. COMPLETE INSULATION WITH 2MM TIP EXPOSED.

AUTOCLAVABLE MEDICAL GRADE STAINLESS STEEL AND LASER BLACK COATING



WE DESIGN, MANUFACTURE & SELL THE TOOLS THE SURGEONS USE





LASER BLACK INSTRUMENTS



MADE IN THE USA



LASER BLACK LEEP RULERS

LASER BLACK LEEP DEEP RULER		LASER BLACK LEEP WIDTH RULER	
			
ITEM NO.	DESCRIPTION	ITEM NO.	DESCRIPTION
32-600-24-E	240MM WORKING LENGTH	32-610-21-E	210MM WORKING LENGTH





SERVICE AND REPAIR



MADE IN THE USA

IN NEED OF INSTRUMENT REPAIRS? SEND THEM TO THE *ER!*

ELMED REPAIR

60 YEARS OF EXPERIENCE AND KNOWLEDGE IN DESIGNING, ENGINEERING, MANUFACTURING AND REPAIRING FOR THE MEDICAL COMMUNITY HAS GIVEN ELMED, INC. ONE OF THE BEST REPUTATIONS IN THE INDUSTRY. WE REPAIR WHAT OTHERS ARE UNABLE OR UNWILLING TO DO AND WE REPAIR ALL COMPETITIVE BRANDS. OUR WORK IS PERFORMED BY SKILLED TECHNICIANS, ALL OF WHICH HAVE BEEN WITH ELMED FOR THE PAST 10-30 YEARS.

COMPLETE IN-HOUSE MACHINE SHOP, POWDER COATING, LASER WELDING, & MARKING FINISHING, ELECTRONICS AND OPTICAL DEPARTMENTS

AREAS OF SPECIALTY

- LAPAROSCOPIC AND ENDOSCOPIC INSTRUMENTS
- ELECTROSURGICAL UNITS AND ACCESSORIES
- FIBER OPTIC LIGHT CABLES AND RETRACTORS
- RIGID ENDOSCOPES & FLEXIBLE SINUSCOPES
- STAINLESS STEEL HAND INSTRUMENTS
- LIGHT SOURCES AND HEADLIGHTS
- DEBRIDER UNITS, HAND PIECES AND BLADES
- SELF RETAINING RETRACTOR SYSTEMS

HOW TO PACKAGE AND SHIP INSTRUMENTS

- **IMPORTANT:** ELMED CANNOT ACCEPT INSTRUMENTS THAT HAVE NOT BEEN PROPERLY CLEANED, DISINFECTED OR STERILIZED.
- INCLUDE CUSTOMER NAME AND ALL CONTACT INFORMATION (NAME, ADDRESS, PHONE NO., FAX NO., EMAIL ADDRESS, ETC.)
- INCLUDE CUSTOMER P.O. (PURCHASE ORDER), IF USED
- INCLUDE REASON FOR RETURN - BRIEF DESCRIPTION OF REPAIR PROBLEM IF AVAILABLE
- WRAP INSTRUMENT FOR PROTECTION DURING TRANSPORT

PLEASE FILL OUT, DETACH, AND INCLUDE THE FORM BELOW WITH YOUR REPAIR:

FROM:	
FACILITY:	CONTACT PERSON:
ADDRESS:	
CITY, STATE, ZIP	
EMAIL:	PHONE NO.
PO. NO.	QTY.

INSTRUMENT DESCRIPTION:

(NOTE: PLEASE INCLUDE MODEL NO. AND SERIAL NO. IN INSTRUMENT DESCRIPTION FOR SCOPES)

FAST SERVICE: INCOMING REPAIRS COMING IN BY NEXT DAY AIR WILL BE COMPLETED WITHIN 24 HRS (WHEN PARTS ARE AVAILABLE)

SHIP TO: **ELMED** 35 N BRANDON DR., GLENDALE HEIGHTS, IL 60139