

# ELMED



SERVING THE MEDICAL PROFESSION SINCE 1955



## LAPAROSCOPIC SURGERY

**WE DESIGN, MANUFACTURE, & SELL THE TOOLS THE SURGEONS USE**

ELMED INC.  
35 N. BRANDON DR.  
GLENDALE HEIGHTS,  
IL 60139  
USA

WE SUBSCRIBE TO  
COST  
CONTAINMENT AND  
PROTECTION OF  
THE ENVIRONMENT



MADE IN THE USA

THEREFORE, WE  
MANUFACTURE  
REUSABLE  
PRODUCTS FOR A  
CLEANER WORLD

PH (224) 353-6446  
FAX (224) 653-8178  
EMAIL  
MEDICAL@ELMED.COM  
WWW.ELMED.COM

# TABLE OF CONTENTS

| <b>TROCARS, CANNULAS &amp; SCOPES</b>   | <b>PAGE</b> |
|---|-------------|
| ELMED EOS HD LAPAROSCOPES & TP11 TELESCOPE PRE-HEATER   | 2           |
| ELMED EOS HD OPERATING LAPAROSCOPES & REPLACEMENT PARTS FOR ELMED EOS HD OPERATING LAPAROSCOPES       | 3           |
| ELMED “LITE” THERMOPLASTIC TROCAR SLEEVES & TROCARS   | 4           |
| REPLACEMENT ACCESSORIES FOR “LITE” TROCAR SLEEVES   | 5           |
| ELMED LIGHTWEIGHT MAGNA-CLOSE TROCAR SLEEVES & TROCARS  | 6           |
| STAINLESS STEEL TROCAR SLEEVES W/ TRUMPET VALVE   | 7           |
| ELMED STAINLESS STEEL SAFETY TROCARS, SPRING LOADED, DILATION SETS-COMPLETE SLEEVE & PROBE & REDUCERS | 8           |
| ELMED HASSON CANNULA FOR OPEN LAPAROSCOPY, REPLACEMENT SEALING CAPS & HASSON “S-SHAPED” RETRACTORS    | 9           |
| LAPAROSCOPIC ADAPTERS   | 10          |
| <b>VALLEY SERIES-RIGID, ONE-PIECE LAPAROSCOPIC INSTRUMENTS</b>  | <b>PAGE</b> |
| INSULATED & CARBON FIBER HANDLES  | 12          |
| NON-INSULTED HANDLES  | 13          |
| 5MM GRASPERS & DISSECTORS   | 14-26       |
| 5MM SCISSORS & BIOPSY FORCEPS   | 27-29       |
| 10MM GRASPERS & DISSECTORS  | 30-32       |
| <b>BASIN SERIES-ROTATABLE, ONE-PIECE LAPAROSCOPIC INSTRUMENTS</b>                                     | <b>PAGE</b> |
| INSULATED & CARBON FIBER HANDLES  | 34          |
| NON-INSULTED HANDLES  | 35          |
| 5MM GRASPERS & DISSECTORS   | 36-48       |
| 5MM SCISSORS & BIOPSY FORCEPS   | 49-51       |
| 10MM GRASPERS & DISSECTORS  | 52-53       |
| 10MM SCISSORS & BIOPSY FORCEPS  | 54          |
| <b>SUMMIT SERIES-ROTATABLE, THREE-PIECE MODULAR LAPAROSCOPIC INSTRUMENTS</b>                          | <b>PAGE</b> |
| SUMMIT SERIES OUTER TUBES & ACCESSORIES   | 56          |
| INSULATED & CARBON FIBER HANDLES  | 57          |
| NON-INSULTED HANDLES  | 58          |
| 5MM GRASPERS & DISSECTORS   | 59-72       |
| 5MM SCISSORS & BIOPSY FORCEPS   | 73-75       |
| 10MM GRASPERS & DISSECTORS  | 76-78       |
| <b>SURE GRIP SERIES: RIGID, ROTATABLE &amp; MODULAR</b>   | <b>PAGE</b> |
| 5MM SLIDE-LOCK HANDLE GRASPERS  | 80-86       |
| <b>DISPOSABLE &amp; REPOSABLE SERIES</b>  | <b>PAGE</b> |
| REPOSABLE HANDLE & SHAFT W/ DISPOSABLE TIPS   | 88          |
| REPOSABLE HANDLE & SHAFT W/ REPOSABLE TIPS  | 89          |

| <b>TRADITIONAL SERIES</b>  | <b>PAGE</b> |
|--|-------------|
| 5MM TRADITIONAL LAPAROSCOPIC INSTRUMENTS   | 91-93       |
| 10MM TRADITIONAL LAPAROSCOPIC INSTRUMENTS  | 94          |
| <b>SUTURE &amp; LIGATURE INSTRUMENTS</b>   | <b>PAGE</b> |
| ELMED LAPAROSCOPIC 5MM CLIP APPLIERS   | 96          |
| ELMED LAPAROSCOPIC 10MM CLIP APPLIERS  | 97          |
| ELMED LAPAROSCOPIC 5MM NEEDLE HOLDERS  | 98-100      |
| ELMED MODULAR SCREW-APART LAPAROSCOPIC 5MM NEEDLE HOLDERS  | 101-105     |
| NEEDLE HOLDERS   | 106         |
| ELMED KNOT PUSHERS   | 107         |
| SUTURE PASSER & STAINLESS STEEL TROCAR GUIDE CONES   | 108         |
| <b>SPECIALTY LAP INSTRUMENTS</b>   | <b>PAGE</b> |
| HASSON 3-PRONG GRASPER & MYOMA SCREW   | 110         |
| CHOLANGIOGRAM CLAMP, ENDOSCOPIC MAGNETIC ROD, RETRACTABLE ENDOSCOPIC KNIFE   | 111         |
| ATRAUMATIC LONG JAW CHOLANGIOGRAM CLAMP  | 112         |
| SILASTIC RING APPLICATOR FOR TUBULAR STERILIZATION & COHEN CANNULA   | 113         |
| UTERINE MANIPULATOR  | 114         |
| UTERINE TENACULUM  | 115         |
| ASPIRATION NEEDLES, VERESS NEEDLES   | 116         |
| PALPITATION PROBES   | 116         |
| SPECIALTY CANNULAS   | 117-118     |
| <b>SELF-RETAINING RETRACTOR SYSTEMS &amp; MINIMAL INVASIVE RETRACTORS</b>  | <b>PAGE</b> |
| ELMED RETRACT ROBOT IN LAPAROSCOPIC SURGERY  | 120         |
| ELMED GOOSE NECK RETRACT ROBOT IN LAPAROSCOPIC SURGERY   | 121         |
| NATHANSON LIVER RETRACTORS   | 122-123     |
| NATHANSON LIVER RETRACTORS FOR ROBOTIC USE   | 124         |
| 90° ARTICULATING FLAT BLADE RETRACTORS   | 125         |
| LAP BANDING RETRACTORS W/ RATCHET HANDLE   | 126         |
| SNAKE RETRACTORS   | 127         |
| FAN, KITE RETRACTORS & MINIMALLY INVASIVE RETRACTORS/ELEVATORS   | 128         |
| <b>ELECTROSURGICAL UNITS FOR LAPAROSCOPY</b>   | <b>PAGE</b> |
| ESU 400 DIGITAL ELECTROSURGICAL UNIT –FOR LAPAROSCOPY & OTHER MINIMALLY INVASIVE PROCEDURES                                  | 130-131     |
| ELMED LAPAROSCOPIC LBC 50-P DIGITAL BIPOLAR GENERATOR W/ INTEGRATED AMMETER, VISUAL COAGULATION INDICATOR AUTOMATIC SHUT-OFF | 132         |
| ELMED ARFM BIPOLAR LAPAROSCOPIC COAGULATION MONITOR  | 133         |

| <b>BIPOLAR LAP INSTRUMENTS</b>   | <b>PAGE</b> |
|--|-------------|
| THE ORIGINAL KLEPPINGER BIPOLAR LAPAROSCOPIC FORCEPS   | 135         |
| ELMED KLEPPINGER TYPE III BIPOLAR LAPAROSCOPIC FORCEPS & REUSABLE REPLACEMENT TONGS                            | 136         |
| POWERGRIP BIPOLAR SCISSORS & FORCEPS   | 137         |
| 360° ROTATABLE ORBITARIS BIPOLAR SCISSORS & FORCEPS  | 138         |
| POWERGRIP 3.0MM BIPOLAR DISSECTOR & GRASPER  | 139         |
| CLASSIC BIPOLAR SCISSORS & FORCEPS   | 140         |
| ELMED BIPOLAR TRIPLE-FUNCTION FORCEPS & BIPOLAR COAGULATION PROBES   | 141         |
| 3MM & 5MM LAPAROSCOPIC BIPOLAR ELECTRODES  | 142         |
| REUSABLE CABLES FOR BIPOLAR INSTRUMENTS & GENERATORS   | 143         |
| <b>MONOPOLAR LAP INSTRUMENTS</b>   | <b>PAGE</b> |
| 5MM DIAMETER MONOPOLAR ELECTRODES  | 145         |
| 5MM DIAMETER MONOPOLAR ELECTRODES– W/ SUCTION/IRRIGATION PORT  | 146         |
| 5MM DIAMETER MONOPOLAR ELECTRODES– FOR USE W/ HAND-SWITCHING HANDLES   | 146         |
| ELMED RETRACTABLE NEEDLE ELECTRODES FOR PRECISE CUTTING & COAGULATION  | 147         |
| REUSABLE CABLES FOR MONOPOLAR INSTRUMENTS & GENERATORS   | 148         |
| <b>IRRIGATION &amp; SUCTION INSTRUMENTS</b>  | <b>PAGE</b> |
| IRRIGATION / SUCTION TUBES   | 150-152     |
| IRRIGATION / SUCTION SYSTEMS   | 153         |
| SINGLE TRUMPET OR PISTOL GRIP SUCTION / IRRIGATION SYSTEMS   | 154         |
| TRIPLE FUNCTION SUCTION / IRRIGATION CANNULA   | 154         |
| IRRIGATION / SUCTION TUBES FOR DISPOSABLE HANDLES  | 155-156     |
| MONOPOLAR RF ELECTRODES FOR DISPOSABLE HANDLES   | 157         |
| STORZ TYPE LAPAROSCOPIC ELECTRODES   | 158-159     |
| <b>TESTING, CLEANING, STERILIZATION &amp; STORAGE</b>  | <b>PAGE</b> |
| ELMED ENDO-TEST UNITS FOR INSULATION TESTING   | 161         |
| ELMED WATER JET CLEANING GUN, ULTRASTOP “PRO MED” ANTI-FOGGING AGENT, LUBRICATING OIL FOR SURGICAL INSTRUMENTS | 162         |
| CLEANING BRUSHES FOR ENDOSCOPIC INSTRUMENTS  | 163         |
| STERILIZATION & STORAGE CONTAINERS FOR LAP INSTRUMENTS & SCOPES  | 164-166     |
| SERVICE AND REPAIR   | 167         |

# TROCARS CANNULAS & SCOPES



MINIMALLY INVASIVE SURGERY HAS RAPIDLY EXPANDED INTO NEW CLINICAL APPLICATIONS, CREATING THE NEED FOR INCREASINGLY ADVANCED SURGICAL INSTRUMENTS. THE USE OF HIGH-QUALITY HD LAPAROSCOPES, TROCARS, AND SLEEVES IS ESSENTIAL FOR PRECISION AND RELIABILITY DURING MULTI-PUNCTURE SURGICAL PROCEDURES.

ELMED MANUFACTURES A COMPREHENSIVE RANGE OF REUSABLE HD LAPAROSCOPES, TROCARS, AND SLEEVES THAT DELIVER BOTH SIGNIFICANT ECONOMIC ADVANTAGES AND TECHNOLOGICAL SUPERIORITY COMPARED TO DISPOSABLE SYSTEMS. EACH PRODUCT IS CRAFTED USING ONLY THE HIGHEST-GRADE MATERIALS AND EXCEPTIONAL MANUFACTURING EXPERTISE TO ENSURE OUTSTANDING PERFORMANCE, DURABILITY, AND CLINICAL CONFIDENCE.



# ELMED EOS HD LAPAROSCOPES



MADE IN THE USA



| ITEM NO.        | SIZE        | DESCRIPTION  |
|-----------------|-------------|--|
| <b>52205-00</b> | 5MM X 26CM  | 0° LAPAROSCOPE, HD, AUTOCLAVABLE, COLOR CODE: BLUE   |
| <b>52205-01</b> | 5MM X 26CM  | 30° LAPAROSCOPE, HD, AUTOCLAVABLE, COLOR CODE: RED   |
| <b>52205-02</b> | 5MM X 30CM  | 0° LAPAROSCOPE, HD, AUTOCLAVABLE, COLOR CODE: BLUE   |
| <b>52205-03</b> | 5MM X 30CM  | 30° LAPAROSCOPE, HD, AUTOCLAVABLE, COLOR CODE: RED   |
| <b>52245-04</b> | 5MM X 30CM  | 45° LAPAROSCOPE, HD, AUTOCLAVABLE, COLOR CODE: BLACK |
| <b>52215-00</b> | 5MM X 50CM  | 0° LAPAROSCOPE, HD, AUTOCLAVABLE, COLOR CODE: BLUE   |
| <b>52215-01</b> | 5MM X 50CM  | 30° LAPAROSCOPE, HD, AUTOCLAVABLE, COLOR CODE: RED   |
| <b>52215-02</b> | 5MM X 50CM  | 45° LAPAROSCOPE, HD, AUTOCLAVABLE, COLOR CODE: BLACK |
| <b>52210-00</b> | 10MM X 30CM | 0° LAPAROSCOPE, HD, AUTOCLAVABLE, COLOR CODE: BLUE   |
| <b>52210-01</b> | 10MM X 30CM | 30° LAPAROSCOPE, HD, AUTOCLAVABLE, COLOR CODE: RED   |
| <b>52210-02</b> | 10MM X 30CM | 45° LAPAROSCOPE, HD, AUTOCLAVABLE, COLOR CODE: BLACK |
| <b>52515-00</b> | 10MM X 50CM | 0° LAPAROSCOPE, HD, AUTOCLAVABLE, COLOR CODE: BLUE   |
| <b>52515-01</b> | 10MM X 50CM | 30° LAPAROSCOPE, HD, AUTOCLAVABLE, COLOR CODE: RED   |
| <b>52515-02</b> | 10MM X 50CM | 45° LAPAROSCOPE, HD, AUTOCLAVABLE, COLOR CODE: BLACK |

## ELMED TP4-OPTIC CLEAR TELESCOPE PRE-HEATER

TO PREVENT FOGGING OF THE OPTICAL SYSTEM ON ENDOSCOPES AT THE TIME OF INSERTION, PREHEATING HAS BEEN WIDELY ACCEPTED. WITH THE ELMED TP 11 TELESCOPE PREHEATER, WE PROVIDE A UNIQUE UNIT WITH VARIABLE TEMPERATURE RANGE AND DIGITAL READOUT.

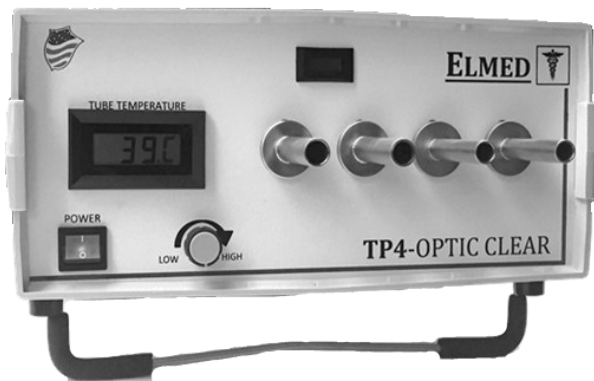

| ITEM NO.           | DESCRIPTION  |
|--------------------|--|
| <b>52033-50</b>    | <i>ELMED TP 11 TELESCOPE PREHEATER INCLUDING (4) AUTOCLAVABLE TELESCOPE TUBES, STANDARD 10MM (QTY.2), 5MM (QTY.1), AND 4MM (QTY.1)</i> |
| <b>52003-45-04</b> | 4MM DIA., REPLACEMENT TUBE   |
| <b>52003-45-05</b> | 5MM DIA., REPLACEMENT TUBE   |
| <b>52003-45-10</b> | 10MM DIA., REPLACEMENT TUBE  |

THIS UNIT CONNECTS TO ANY CONVENTIONAL OUTLET (115 V), OTHER VOLTAGES ARE AVAILABLE UPON REQUEST





# ELMED EOS HD OPERATING LAPAROSCOPES



MADE IN THE USA

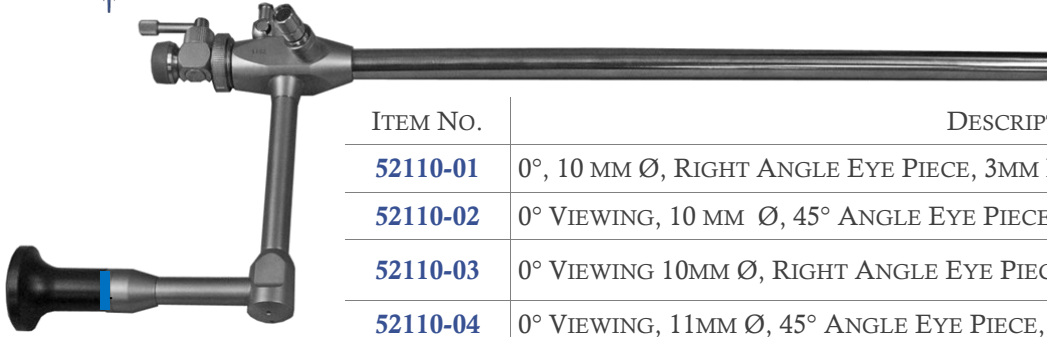

| ITEM NO.        | DESCRIPTION  |
|-----------------|--|
| <b>52110-01</b> | 0°, 10 MM Ø, RIGHT ANGLE EYE PIECE, 3MM INSTRUMENT CHANNEL         |
| <b>52110-02</b> | 0° VIEWING, 10 MM Ø, 45° ANGLE EYE PIECE, 3MM INSTRUMENT CHANNEL.  |
| <b>52110-03</b> | 0° VIEWING 10MM Ø, RIGHT ANGLE EYE PIECE, 5.5MM INSTRUMENT CHANNEL |
| <b>52110-04</b> | 0° VIEWING, 11MM Ø, 45° ANGLE EYE PIECE, 6MM INSTRUMENT CHANNEL    |
| <b>52110-05</b> | 0° VIEWING, 11MM Ø, RIGHT ANGLE EYE PIECE, 6 MM INSTRUMENT CHANNEL |
| <b>52110-06</b> | 0° VIEWING, 12MM Ø, RIGHT ANGLE EYE PIECE, 7 MM INSTRUMENT CHANNEL |
| <b>52110-07</b> | 0° VIEWING, 12MM Ø, 45° ANGLE EYE PIECE, 7 MM INSTRUMENT CHANNEL   |
| <b>52110-08</b> | 0° VIEWING, 10MM Ø, 45° ANGLE EYE PIECE, 5.5 MM INSTRUMENT CHANNEL |

## REPLACEMENT PARTS FOR ELMED EOS HD OPERATING LAPAROSCOPES

### STOPCOCK ORDERING INFORMATION:

| ITEM NO.           | DESCRIPTION   |
|--------------------|---|
| <b>52110-00-01</b> | REPLACEMENT STOPCOCK AND INSTRUMENT CHANNEL SEAL: 3MM DIA., FOR ELMED SCOPES (#52110-01 & 52110-02)   |
| <b>52110-00-03</b> | REPLACEMENT STOPCOCK AND INSTRUMENT CHANNEL SEAL: 5.5MM DIA., FOR ELMED SCOPES (#52110-03 & 52110-08) |
| <b>52110-00-05</b> | REPLACEMENT STOPCOCK AND INSTRUMENT CHANNEL SEAL: 6MM DIA., FOR ELMED SCOPES (#52110-04 & 52110-05)   |
| <b>52110-00-06</b> | REPLACEMENT STOPCOCK AND INSTRUMENT CHANNEL SEAL: 7MM DIA., FOR ELMED SCOPES (#52110-06 & 52110-07)   |

### SPECIAL PARTS & CLEANING BRUSHES ORDERING INFORMATION:

|                 |  |
|-----------------|--|
| <b>52110-20</b> | ADAPTER FOR ACMI FALLOPIAN RING APPLICATOR FOR ELMED SCOPE #52110-06           |
| <b>52003-29</b> | CLEANING BRUSH FOR OPERATING SCOPE WITH 3MM DIA. INSTRUMENT CHANNEL, 12/PKG.   |
| <b>52003-31</b> | CLEANING BRUSH FOR OPERATING SCOPE WITH 5.5MM DIA. INSTRUMENT CHANNEL, 12/PKG. |
| <b>52003-23</b> | CLEANING BRUSH FOR OPERATING SCOPE WITH 6MM DIA. INSTRUMENT CHANNEL, 12/PKG.   |
| <b>52003-25</b> | CLEANING BRUSH FOR OPERATING SCOPE WITH 7MM DIA. INSTRUMENT CHANNEL, 12/PKG.   |

### SEALING CAP ORDERING INFORMATION:

|                 |   |
|-----------------|---|
| <b>52003-02</b> | REPLACEMENT SEALING CAP FOR OPERATING SCOPE WITH 3MM DIA. INSTRUMENT CHANNEL, 12/PKG.   |
| <b>52003-04</b> | REPLACEMENT SEALING CAP FOR OPERATING SCOPE WITH 5.5MM DIA. INSTRUMENT CHANNEL, 12/PKG. |
| <b>52003-05</b> | REPLACEMENT SEALING CAP FOR OPERATING SCOPE WITH 6MM DIA. INSTRUMENT CHANNEL, 12/PKG.   |
| <b>52003-06</b> | REPLACEMENT SEALING CAP FOR OPERATING SCOPE WITH 7MM DIA. INSTRUMENT CHANNEL, 12/PKG.   |

### PROTECTIVE RIGID SCOPE SHEATH

|                 |            |
|-----------------|------------|
| <b>37000-19</b> | 19CM (7½") |
|-----------------|------------|



WE DESIGN, MANUFACTURE & SELL THE TOOLS THE SURGEONS USE



# ELMED "LITE" THERMOPLASTIC TROCAR SLEEVES





MADE IN THE USA



*"LITE" THERMOPLASTIC , SMOOTH SLEEVE*

*"LITE" THERMOPLASTIC , THREADED SLEEVE*

| THERMOPLASTIC SMOOTH SLEEVE | DIAMETER | LENGTH | MATCHING TROCARS IN PYRAMIDAL, CONICAL OR CONICAL BLUNT STYLES                    |   |   |
|-----------------------------|----------|--------|---|---|---|
|                             |          |        |  |  |  |
| 52906-05                    | 5MM      | 60MM   | 52960-05  | 52961-05  | 52962-05  |
| 52900-05                    | 5MM      | 110MM  | 52901-05  | 52902-05  | 52903-05  |
| 52904-05                    | 5MM      | 150MM  | 52921-05  | 52922-05  | 52923-05  |
| 52900-06                    | 6MM      | 110MM  | 52901-06  | 52902-06  | 52903-06  |
| 52904-06                    | 6MM      | 150MM  | 52921-06  | 52922-06  | 52923-06  |
| 52900-08                    | 8MM      | 110MM  | 52901-08  | 52902-08  | 52903-08  |
| 52904-08                    | 8MM      | 150MM  | 52921-08  | 52922-08  | 52923-08  |
| 52900-10                    | 1MM      | 110MM  | 52901-10  | 52902-10  | 52903-10  |
| 52904-10                    | 1MM      | 150MM  | 52921-10  | 52922-10  | 52923-10  |
| 52900-11                    | 11MM     | 110MM  | 52901-11  | 52902-11  | 52903-11  |
| 52904-11                    | 11MM     | 150MM  | 52921-11  | 52922-11  | 52923-11  |
| 52900-12                    | 12MM     | 110MM  | 52901-12  | 52902-12  | 52903-12  |
| 52904-12                    | 12MM     | 150MM  | 52921-12  | 52922-12  | 52923-12  |

| THERMOPLASTIC THREADED SLEEVE | DIAMETER | LENGTH | MATCHING TROCARS IN PYRAMIDAL, CONICAL OR CONICAL BLUNT STYLES                      |   |   |
|-------------------------------|----------|--------|---|---|---|
|                               |          |        |  |  |  |
| 52906-05T                     | 5MM      | 60MM   | 52960-05  | 52961-05  | 52962-05  |
| 52900-05T                     | 5MM      | 110MM  | 52901-05  | 52902-05  | 52903-05  |
| 52904-05T                     | 5MM      | 150MM  | 52921-05  | 52922-05  | 52923-05  |
| 52900-06T                     | 6MM      | 110MM  | 52901-06  | 52902-06  | 52903-06  |
| 52904-06T                     | 6MM      | 150MM  | 52921-06  | 52922-06  | 52923-06  |
| 52900-08T                     | 8MM      | 110MM  | 52901-08  | 52902-08  | 52903-08  |
| 52904-08T                     | 8MM      | 150MM  | 52921-08  | 52922-08  | 52923-08  |
| 52900-10T                     | 1MM      | 110MM  | 52901-10  | 52902-10  | 52903-10  |
| 52904-10T                     | 1MM      | 150MM  | 52921-10  | 52922-10  | 52923-10  |
| 52900-11T                     | 11MM     | 110MM  | 52901-11  | 52902-11  | 52903-11  |
| 52904-11T                     | 11MM     | 150MM  | 52921-11  | 52922-11  | 52923-11  |
| 52900-12T                     | 12MM     | 110MM  | 52901-12  | 52902-12  | 52903-12  |
| 52904-12T                     | 12MM     | 150MM  | 52921-12  | 52922-12  | 52923-12  |





# REPLACEMENT ACCESSORIES FOR “LITE” TROCAR SLEEVES



MADE IN THE USA

| DIAMETER           | DESCRIPTION  |
|--------------------|--|
| <b>52003-16</b>    | SEALING CAP FOR 15MM TROCAR SLEEVE, 10/PKG. (FIG.3)                    |
| <b>52003-17</b>    | SEALING CAP FOR 6MM TROCAR SLEEVE, 10/PKG. (FIG.3)                     |
| <b>52003-19</b>    | SEALING CAP FOR 8MM TROCAR SLEEVE, 10/PKG. (FIG.3)                     |
| <b>52003-20</b>    | SEALING CAP FOR 10MM TROCAR SLEEVE, 10/PKG. (FIG.3)                    |
| <b>52003-60</b>    | SEALING CAP FOR 11MM TROCAR SLEEVE, 10/PKG. (FIG.3)                    |
| <b>52003-61</b>    | SEALING CAP FOR 12MM TROCAR SLEEVE, 10/PKG. (FIG.3)                    |
| <b>52003-70</b>    | SILICONE RUBBER CAP WITH STRAP 10/PKG. (FIG. 4)                        |
| <b>52900-01-10</b> | REUSABLE SILICON VALVE- 3, 4, 5, 6MM DIA. (PKG 10) (FIG.1)             |
| <b>52900-02-10</b> | REUSABLE SILICON VALVE- 7, 8, 10, 11, 12, 15MM DIA., (PKG. 10) (FIG.1) |

*MINIMUM NUMBER OF PARTS=  
SIMPLE TO CLEAN, SERVICE & ASSEMBLE*



1.



2.



3.



4.

## REUSABLE SLIDE & FLIP TOP REDUCER FOR THE ELMED “LITE” TROCAR CANNULA SYSTEM



| ITEM NO.        | TRIPLE SLIDE REDUCER   |
|-----------------|------------------------|
| <b>52900-52</b> | 12MM TO 10/11MM TO 5MM |



| ITEM NO.        | FLIP TOP REDUCER |
|-----------------|------------------|
| <b>52900-55</b> | 10/11MM TO 5MM   |
| <b>52900-56</b> | 12MM TO 5MM      |



| ITEM NO.        | DOUBLE SLIDE REDUCER |
|-----------------|----------------------|
| <b>52900-51</b> | 11MM TO 5MM DIA.     |
| <b>52900-53</b> | 10MM TO 5MM DIA.     |
| <b>52900-54</b> | 12MM TO 5MM DIA.     |





# ELMED LIGHTWEIGHT MAGNA-CLOSE TROCAR SLEEVES



MADE IN THE USA

THE MAGNA-CLOSE TROCAR SLEEVE IS LIGHT WEIGHT & THE SIMPLEST REUSABLE TROCAR SLEEVE TO SERVICE & CLEAN. IT CONSISTS OF THREE PIECES:

1. THE LOWER HOUSING CANNULA
2. THE UPPER HOUSING
3. THE VALVE PLATE: ELMED MAGNA-CLOSE TROCARS & SLEEVES FEATURE A LIGHTWEIGHT METAL TROCAR SLEEVES W/ MAGNETIC PLATE VALVE & INSUFFLATION PORT



*LIGHTWEIGHT MAGNA-CLOSE SMOOTH SLEEVE*



*LIGHTWEIGHT MAGNA-CLOSE THREADED SLEEVE*

| SMOOTH SLEEVE W/<br>PORT | DIAMETER | LENGTH | MATCHING TROCARS IN PYRAMIDAL,<br>CONICAL OR CONICAL BLUNT STYLES |          |          |
|--------------------------|----------|--------|---|----------|----------|
|                          |          |        |   |          |          |
| 52205-113                | 5MM      | 110MM  | 52205-11  | 52205-12 | 52205-24 |
| 52205-213                | 5MM      | 150MM  | 52205-05  | 52205-04 | 52205-25 |
| 52206-113                | 6MM      | 110MM  | 52206-08  | 52206-12 | 52206-22 |
| 52206-213                | 6MM      | 150MM  | 52206-14  | 52206-15 | 52206-23 |
| 52208-113                | 8MM      | 110MM  | 52208-11  | 52208-12 | 52208-18 |
| 52208-213                | 8MM      | 150MM  | 52208-14  | 52208-15 | 52208-19 |
| 52210-113                | 10MM     | 110MM  | 52210-11  | 52110-12 | 52210-18 |
| 52210-213                | 10MM     | 150MM  | 52210-14  | 52210-15 | 52210-19 |
| 52211-113                | 11MM     | 110MM  | 52110-15  | 52110-16 | 52110-22 |
| 52211-213                | 11MM     | 150MM  | 52110-18  | 52110-19 | 52110-23 |
| 52212-113                | 12MM     | 110MM  | 52212-11  | 52212-12 | 52212-18 |
| 52212-213                | 12MM     | 150MM  | 52212-14  | 52212-15 | 52212-19 |

| THREADED SLEEVE W/<br>PORT | DIAMETER | LENGTH | MATCHING TROCARS IN PYRAMIDAL,<br>CONICAL OR CONICAL BLUNT STYLES |          |          |
|----------------------------|----------|--------|---|----------|----------|
|                            |          |        |   |          |          |
| 52205-113T                 | 5MM      | 110MM  | 52205-11  | 52205-12 | 52205-24 |
| 52205-213T                 | 5MM      | 150MM  | 52205-05  | 52205-04 | 52205-25 |
| 52206-113T                 | 6MM      | 110MM  | 52206-08  | 52206-12 | 52206-22 |
| 52206-213T                 | 6MM      | 150MM  | 52206-14  | 52206-15 | 52206-23 |
| 52208-113T                 | 8MM      | 110MM  | 52208-11  | 52208-12 | 52208-18 |
| 52208-213T                 | 8MM      | 150MM  | 52208-14  | 52208-15 | 52208-19 |
| 52210-113T                 | 10MM     | 110MM  | 52210-11  | 52110-12 | 52210-18 |
| 52210-213T                 | 10MM     | 150MM  | 52210-14  | 52210-15 | 52210-19 |
| 52211-113T                 | 11MM     | 110MM  | 52110-15  | 52110-16 | 52110-22 |
| 52211-213T                 | 11MM     | 150MM  | 52110-18  | 52110-19 | 52110-23 |
| 52212-113T                 | 12MM     | 110MM  | 52212-11  | 52212-12 | 52212-18 |
| 52212-213T                 | 12MM     | 150MM  | 52212-14  | 52212-15 | 52212-19 |

## REPLACEMENT SEALING CAPS

|          |   |
|----------|---|
| 52003-50 | SEALING CAP FOR 5MM MAGNA CLOSE TROCAR SLEEVE, 10/PKG.  |
| 52003-51 | SEALING CAP FOR 8MM MAGNA CLOSE TROCAR SLEEVE, 10/PKG.  |
| 52003-52 | SEALING CAP FOR 10MM MAGNA CLOSE TROCAR SLEEVE, 10/PKG. |
| 52003-53 | SEALING CAP FOR 11MM MAGNA CLOSE TROCAR SLEEVE, 10/PKG. |



WE DESIGN, MANUFACTURE & SELL THE TOOLS THE SURGEONS USE



# STAINLESS STEEL TROCAR SLEEVES W/ TRUMPET VALVE



MADE IN THE USA



STAINLESS STEEL SMOOTH SLEEVE W/  
INSUFFLATION PORT

STAINLESS STEEL THREADED SLEEVE W/  
INSUFFLATION PORT

| STAINLESS STEEL<br>SMOOTH<br>SLEEVE W/<br>PORT | DIAMETER | LENGTH | MATCHING TROCARS IN<br>PYRAMIDAL, CONICAL OR<br>CONICAL BLUNT STYLES              |   |   |
|--|----------|--------|---|---|---|
|  |          |        |  |  |  |
| <b>52205-09</b>                                | 5MM      | 110MM  | 52205-11  | 52205-12  | 52205-24  |
| <b>52205-08</b>                                | 5MM      | 150MM  | 52205-05  | 52205-04  | 52205-25  |
| <b>52206-10</b>                                | 6MM      | 110MM  | 52206-08  | 52206-12  | 52206-22  |
| <b>52206-13</b>                                | 6MM      | 150MM  | 52206-14  | 52206-15  | 52206-23  |
| <b>52208-10</b>                                | 8MM      | 110MM  | 52208-11  | 52208-12  | 52208-18  |
| <b>52208-13</b>                                | 8MM      | 150MM  | 52208-14  | 52208-15  | 52208-19  |
| <b>52210-10</b>                                | 10MM     | 110MM  | 52210-11  | 52110-12  | 52210-18  |
| <b>52210-13</b>                                | 10MM     | 150MM  | 52210-14  | 52210-15  | 52210-19  |
| <b>52211-14</b>                                | 11MM     | 110MM  | 52110-15  | 52110-16  | 52110-22  |
| <b>52211-17</b>                                | 11MM     | 150MM  | 52110-18  | 52110-19  | 52110-23  |
| <b>52212-10</b>                                | 12MM     | 110MM  | 52212-11  | 52212-12  | 52212-18  |
| <b>52212-13</b>                                | 12MM     | 150MM  | 52212-14  | 52212-15  | 52212-19  |

| STAINLESS STEEL<br>THREADED<br>SLEEVE W/<br>PORT | DIAMETER | LENGTH | MATCHING TROCARS IN<br>PYRAMIDAL, CONICAL OR<br>CONICAL BLUNT STYLES                |   |   |
|--|----------|--------|---|---|---|
|  |          |        |  |  |  |
| <b>52205-09T</b>                                 | 5MM      | 110MM  | 52205-11  | 52205-12  | 52205-24  |
| <b>52205-08T</b>                                 | 5MM      | 150MM  | 52205-05  | 52205-04  | 52205-25  |
| <b>52206-10T</b>                                 | 6MM      | 110MM  | 52206-08  | 52206-12  | 52206-22  |
| <b>52206-13T</b>                                 | 6MM      | 150MM  | 52206-14  | 52206-15  | 52206-23  |
| <b>52208-10T</b>                                 | 8MM      | 110MM  | 52208-11  | 52208-12  | 52208-18  |
| <b>52208-13T</b>                                 | 8MM      | 150MM  | 52208-14  | 52208-15  | 52208-19  |
| <b>52210-10T</b>                                 | 10MM     | 110MM  | 52210-11  | 52110-12  | 52210-18  |
| <b>52210-13T</b>                                 | 10MM     | 150MM  | 52210-14  | 52210-15  | 52210-19  |
| <b>52210-14T</b>                                 | 11MM     | 110MM  | 52110-15  | 52110-16  | 52110-22  |
| <b>52210-17T</b>                                 | 11MM     | 150MM  | 52110-18  | 52110-19  | 52110-23  |
| <b>52212-10T</b>                                 | 12MM     | 110MM  | 52212-11  | 52212-12  | 52212-18  |
| <b>52212-13T</b>                                 | 12MM     | 150MM  | 52212-14  | 52212-15  | 52212-19  |

## REPLACEMENT SEALING CAPS

| ITEM NO.        | DESCRIPTION                                 |
|-----------------|---|
| <b>52003-16</b> | SEALING CAP FOR 15MM TROCAR SLEEVE, 10/PKG. |
| <b>52003-17</b> | SEALING CAP FOR 6MM TROCAR SLEEVE, 10/PKG.  |
| <b>52003-18</b> | SEALING CAP FOR 7MM TROCAR SLEEVE, 10/PKG.  |
| <b>52003-19</b> | SEALING CAP FOR 8MM TROCAR SLEEVE, 10/PKG.  |
| <b>52003-20</b> | SEALING CAP FOR 10MM TROCAR SLEEVE, 10/PKG. |
| <b>52003-60</b> | SEALING CAP FOR 11MM TROCAR SLEEVE, 10/PKG. |
| <b>52003-61</b> | SEALING CAP FOR 12MM TROCAR SLEEVE, 10/PKG. |



WE DESIGN, MANUFACTURE & SELL THE TOOLS THE SURGEONS USE



# ELMED STAINLESS STEEL SAFETY TROCARS, SPRING LOADED



MADE IN THE USA

INNER CUTTING ASSEMBLY IS SPRING LOADED TO PROTECT CONTENTS OF THE ABDOMINAL CAVITY UPON PENETRATION



| DIA. | STANDARD 110MM LENGTH | EXTRA LONG 150MM LENGTH |
|------|-----------------------|-------------------------|
| 5MM  | 52205-112             | 52205-212               |
| 6MM  | 52206-112             | 52206-212               |
| 8MM  | 52208-112             | 52208-212               |
| 10MM | 52210-112             | 52210-212               |
| 11MM | 52211-112             | 52211-212               |
| 12MM | 52212-112             | 52212-212               |



**STYLE A:** BLUNT OBTURATOR W/ OBLIQUE SAFETY SPRING LOADED CUTTING SHIELD

## DILATION SETS-COMplete SLEEVE & PROBE



| DIA.    | STANDARD LENGTH |
|---------|-----------------|
| 5-11MM  | 52001-22        |
| 10-15MM | 52001-23        |

## REDUCERS



| DIA.        | STANDARD REDUCER FOR FULL LENGTH OF SLEEVE | REDUCER W/ FLIP VALVE FOR SLEEVE TOP OPENING |
|-------------|--|--|
| 5MM TO 3MM  | 52203-08-01                                | 52205-80                                     |
| 12MM TO 5MM | 52212-16                                   | 52212-80                                     |
| 10MM TO 5MM | 52210-16                                   | 52210-80                                     |
| 11MM TO 5MM | 52110-30                                   | 52210-80                                     |
| 12MM TO 5MM | 52212-20                                   | 52212-81                                     |





# ELMED HASSON CANNULA FOR OPEN LAPAROSCOPY



MADE IN THE USA

## CLASSIC HASSON CANNULA

TRUMPET VALVE, INCLUDING TROCAR, SLEEVE & CONE SUTURE POST



| DIA. | STANDARD LENGTH |
|------|-----------------|
| 5MM  | <b>52205-99</b> |
| 8MM  | <b>52208-99</b> |
| 10MM | <b>52210-99</b> |
| 11MM | <b>52110-99</b> |
| 12MM | <b>52212-99</b> |

## LIGHTWEIGHT HASSON CANNULA

MAGNA-CLOSE, INCLUDING TROCAR, SLEEVE & CONE SUTURE POST



| DIA. | STANDARD LENGTH  |
|------|------------------|
| 5MM  | <b>52205-199</b> |
| 8MM  | <b>52208-199</b> |
| 10MM | <b>52210-199</b> |
| 11MM | <b>52110-199</b> |
| 12MM | <b>52212-199</b> |

## REPLACEMENT SEALING CAPS

| ITEM NO.          | DESCRIPTION   |
|-------------------|---|
| <b>52003-16</b>   | SEALING CAP FOR 5MM TROCAR SLEEVE, 10/PKG.              |
| <b>52003-19</b>   | SEALING CAP FOR 8MM TROCAR SLEEVE, 10/PKG.              |
| <b>52003-20</b>   | SEALING CAP FOR 10MM TROCAR SLEEVE, 10/PKG.             |
| <b>52003-60</b>   | SEALING CAP FOR 11MM TROCAR SLEEVE, 10/PKG.             |
| <b>52003-61</b>   | SEALING CAP FOR 12MM TROCAR SLEEVE, 10/PKG.             |
| <b>52003-9905</b> | SEALING CAP FOR 5MM DIA. HASSON CANNULA CONE (10/PKG.)  |
| <b>52003-9908</b> | SEALING CAP FOR 8MM DIA. HASSON CANNULA CONE (10/PKG.)  |
| <b>52003-9910</b> | SEALING CAP FOR 10MM DIA. HASSON CANNULA CONE (10/PKG.) |
| <b>52003-9911</b> | SEALING CAP FOR 11MM DIA. HASSON CANNULA CONE (10/PKG.) |
| <b>52003-9912</b> | SEALING CAP FOR 12MM DIA. HASSON CANNULA CONE (10/PKG.) |

## HASSON "S-SHAPED" RETRACTORS

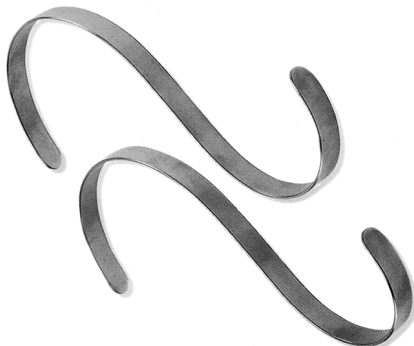

| ITEM NO.        | DESCRIPTION  |
|-----------------|--|
| <b>52110-98</b> | HASSON S-SHAPED RETRACTOR, 3/8" (10MM BLADE WIDTH, SET OF 2) |
| <b>52110-97</b> | HASSON S-SHAPED RETRACTOR, 1/2" (10MM BLADE WIDTH, SET OF 2) |
| <b>52110-96</b> | HASSON S-SHAPED RETRACTOR, 3/4" (10MM BLADE WIDTH, SET OF 2) |
| <b>52110-95</b> | HASSON S-SHAPED RETRACTOR, 1" (10MM BLADE WIDTH, SET OF 2)   |

\*\*\*CUSTOM WIDTHS AVAILABLE...PLEASE SPECIFY WHEN ORDERING



WE DESIGN, MANUFACTURE & SELL THE TOOLS THE SURGEONS USE



# LAPAROSCOPIC ADAPTERS



MADE IN THE USA

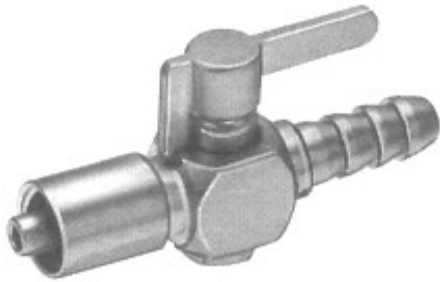

| ITEM NO.        | DESCRIPTION                                       |
|-----------------|---|
| <b>52000-32</b> | STOPCOCK WITH MALE LUER LOCK & 6MM Ø BARB FITTING |
| <b>52000-33</b> | STOPCOCK WITH MALE LUER LOCK & 8MM Ø BARB FITTING |



| ITEM NO.        | DESCRIPTION                                |
|-----------------|--|
| <b>52000-16</b> | MALE LUER LOCK 6MM Ø BARB HOSE END FITTING |
| <b>52000-17</b> | MALE LUER LOCK 8MM Ø BARB HOSE END FITTING |



| ITEM NO.        | DESCRIPTION                                  |
|-----------------|--|
| <b>52000-18</b> | FEMALE LUER LOCK 6MM Ø BARB HOSE END FITTING |
| <b>52000-19</b> | FEMALE LUER LOCK 8MM Ø BARB HOSE END FITTING |



# VALLEY SERIES



## ONE PIECE RIGID LAPAROSCOPIC INSTRUMENTS

THE VALLEY SERIES 5MM & 10MM RIGID INSTRUMENTS ARE OUR **CLASSIC ONE-PIECE, NON-ROTATABLE** INSTRUMENTS WITH FLUSH PORTS FOR EASY CLEANING. ALL ARE AVAILABLE WITH ANY OF OUR SELECTION OF HANDLES.

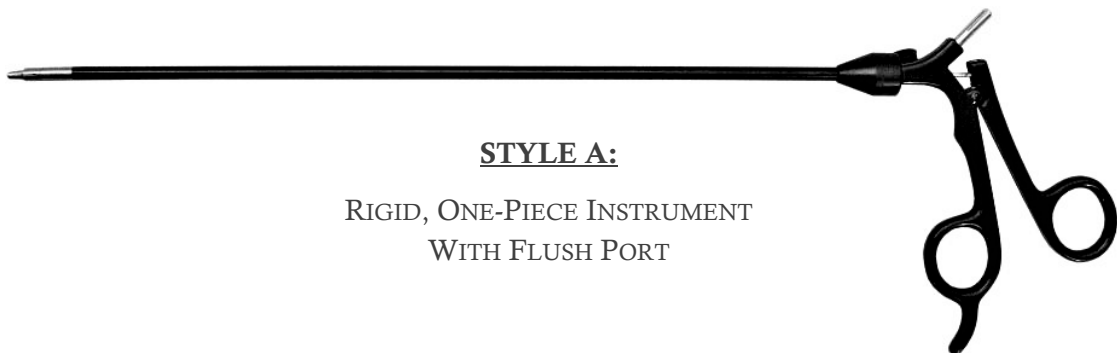

### STYLE A:

RIGID, ONE-PIECE INSTRUMENT  
WITH FLUSH PORT



# HANDLES: INSULATED & CARBON FIBER



MADE IN THE USA

## 52555-40-01

INSULATED STAINLESS STEEL W/ RF POST (TYPE 1)



## 52555-40-02

INSULATED STAINLESS STEEL W/ RF-POST & RATCHET (TYPE 2)



## 52555-40-05

INSULATED W/ RF-POST & RATCHET (TYPE 5)



## 52555-40-06

LIGHTWEIGHT CARBON FIBER W/ RF-POST & ON DEMAND ON/OFF RATCHET (TYPE 6)



## 52555-40-07

LIGHTWEIGHT CARBON-FIBER W/ RF POST, RATCHET / RATCHET DEFEATING (TYPE 7)



## 52555-40-08

LIGHTWEIGHT CARBON-FIBER W/ RF POST, ON DEMAND FRENCH ON/OFF RATCHET (TYPE 8)



## 52555-40-09

LIGHTWEIGHT CARBON-FIBER W/ RF POST, W/ LARGE FINGER LOOPS (TYPE 9)



## 52555-40-10

LIGHTWEIGHT CARBON-FIBER W/ RF POST, RATCHET / RATCHET DEFEATING W/ LARGE FINGER LOOPS (TYPE 10)



## 52555-40-14

INSULATED STAINLESS STEEL LINATEC-WECK STYLE W/ LONG SHANKS (TYPE 14)



## 52555-40-17

LIGHTWEIGHT THERMO-PLASTIC W/ RF POST (TYPE 17)



## 52555-40-18

LIGHTWEIGHT THERMO-PLASTIC W/ RF POST, RATCHET / RATCHET DEFEATING (TYPE 18)



## 52555-40-23

LIGHTWEIGHT THERMO-PLASTIC W/ RF POST, NON-RATCHET (TYPE 23)



## 52555-40-24

LIGHTWEIGHT THERMO-PLASTIC W/ RF POST, W/ RATCHET (TYPE 24)





# HANDLES: NON-INSULATED



MADE IN THE USA

**52555-40-03**

NON-INSULATED , STAINLESS STEEL  
(TYPE 3)



**52555-40-21**

STAINLESS STEEL AXIAL HANDLE  
V-SHAPED W/ SPREADING  
SPRING & THUMB RELEASE  
RATCHET  
(TYPE 21)



**52555-40-04**

NON-INSULATED STAINLESS STEEL  
W/ RATCHET  
(TYPE 4)



**52555-40-30**

STAINLESS STEEL AXIAL HANDLE  
V-SHAPED W/ SPREADING SPRING,  
NON-RATCHET  
(TYPE 30)



**52555-40-11**

NON-INSULATED RING AXIAL  
HANDLE  
(TYPE 11)



**52555-40-19**

STAINLESS STEEL AXIAL  
HANDLE V-SHAPED, ANGLED  
DOWN W/ SPREADING SPRING  
& RATCHET  
(TYPE 19)



**52555-40-12**

NON-INSULATED RING  
AXIAL HANDLE W/ RATCHET  
(TYPE 12)



**52555-40-31**

STAINLESS STEEL AXIAL  
HANDLE V-SHAPED, ANGLED  
DOWN W/ SPREADING  
SPRING , NON RATCHET  
(TYPE 31)



**52555-40-13**

STAINLESS STEEL AXIAL  
HANDLE W/ PRECISE  
ENGAGEMENT RATCHET  
(TYPE 13)



**52555-40-26**

ALUMINUM AXIAL HANDLE  
SINGLE ACTION W/ RATCHET  
(TYPE 26)



**52555-40-15**

NON-INSULATED STAINLESS STEEL  
LINVATEC-WECK STYLE W/ QUICK  
RELEASE RATCHET & LONG SHANKS  
(TYPE 15)



**52555-40-28**

ALUMINUM AXIAL HANDLE  
SINGLE ACTION, NON-RATCHET  
(TYPE 28)



**52555-40-16**

NON-INSULATED STAINLESS STEEL  
W/ SPRING ASSIST CLOSING  
(TYPE 16)



**52555-40-27**

ALUMINUM AXIAL HANDLE,  
ANGLED DOWN, SINGLE ACTION  
W/ RATCHET  
(TYPE 27)



**52003-70**

SILICONE RUBBER CAP WITH  
STRAP  
10/PKG



**52555-40-29**

ALUMINUM AXIAL HANDLE,  
ANGLED DOWN, SINGLE ACTION,  
NON-RATCHET  
(TYPE 29)





# 5MM DISSECTORS & GRASPERS



MADE IN THE USA

**STYLE A**  
**RIGID, ONE-PIECE INSTRUMENT**  
**WITH FLUSH PORT**



| TIP ID & LENGTH                                    | HANDLE   |        | TYPE 1            | TYPE 8      | TYPE 9      | TYPE 10      | TYPE 17      | TYPE 3        | TYPE 4      |
|--|----------|--------|-------------------|-------------|-------------|--------------|--------------|---------------|-------------|
|  | DIAMETER | LENGTH |                   |             |             |              |              |               |             |
|  |          |        | INSULATED HANDLES |             |             |              |              | NON-INSULATED |             |
| MICRO REDDICK OLSEN<br>12MM TIP<br>                | 5MM      | 24CM   | 52224-01A1        | 52224-01A8  | 52224-01A9  | 52224-01A10  | 52224-01A17  | 52224-01A3    | 52224-01A4  |
|  | 5MM      | 33CM   | 52255-01A1        | 52255-01A8  | 52255-01A9  | 52255-01A10  | 52255-01A17  | 52255-01A3    | 52255-01A4  |
|  | 5MM      | 36CM   | 52236-01A1        | 52236-01A8  | 52236-01A9  | 52236-01A10  | 52236-01A17  | 52236-01A3    | 52236-01A4  |
|  | 5MM      | 45CM   | 52155-01A1        | 52155-01A8  | 52155-01A9  | 52155-01A10  | 52155-01A17  | 52155-01A3    | 52155-01A4  |
| STANDARD GRASPER W/<br>SPOON<br>12MM TIP<br>       | 5MM      | 24CM   | 52224-02A1        | 52224-02A8  | 52224-02A9  | 52224-02A10  | 52224-02A17  | 52224-02A3    | 52224-02A4  |
|  | 5MM      | 33CM   | 52255-02A1        | 52255-02A8  | 52255-02A9  | 52255-02A10  | 52255-02A17  | 52255-02A3    | 52255-02A4  |
|  | 5MM      | 36CM   | 52236-02A1        | 52236-02A8  | 52236-02A9  | 52236-02A10  | 52236-02A17  | 52236-02A3    | 52236-02A4  |
|  | 5MM      | 45CM   | 52155-02A1        | 52155-02A8  | 52155-02A9  | 52155-02A10  | 52155-02A17  | 52155-02A3    | 52155-02A4  |
| STANDARD GRASPER W/<br>SPOON, LONG<br>20MM TIP<br> | 5MM      | 24CM   | 52224-52A1        | 52224-52A8  | 52224-52A9  | 52224-52A10  | 52224-52A17  | 52224-52A3    | 52224-52A4  |
|  | 5MM      | 33CM   | 52255-52A1        | 52255-52A8  | 52255-52A9  | 52255-52A10  | 52255-52A17  | 52255-52A3    | 52255-52A4  |
|  | 5MM      | 36CM   | 52236-52A1        | 52236-52A8  | 52236-52A9  | 52236-52A10  | 52236-52A17  | 52236-52A3    | 52236-52A4  |
|  | 5MM      | 45CM   | 52155-52A1        | 52155-52A8  | 52155-52A9  | 52155-52A10  | 52155-52A17  | 52155-52A3    | 52155-52A4  |
| STANDARD GRASPER<br>12MM TIP<br>                   | 5MM      | 24CM   | 52224-03A1        | 52224-03A8  | 52224-03A9  | 52224-03A10  | 52224-03A17  | 52224-03A3    | 52224-03A4  |
|  | 5MM      | 33CM   | 52255-03A1        | 52255-03A8  | 52255-03A9  | 52255-03A10  | 52255-03A17  | 52255-03A3    | 52255-03A4  |
|  | 5MM      | 36CM   | 52236-03A1        | 52236-03A8  | 52236-03A9  | 52236-03A10  | 52236-03A17  | 52236-03A3    | 52236-03A4  |
|  | 5MM      | 45CM   | 52155-03A1        | 52155-03A8  | 52155-03A9  | 52155-03A10  | 52155-03A17  | 52155-03A3    | 52155-03A4  |
| BULLET-NOSE GRASPER W/<br>SPOON<br>12MM TIP<br>    | 5MM      | 24CM   | 52224-04A1        | 52224-04A8  | 52224-04A9  | 52224-04A10  | 52224-04A17  | 52224-04A3    | 52224-04A4  |
|  | 5MM      | 33CM   | 52255-04A1        | 52255-04A8  | 52255-04A9  | 52255-04A10  | 52255-04A17  | 52255-04A3    | 52255-04A4  |
|  | 5MM      | 36CM   | 52236-04A1        | 52236-04A8  | 52236-04A9  | 52236-04A10  | 52236-04A17  | 52236-04A3    | 52236-04A4  |
|  | 5MM      | 45CM   | 52155-04A1        | 52155-04A8  | 52155-04A9  | 52155-04A10  | 52155-04A17  | 52155-04A3    | 52155-04A4  |
| TAPERED DOLPHIN-NOSE<br>15MM TIP<br>               | 5MM      | 24CM   | 52224-05A1        | 52224-05A8  | 52224-05A9  | 52224-05A10  | 52224-05A17  | 52224-05A3    | 52224-05A4  |
|  | 5MM      | 33CM   | 52255-05A1        | 52255-05A8  | 52255-05A9  | 52255-05A10  | 52255-05A17  | 52255-05A3    | 52255-05A4  |
|  | 5MM      | 36CM   | 52236-05A1        | 52236-05A8  | 52236-05A9  | 52236-05A10  | 52236-05A17  | 52236-05A3    | 52236-05A4  |
|  | 5MM      | 45CM   | 52155-05A1        | 52155-05A8  | 52155-05A9  | 52155-05A10  | 52155-05A17  | 52155-05A3    | 52155-05A4  |
| TAPERED DOLPHIN-NOSE W/<br>SPOON<br>15MM TIP<br>   | 5MM      | 24CM   | 52224-105A1       | 52224-105A8 | 52224-105A9 | 52224-105A10 | 52224-105A17 | 52224-105A3   | 52224-105A4 |
|  | 5MM      | 33CM   | 52255-105A1       | 52255-105A8 | 52255-105A9 | 52255-105A10 | 52255-105A17 | 52255-105A3   | 52255-105A4 |
|  | 5MM      | 36CM   | 52236-105A1       | 52236-105A8 | 52236-105A9 | 52236-105A10 | 52236-105A17 | 52236-105A3   | 52236-105A4 |
|  | 5MM      | 45CM   | 52155-105A1       | 52155-105A8 | 52155-105A9 | 52155-105A10 | 52155-105A17 | 52155-105A3   | 52155-105A4 |





# 5MM DISSECTORS & GRASPERS



MADE IN THE USA



| TIP ID & LENGTH                                    | HANDLE   |        | TYPE 1            | TYPE 8      | TYPE 9      | TYPE 10      | TYPE 17      | TYPE 3        | TYPE 4      |
|--|----------|--------|-------------------|-------------|-------------|--------------|--------------|---------------|-------------|
|  | DIAMETER | LENGTH |                   |             |             |              |              |               |             |
|  |          |        | INSULATED HANDLES |             |             |              |              | NON-INSULATED |             |
| TAPERED DOLPHIN-NOSE W/ LONG SPOON<br>22MM TIP<br> | 5MM      | 24CM   | 52224-205A1       | 52224-205A8 | 52224-205A9 | 52224-205A10 | 52224-205A17 | 52224-205A3   | 52224-205A4 |
|  | 5MM      | 33CM   | 52255-205A1       | 52255-205A8 | 52255-205A9 | 52255-205A10 | 52255-205A17 | 52255-205A3   | 52255-205A4 |
|  | 5MM      | 36CM   | 52236-205A1       | 52236-205A8 | 52236-205A9 | 52236-205A10 | 52236-205A17 | 52236-205A3   | 52236-205A4 |
|  | 5MM      | 45CM   | 52155-205A1       | 52155-205A8 | 52155-205A9 | 52155-205A10 | 52155-205A17 | 52155-205A3   | 52155-205A4 |
| MARYLAND DISSECTOR<br>18MM TIP<br>                 | 5MM      | 24CM   | 52224-06A1        | 52224-06A8  | 52224-06A9  | 52224-06A10  | 52224-06A17  | 52224-06A3    | 52224-06A4  |
|  | 5MM      | 33CM   | 52255-06A1        | 52255-06A8  | 52255-06A9  | 52255-06A10  | 52255-06A17  | 52255-06A3    | 52255-06A4  |
|  | 5MM      | 36CM   | 52236-06A1        | 52236-06A8  | 52236-06A9  | 52236-06A10  | 52236-06A17  | 52236-06A3    | 52236-06A4  |
|  | 5MM      | 45CM   | 52155-06A1        | 52155-06A8  | 52155-06A9  | 52155-06A10  | 52155-06A17  | 52155-06A3    | 52155-06A4  |
| TAPERED MARYLAND DISSECTOR<br>18MM TIP<br>         | 5MM      | 24CM   | 52224-106A1       | 52224-106A8 | 52224-106A9 | 52224-106A10 | 52224-106A17 | 52224-106A3   | 52224-106A4 |
|  | 5MM      | 33CM   | 52255-106A1       | 52255-106A8 | 52255-106A9 | 52255-106A10 | 52255-106A17 | 52255-106A3   | 52255-106A4 |
|  | 5MM      | 36CM   | 52236-106A1       | 52236-106A8 | 52236-106A9 | 52236-106A10 | 52236-106A17 | 52236-106A3   | 52236-106A4 |
|  | 5MM      | 45CM   | 52155-106A1       | 52155-106A8 | 52155-106A9 | 52155-106A10 | 52155-106A17 | 52155-106A3   | 52155-106A4 |
| SHORT MARYLAND DISSECTOR<br>15MM TIP<br>           | 5MM      | 24CM   | 52224-206A1       | 52224-206A8 | 52224-206A9 | 52224-206A10 | 52224-206A17 | 52224-206A3   | 52224-206A4 |
|  | 5MM      | 33CM   | 52255-206A1       | 52255-206A8 | 52255-206A9 | 52255-206A10 | 52255-206A17 | 52255-206A3   | 52255-206A4 |
|  | 5MM      | 36CM   | 52236-206A1       | 52236-206A8 | 52236-206A9 | 52236-206A10 | 52236-206A17 | 52236-206A3   | 52236-206A4 |
|  | 5MM      | 45CM   | 52155-206A1       | 52155-206A8 | 52155-206A9 | 52155-206A10 | 52155-206A17 | 52155-206A3   | 52155-206A4 |
| RIGHT ANGLE MIXTER, LONG<br>22MM TIP<br>           | 5MM      | 24CM   | 52224-07A1        | 52224-07A8  | 52224-07A9  | 52224-07A10  | 52224-07A17  | 52224-07A3    | 52224-07A4  |
|  | 5MM      | 33CM   | 52255-07A1        | 52255-07A8  | 52255-07A9  | 52255-07A10  | 52255-07A17  | 52255-07A3    | 52255-07A4  |
|  | 5MM      | 36CM   | 52236-07A1        | 52236-07A8  | 52236-07A9  | 52236-07A10  | 52236-07A17  | 52236-07A3    | 52236-07A4  |
|  | 5MM      | 45CM   | 52155-07A1        | 52155-07A8  | 52155-07A9  | 52155-07A10  | 52155-07A17  | 52155-07A3    | 52155-07A4  |
| RIGHT ANGLE MIXTER, SHORT<br>2MM TIP<br>           | 5MM      | 24CM   | 52224-59A1        | 52224-59A8  | 52224-59A9  | 52224-59A10  | 52224-59A17  | 52224-59A3    | 52224-59A4  |
|  | 5MM      | 33CM   | 52255-59A1        | 52255-59A8  | 52255-59A9  | 52255-59A10  | 52255-59A17  | 52255-59A3    | 52255-59A4  |
|  | 5MM      | 36CM   | 52236-59A1        | 52236-59A8  | 52236-59A9  | 52236-59A10  | 52236-59A17  | 52236-59A3    | 52236-59A4  |
|  | 5MM      | 45CM   | 52155-59A1        | 52155-59A8  | 52155-59A9  | 52155-59A10  | 52155-59A17  | 52155-59A3    | 52155-59A4  |
| 45° ANGLED MIXTER<br>20MM TIP<br>                  | 5MM      | 24CM   | 52224-08A1        | 52224-08A8  | 52224-08A9  | 52224-08A10  | 52224-08A17  | 52224-08A3    | 52224-08A4  |
|  | 5MM      | 33CM   | 52255-08A1        | 52255-08A8  | 52255-08A9  | 52255-08A10  | 52255-08A17  | 52255-08A3    | 52255-08A4  |
|  | 5MM      | 36CM   | 52236-08A1        | 52236-08A8  | 52236-08A9  | 52236-08A10  | 52236-08A17  | 52236-08A3    | 52236-08A4  |
|  | 5MM      | 45CM   | 52155-08A1        | 52155-08A8  | 52155-08A9  | 52155-08A10  | 52155-08A17  | 52155-08A3    | 52155-08A4  |





# 5MM DISSECTORS & GRASPERS



MADE IN THE USA

**STYLE A**  
**RIGID, ONE-PIECE INSTRUMENT**  
**WITH FLUSH PORT**

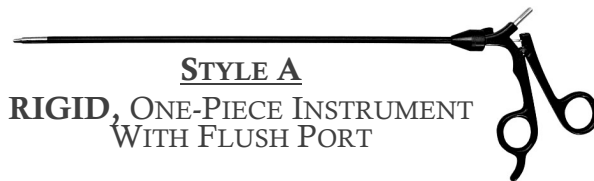

| TIP ID & LENGTH                                      | HANDLE   |        | TYPE 1            | TYPE 8      | TYPE 9      | TYPE 10      | TYPE 17      | TYPE 3        | TYPE 4      |
|--|----------|--------|-------------------|-------------|-------------|--------------|--------------|---------------|-------------|
|  | DIAMETER | LENGTH |                   |             |             |              |              |               |             |
|  |          |        | INSULATED HANDLES |             |             |              |              | NON-INSULATED |             |
| DUCKBILL GRASPER<br>12MM TIP<br>                     | 5MM      | 24CM   | 52224-09A1        | 52224-09A8  | 52224-09A9  | 52224-09A10  | 52224-09A17  | 52224-09A3    | 52224-09A4  |
|  | 5MM      | 33CM   | 52255-09A1        | 52255-09A8  | 52255-09A9  | 52255-09A10  | 52255-09A17  | 52255-09A3    | 52255-09A4  |
|  | 5MM      | 36CM   | 52236-09A1        | 52236-09A8  | 52236-09A9  | 52236-09A10  | 52236-09A17  | 52236-09A3    | 52236-09A4  |
|  | 5MM      | 45CM   | 52155-09A1        | 52155-09A8  | 52155-09A9  | 52155-09A10  | 52155-09A17  | 52155-09A3    | 52155-09A4  |
| NEEDLE-NOSE GRASPER<br>20MM TIP<br>                  | 5MM      | 24CM   | 52224-10A1        | 52224-10A8  | 52224-10A9  | 52224-10A10  | 52224-10A17  | 52224-10A3    | 52224-10A4  |
|  | 5MM      | 33CM   | 52255-10A1        | 52255-10A8  | 52255-10A9  | 52255-10A10  | 52255-10A17  | 52255-10A3    | 52255-10A4  |
|  | 5MM      | 36CM   | 52236-10A1        | 52236-10A8  | 52236-10A9  | 52236-10A10  | 52236-10A17  | 52236-10A3    | 52236-10A4  |
|  | 5MM      | 45CM   | 52155-10A1        | 52155-10A8  | 52155-10A9  | 52155-10A10  | 52155-10A17  | 52155-10A3    | 52155-10A4  |
| KELLY GRASPER<br>14MM TIP<br>                        | 5MM      | 24CM   | 52224-11A1        | 52224-11A8  | 52224-11A9  | 52224-11A10  | 52224-11A17  | 52224-11A3    | 52224-11A4  |
|  | 5MM      | 33CM   | 52255-11A1        | 52255-11A8  | 52255-11A9  | 52255-11A10  | 52255-11A17  | 52255-11A3    | 52255-11A4  |
|  | 5MM      | 36CM   | 52236-11A1        | 52236-11A8  | 52236-11A9  | 52236-11A10  | 52236-11A17  | 52236-11A3    | 52236-11A4  |
|  | 5MM      | 45CM   | 52155-11A1        | 52155-11A8  | 52155-11A9  | 52155-11A10  | 52155-11A17  | 52155-11A3    | 52155-11A4  |
| RIGHT ANGLE, LONG REACH GRASPER<br>22MM TIP<br>      | 5MM      | 24CM   | 52224-53A1        | 52224-53A8  | 52224-53A9  | 52224-53A10  | 52224-53A17  | 52224-53A3    | 52224-53A4  |
|  | 5MM      | 33CM   | 52255-53A1        | 52255-53A8  | 52255-53A9  | 52255-53A10  | 52255-53A17  | 52255-53A3    | 52255-53A4  |
|  | 5MM      | 36CM   | 52236-53A1        | 52236-53A8  | 52236-53A9  | 52236-53A10  | 52236-53A17  | 52236-53A3    | 52236-53A4  |
|  | 5MM      | 45CM   | 52155-53A1        | 52155-53A8  | 52155-53A9  | 52155-53A10  | 52155-53A17  | 52155-53A3    | 52155-53A4  |
| PETELIN DISSECTOR, 60° ANGLE, SA<br>10MM TIP<br>     | 5MM      | 24CM   | 52224-12A1        | 52224-12A8  | 52224-12A9  | 52224-12A10  | 52224-12A17  | 52224-12A3    | 52224-12A4  |
|  | 5MM      | 33CM   | 52255-12A1        | 52255-12A8  | 52255-12A9  | 52255-12A10  | 52255-12A17  | 52255-12A3    | 52255-12A4  |
|  | 5MM      | 36CM   | 52236-12A1        | 52236-12A8  | 52236-12A9  | 52236-12A10  | 52236-12A17  | 52236-12A3    | 52236-12A4  |
|  | 5MM      | 45CM   | 52155-12A1        | 52155-12A8  | 52155-12A9  | 52155-12A10  | 52155-12A17  | 52155-12A3    | 52155-12A4  |
| PETELIN DISSECTOR, 30° ANGLE, SA<br>10MM TIP<br>     | 5MM      | 24CM   | 52224-13A1        | 52224-13A8  | 52224-13A9  | 52224-13A10  | 52224-13A17  | 52224-13A3    | 52224-13A4  |
|  | 5MM      | 33CM   | 52255-13A1        | 52255-13A8  | 52255-13A9  | 52255-13A10  | 52255-13A17  | 52255-13A3    | 52255-13A4  |
|  | 5MM      | 36CM   | 52236-13A1        | 52236-13A8  | 52236-13A9  | 52236-13A10  | 52236-13A17  | 52236-13A3    | 52236-13A4  |
|  | 5MM      | 45CM   | 52155-13A1        | 52155-13A8  | 52155-13A9  | 52155-13A10  | 52155-13A17  | 52155-13A3    | 52155-13A4  |
| PETELIN STRONG RIGHT ANGLE DISSECTOR<br>10MM TIP<br> | 5MM      | 24CM   | 52224-113A1       | 52224-113A8 | 52224-113A9 | 52224-113A10 | 52224-113A17 | 52224-113A3   | 52224-113A4 |
|  | 5MM      | 33CM   | 52255-113A1       | 52255-113A8 | 52255-113A9 | 52255-113A10 | 52255-113A17 | 52255-113A3   | 52255-113A4 |
|  | 5MM      | 36CM   | 52236-113A1       | 52236-113A8 | 52236-113A9 | 52236-113A10 | 52236-113A17 | 52236-113A3   | 52236-113A4 |
|  | 5MM      | 45CM   | 52155-113A1       | 52155-113A8 | 52155-113A9 | 52155-113A10 | 52155-113A17 | 52155-113A3   | 52155-113A4 |





# 5MM DISSECTORS & GRASPERS



MADE IN THE USA

**STYLE A**  
**RIGID, ONE-PIECE INSTRUMENT**  
**WITH FLUSH PORT**

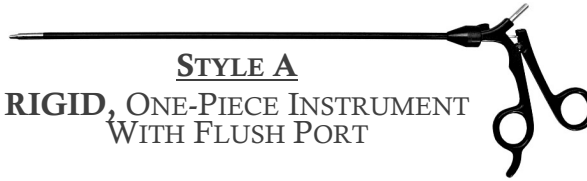

| TIP ID & LENGTH                                      | HANDLE   |        | TYPE 1            | TYPE 8      | TYPE 9      | TYPE 10      | TYPE 17      | TYPE 3        | TYPE 4      |
|--|----------|--------|-------------------|-------------|-------------|--------------|--------------|---------------|-------------|
|  | DIAMETER | LENGTH |                   |             |             |              |              |               |             |
|  |          |        | INSULATED HANDLES |             |             |              |              | NON-INSULATED |             |
| <b>MICRO GRASPER, FENESTRATED 10MM TIP</b><br>       | 5MM      | 24CM   | 52224-14A1        | 52224-14A8  | 52224-14A9  | 52224-14A10  | 52224-14A17  | 52224-14A3    | 52224-14A4  |
|  | 5MM      | 33CM   | 52255-14A1        | 52255-14A8  | 52255-14A9  | 52255-14A10  | 52255-14A17  | 52255-14A3    | 52255-14A4  |
|  | 5MM      | 36CM   | 52236-14A1        | 52236-14A8  | 52236-14A9  | 52236-14A10  | 52236-14A17  | 52236-14A3    | 52236-14A4  |
|  | 5MM      | 45CM   | 52155-14A1        | 52155-14A8  | 52155-14A9  | 52155-14A10  | 52155-14A17  | 52155-14A3    | 52155-14A4  |
| <b>COBRA GRASPER, DA 10MM TIP</b><br>                | 5MM      | 24CM   | 52224-15A1        | 52224-15A8  | 52224-15A9  | 52224-15A10  | 52224-15A17  | 52224-15A3    | 52224-15A4  |
|  | 5MM      | 33CM   | 52255-15A1        | 52255-15A8  | 52255-15A9  | 52255-15A10  | 52255-15A17  | 52255-15A3    | 52255-15A4  |
|  | 5MM      | 36CM   | 52236-15A1        | 52236-15A8  | 52236-15A9  | 52236-15A10  | 52236-15A17  | 52236-15A3    | 52236-15A4  |
|  | 5MM      | 45CM   | 52155-15A1        | 52155-15A8  | 52155-15A9  | 52155-15A10  | 52155-15A17  | 52155-15A3    | 52155-15A4  |
| <b>BABCOCK GRASPER, FENESTRATED TIP 30MM TIP</b><br> | 5MM      | 24CM   | 52224-16A1        | 52224-16A8  | 52224-16A9  | 52224-16A10  | 52224-16A17  | 52224-16A3    | 52224-16A4  |
|  | 5MM      | 33CM   | 52255-16A1        | 52255-16A8  | 52255-16A9  | 52255-16A10  | 52255-16A17  | 52255-16A3    | 52255-16A4  |
|  | 5MM      | 36CM   | 52236-16A1        | 52236-16A8  | 52236-16A9  | 52236-16A10  | 52236-16A17  | 52236-16A3    | 52236-16A4  |
|  | 5MM      | 45CM   | 52155-16A1        | 52155-16A8  | 52155-16A9  | 52155-16A10  | 52155-16A17  | 52155-16A3    | 52155-16A4  |
| <b>BABCOCK, AXIS STYLE, FENESTRATED 30MM TIP</b><br> | 5MM      | 24CM   | 52224-116A1       | 52224-116A8 | 52224-116A9 | 52224-116A10 | 52224-116A17 | 52224-116A3   | 52224-116A4 |
|  | 5MM      | 33CM   | 52255-116A1       | 52255-116A8 | 52255-116A9 | 52255-116A10 | 52255-116A17 | 52255-116A3   | 52255-116A4 |
|  | 5MM      | 36CM   | 52236-116A1       | 52236-116A8 | 52236-116A9 | 52236-116A10 | 52236-116A17 | 52236-116A3   | 52236-116A4 |
|  | 5MM      | 45CM   | 52155-116A1       | 52155-116A8 | 52155-116A9 | 52155-116A10 | 52155-116A17 | 52155-116A3   | 52155-116A4 |
| <b>PADDLE BABCOCK GRASPER 30MM TIP</b><br>           | 5MM      | 24CM   | 52224-216A1       | 52224-216A8 | 52224-216A9 | 52224-216A10 | 52224-216A17 | 52224-216A3   | 52224-216A4 |
|  | 5MM      | 33CM   | 52255-216A1       | 52255-216A8 | 52255-216A9 | 52255-216A10 | 52255-216A17 | 52255-216A3   | 52255-216A4 |
|  | 5MM      | 36CM   | 52236-216A1       | 52236-216A8 | 52236-216A9 | 52236-216A10 | 52236-216A17 | 52236-216A3   | 52236-216A4 |
|  | 5MM      | 45CM   | 52155-216A1       | 52155-216A8 | 52155-216A9 | 52155-216A10 | 52155-216A17 | 52155-216A3   | 52155-216A4 |
| <b>BABCOCK GRASPER, SHORT DELICATE 20MM TIP</b><br>  | 5MM      | 24CM   | 52224-17A1        | 52224-17A8  | 52224-17A9  | 52224-17A10  | 52224-17A17  | 52224-17A3    | 52224-17A4  |
|  | 5MM      | 33CM   | 52255-17A1        | 52255-17A8  | 52255-17A9  | 52255-17A10  | 52255-17A17  | 52255-17A3    | 52255-17A4  |
|  | 5MM      | 36CM   | 52236-17A1        | 52236-17A8  | 52236-17A9  | 52236-17A10  | 52236-17A17  | 52236-17A3    | 52236-17A4  |
|  | 5MM      | 45CM   | 52155-17A1        | 52155-17A8  | 52155-17A9  | 52155-17A10  | 52155-17A17  | 52155-17A3    | 52155-17A4  |
| <b>ALLIS GRASPER, SHORT VERSION, SA 15MM TIP</b><br> | 5MM      | 24CM   | 52224-18A1        | 52224-18A8  | 52224-18A9  | 52224-18A10  | 52224-18A17  | 52224-18A3    | 52224-18A4  |
|  | 5MM      | 33CM   | 52255-18A1        | 52255-18A8  | 52255-18A9  | 52255-18A10  | 52255-18A17  | 52255-18A3    | 52255-18A4  |
|  | 5MM      | 36CM   | 52236-18A1        | 52236-18A8  | 52236-18A9  | 52236-18A10  | 52236-18A17  | 52236-18A3    | 52236-18A4  |
|  | 5MM      | 45CM   | 52155-18A1        | 52155-18A8  | 52155-18A9  | 52155-18A10  | 52155-18A17  | 52155-18A3    | 52155-18A4  |



WE DESIGN, MANUFACTURE & SELL THE TOOLS THE SURGEONS USE



# 5MM DISSECTORS & GRASPERS



MADE IN THE USA

**STYLE A**  
**RIGID, ONE-PIECE INSTRUMENT**  
**WITH FLUSH PORT**

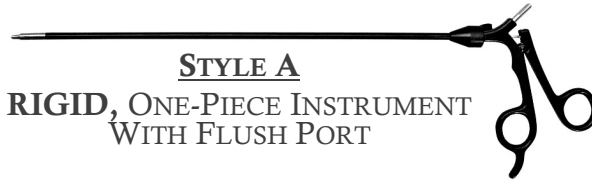

| TIP ID<br>&<br>LENGTH   | HANDLE ID |        | TYPE 1            | TYPE 8      | TYPE 9      | TYPE 10      | TYPE 17      | TYPE 3        | TYPE 4      |
|---|-----------|--------|-------------------|-------------|-------------|--------------|--------------|---------------|-------------|
|   | DIAMETER  | LENGTH |                   |             |             |              |              |               |             |
|   |           |        | INSULATED HANDLES |             |             |              |              | NON-INSULATED |             |
| ALLIS, SHORT VERSION, 3X4 TEETH, SERRATED 12MM TIP<br>        | 5MM       | 24CM   | 52224-19A1        | 52224-19A8  | 52224-19A9  | 52224-19A10  | 52224-19A17  | 52224-19A3    | 52224-19A4  |
|   | 5MM       | 33CM   | 52255-19A1        | 52255-19A8  | 52255-19A9  | 52255-19A10  | 52255-19A17  | 52255-19A3    | 52255-19A4  |
|   | 5MM       | 36CM   | 52236-19A1        | 52236-19A8  | 52236-19A9  | 52236-19A10  | 52236-19A17  | 52236-19A3    | 52236-19A4  |
|   | 5MM       | 45CM   | 52155-19A1        | 52155-19A8  | 52155-19A9  | 52155-19A10  | 52155-19A17  | 52155-19A3    | 52155-19A4  |
| ALLIS, SHORT VERSION, DBL ROW OF TEETH, SERRATED 12MM TIP<br> | 5MM       | 24CM   | 52224-119A1       | 52224-119A8 | 52224-119A9 | 52224-119A10 | 52224-119A17 | 52224-119A3   | 52224-119A4 |
|   | 5MM       | 33CM   | 52255-119A1       | 52255-119A8 | 52255-119A9 | 52255-119A10 | 52255-119A17 | 52255-119A3   | 52255-119A4 |
|   | 5MM       | 36CM   | 52236-119A1       | 52236-119A8 | 52236-119A9 | 52236-119A10 | 52236-119A17 | 52236-119A3   | 52236-119A4 |
|   | 5MM       | 45CM   | 52155-119A1       | 52155-119A8 | 52155-119A9 | 52155-119A10 | 52155-119A17 | 52155-119A3   | 52155-119A4 |
| ALLIS, LONG, DBL ROW OF TEETH, SERRATED 25MM TIP<br>          | 5MM       | 24CM   | 52224-219A1       | 52224-219A8 | 52224-219A9 | 52224-219A10 | 52224-219A17 | 52224-219A3   | 52224-219A4 |
|   | 5MM       | 33CM   | 52255-219A1       | 52255-219A8 | 52255-219A9 | 52255-219A10 | 52255-219A17 | 52255-219A3   | 52255-219A4 |
|   | 5MM       | 36CM   | 52236-219A1       | 52236-219A8 | 52236-219A9 | 52236-219A10 | 52236-219A17 | 52236-219A3   | 52236-219A4 |
|   | 5MM       | 45CM   | 52155-219A1       | 52155-219A8 | 52155-219A9 | 52155-219A10 | 52155-219A17 | 52155-219A3   | 52155-219A4 |
| ALLIS GRASPER, MEDIUM, WECK STYLE 20MM TIP<br>                | 5MM       | 24CM   | 52224-20A1        | 52224-20A8  | 52224-20A9  | 52224-20A10  | 52224-20A17  | 52224-20A3    | 52224-20A4  |
|   | 5MM       | 33CM   | 52255-20A1        | 52255-20A8  | 52255-20A9  | 52255-20A10  | 52255-20A17  | 52255-20A3    | 52255-20A4  |
|   | 5MM       | 36CM   | 52236-20A1        | 52236-20A8  | 52236-20A9  | 52236-20A10  | 52236-20A17  | 52236-20A3    | 52236-20A4  |
|   | 5MM       | 45CM   | 52155-20A1        | 52155-20A8  | 52155-20A9  | 52155-20A10  | 52155-20A17  | 52155-20A3    | 52155-20A4  |
| ALLIS GRASPER, STD. VERSION 30MM TIP<br>                      | 5MM       | 24CM   | 52224-21A1        | 52224-21A8  | 52224-21A9  | 52224-21A10  | 52224-21A17  | 52224-21A3    | 52224-21A4  |
|   | 5MM       | 33CM   | 52255-21A1        | 52255-21A8  | 52255-21A9  | 52255-21A10  | 52255-21A17  | 52255-21A3    | 52255-21A4  |
|   | 5MM       | 36CM   | 52236-21A1        | 52236-21A8  | 52236-21A9  | 52236-21A10  | 52236-21A17  | 52236-21A3    | 52236-21A4  |
|   | 5MM       | 45CM   | 52155-21A1        | 52155-21A8  | 52155-21A9  | 52155-21A10  | 52155-21A17  | 52155-21A3    | 52155-21A4  |
| ALLIS GRASPER, TC, STD. VERSION 35MM TIP<br>                  | 5MM       | 24CM   | 52224-57A1        | 52224-57A8  | 52224-57A9  | 52224-57A10  | 52224-57A17  | 52224-57A3    | 52224-57A4  |
|   | 5MM       | 33CM   | 52255-57A1        | 52255-57A8  | 52255-57A9  | 52255-57A10  | 52255-57A17  | 52255-57A3    | 52255-57A4  |
|   | 5MM       | 36CM   | 52236-57A1        | 52236-57A8  | 52236-57A9  | 52236-57A10  | 52236-57A17  | 52236-57A3    | 52236-57A4  |
|   | 5MM       | 45CM   | 52155-57A1        | 52155-57A8  | 52155-57A9  | 52155-57A10  | 52155-57A17  | 52155-57A3    | 52155-57A4  |
| DEBAKEY GRASPER 20MM TIP<br>                                  | 5MM       | 24CM   | 52224-22A1        | 52224-22A8  | 52224-22A9  | 52224-22A10  | 52224-22A17  | 52224-22A3    | 52224-22A4  |
|   | 5MM       | 33CM   | 52255-22A1        | 52255-22A8  | 52255-22A9  | 52255-22A10  | 52255-22A17  | 52255-22A3    | 52255-22A4  |
|   | 5MM       | 36CM   | 52236-22A1        | 52236-22A8  | 52236-22A9  | 52236-22A10  | 52236-22A17  | 52236-22A3    | 52236-22A4  |
|   | 5MM       | 45CM   | 52155-22A1        | 52155-22A8  | 52155-22A9  | 52155-22A10  | 52155-22A17  | 52155-22A3    | 52155-22A4  |



















# 5MM DISSECTORS & GRASPERS



MADE IN THE USA

**STYLE A**  
**RIGID, ONE-PIECE INSTRUMENT**  
**WITH FLUSH PORT**



| TIP ID & LENGTH  | HANDLE   |        | TYPE 1  | TYPE 8  | TYPE 9  | TYPE 10  | TYPE 17   | TYPE 3  | TYPE 4  |
|--|----------|--------|---|---|---|--|---|---|---|
|  | DIAMETER | LENGTH |  |  |  |  |  |  |  |
|  |          |        | INSULATED HANDLES   |   |   |  |   | NON-INSULATED   |   |
| <b>DEBAKEY GRASPER</b><br>34MM TIP<br>               | 5MM      | 24CM   | 52224-222A1   | 52224-222A8   | 52224-222A9   | 52224-222A10   | 52224-222A17  | 52224-222A3   | 52224-222A4   |
|  | 5MM      | 33CM   | 52255-222A1   | 52255-222A8   | 52255-222A9   | 52255-222A10   | 52255-222A17  | 52255-222A3   | 52255-222A4   |
|  | 5MM      | 36CM   | 52236-222A1   | 52236-222A8   | 52236-222A9   | 52236-222A10   | 52236-222A17  | 52236-222A3   | 52236-222A4   |
|  | 5MM      | 45CM   | 52155-222A1   | 52155-222A8   | 52155-222A9   | 52155-222A10   | 52155-222A17  | 52155-222A3   | 52155-222A4   |
| <b>DEBAKEY GRAPER</b><br>40MM TIP<br>                | 5MM      | 24CM   | 52224-23A1  | 52224-23A8  | 52224-23A9  | 52224-23A10  | 52224-23A17   | 52224-23A3  | 52224-23A4  |
|  | 5MM      | 33CM   | 52255-23A1  | 52255-23A8  | 52255-23A9  | 52255-23A10  | 52255-23A17   | 52255-23A3  | 52255-23A4  |
|  | 5MM      | 36CM   | 52236-23A1  | 52236-23A8  | 52236-23A9  | 52236-23A10  | 52236-23A17   | 52236-23A3  | 52236-23A4  |
|  | 5MM      | 45CM   | 52155-23A1  | 52155-23A8  | 52155-23A9  | 52155-23A10  | 52155-23A17   | 52155-23A3  | 52155-23A4  |
| <b>DEBAKEY GRASPER</b><br>60MM TIP<br>             | 5MM      | 24CM   | 52224-160A1   | 52224-160A8   | 52224-160A9   | 52224-160A10   | 52224-160A17  | 52224-160A3   | 52224-160A4   |
|  | 5MM      | 33CM   | 52255-160A1   | 52255-160A8   | 52255-160A9   | 52255-160A10   | 52255-160A17  | 52255-160A3   | 52255-160A4   |
|  | 5MM      | 36CM   | 52236-160A1   | 52236-160A8   | 52236-160A9   | 52236-160A10   | 52236-160A17  | 52236-160A3   | 52236-160A4   |
|  | 5MM      | 45CM   | 52155-160A1   | 52155-160A8   | 52155-160A9   | 52155-160A10   | 52155-160A17  | 52155-160A3   | 52155-160A4   |
| <b>HUNTER DEBAKEY, FENESTRATED</b><br>16MM TIP<br> | 5MM      | 24CM   | 52224-158A1   | 52224-158A8   | 52224-158A9   | 52224-158A10   | 52224-158A17  | 52224-158A3   | 52224-158A4   |
|  | 5MM      | 33CM   | 52255-158A1   | 52255-158A8   | 52255-158A9   | 52255-158A10   | 52255-158A17  | 52255-158A3   | 52255-158A4   |
|  | 5MM      | 36CM   | 52236-158A1   | 52236-158A8   | 52236-158A9   | 52236-158A10   | 52236-158A17  | 52236-158A3   | 52236-158A4   |
|  | 5MM      | 45CM   | 52155-158A1   | 52155-158A8   | 52155-158A9   | 52155-158A10   | 52155-158A17  | 52155-158A3   | 52155-158A4   |
| <b>HUNTER DEBAKEY, FENESTRATED</b><br>20MM TIP<br> | 5MM      | 24CM   | 52224-58A1  | 52224-58A8  | 52224-58A9  | 52224-58A10  | 52224-58A17   | 52224-58A3  | 52224-58A4  |
|  | 5MM      | 33CM   | 52255-58A1  | 52255-58A8  | 52255-58A9  | 52255-58A10  | 52255-58A17   | 52255-58A3  | 52255-58A4  |
|  | 5MM      | 36CM   | 52236-58A1  | 52236-58A8  | 52236-58A9  | 52236-58A10  | 52236-58A17   | 52236-58A3  | 52236-58A4  |
|  | 5MM      | 45CM   | 52155-58A1  | 52155-58A8  | 52155-58A9  | 52155-58A10  | 52155-58A17   | 52155-58A3  | 52155-58A4  |
| <b>HUNTER DEBAKEY, FENESTRATED</b><br>40MM TIP<br> | 5MM      | 24CM   | 52224-159A1   | 52224-159A8   | 52224-159A9   | 52224-159A10   | 52224-159A17  | 52224-159A3   | 52224-159A4   |
|  | 5MM      | 33CM   | 52255-159A1   | 52255-159A8   | 52255-159A9   | 52255-159A10   | 52255-159A17  | 52255-159A3   | 52255-159A4   |
|  | 5MM      | 36CM   | 52236-159A1   | 52236-159A8   | 52236-159A9   | 52236-159A10   | 52236-159A17  | 52236-159A3   | 52236-159A4   |
|  | 5MM      | 45CM   | 52155-159A1   | 52155-159A8   | 52155-159A9   | 52155-159A10   | 52155-159A17  | 52155-159A3   | 52155-159A4   |
| <b>HUNTER DEBAKEY, FENESTRATED</b><br>60MM TIP<br> | 5MM      | 24CM   | 52224-160A1   | 52224-160A8   | 52224-160A9   | 52224-160A10   | 52224-160A17  | 52224-160A3   | 52224-160A4   |
|  | 5MM      | 33CM   | 52255-160A1   | 52255-160A8   | 52255-160A9   | 52255-160A10   | 52255-160A17  | 52255-160A3   | 52255-160A4   |
|  | 5MM      | 36CM   | 52236-160A1   | 52236-160A8   | 52236-160A9   | 52236-160A10   | 52236-160A17  | 52236-160A3   | 52236-160A4   |
|  | 5MM      | 45CM   | 52155-160A1   | 52155-160A8   | 52155-160A9   | 52155-160A10   | 52155-160A17  | 52155-160A3   | 52155-160A4   |





# 5MM DISSECTORS & GRASPERS



MADE IN THE USA

**STYLE A**  
**RIGID, ONE-PIECE INSTRUMENT**  
**WITH FLUSH PORT**



| TIP ID & LENGTH                              | HANDLE ID |        | TYPE 1            | TYPE 8      | TYPE 9      | TYPE 10      | TYPE 17      | TYPE 3        | TYPE 4      |
|--|-----------|--------|-------------------|-------------|-------------|--------------|--------------|---------------|-------------|
|  | DIAMETER  | LENGTH |                   |             |             |              |              |               |             |
|  |           |        | INSULATED HANDLES |             |             |              |              | NON-INSULATED |             |
| DEBAKEY GRASPER, CURVED 30MM TIP<br>         | 5MM       | 24CM   | 52224-46A1        | 52224-46A8  | 52224-46A9  | 52224-46A10  | 52224-46A17  | 52224-46A3    | 52224-46A4  |
|  | 5MM       | 33CM   | 52255-46A1        | 52255-46A8  | 52255-46A9  | 52255-46A10  | 52255-46A17  | 52255-46A3    | 52255-46A4  |
|  | 5MM       | 36CM   | 52236-46A1        | 52236-46A8  | 52236-46A9  | 52236-46A10  | 52236-46A17  | 52236-46A3    | 52236-46A4  |
|  | 5MM       | 45CM   | 52155-46A1        | 52155-46A8  | 52155-46A9  | 52155-46A10  | 52155-46A17  | 52155-46A3    | 52155-46A4  |
| DEBAKEY MARYLAND GRASPER 35MM TIP<br>        | 5MM       | 24CM   | 52224-149A1       | 52224-149A8 | 52224-149A9 | 52224-149A10 | 52224-149A17 | 52224-149A3   | 52224-149A4 |
|  | 5MM       | 33CM   | 52255-149A1       | 52255-149A8 | 52255-149A9 | 52255-149A10 | 52255-149A17 | 52255-149A3   | 52255-149A4 |
|  | 5MM       | 36CM   | 52236-149A1       | 52236-149A8 | 52236-149A9 | 52236-149A10 | 52236-149A17 | 52236-149A3   | 52236-149A4 |
|  | 5MM       | 45CM   | 52155-149A1       | 52155-149A8 | 52155-149A9 | 52155-149A10 | 52155-149A17 | 52155-149A3   | 52155-149A4 |
| GLASSMAN ATRAUMATIC GRASPER 30MM TIP<br>     | 5MM       | 24CM   | 52224-24A1        | 52224-24A8  | 52224-24A9  | 52224-24A10  | 52224-24A17  | 52224-24A3    | 52224-24A4  |
|  | 5MM       | 33CM   | 52255-24A1        | 52255-24A8  | 52255-24A9  | 52255-24A10  | 52255-24A17  | 52255-24A3    | 52255-24A4  |
|  | 5MM       | 36CM   | 52236-24A1        | 52236-24A8  | 52236-24A9  | 52236-24A10  | 52236-24A17  | 52236-24A3    | 52236-24A4  |
|  | 5MM       | 45CM   | 52155-24A1        | 52155-24A8  | 52155-24A9  | 52155-24A10  | 52155-24A17  | 52155-24A3    | 52155-24A4  |
| GRASPER, CROSS SERRATED, SA 10MM TIP<br>     | 5MM       | 24CM   | 52224-25A1        | 52224-25A8  | 52224-25A9  | 52224-25A10  | 52224-25A17  | 52224-25A3    | 52224-25A4  |
|  | 5MM       | 33CM   | 52255-25A1        | 52255-25A8  | 52255-25A9  | 52255-25A10  | 52255-25A17  | 52255-25A3    | 52255-25A4  |
|  | 5MM       | 36CM   | 52236-25A1        | 52236-25A8  | 52236-25A9  | 52236-25A10  | 52236-25A17  | 52236-25A3    | 52236-25A4  |
|  | 5MM       | 45CM   | 52155-25A1        | 52155-25A8  | 52155-25A9  | 52155-25A10  | 52155-25A17  | 52155-25A3    | 52155-25A4  |
| DBL. CUP FUNDUS MAXI GRASPER 16MM TIP<br>    | 5MM       | 24CM   | 52224-26A1        | 52224-26A8  | 52224-26A9  | 52224-26A10  | 52224-26A17  | 52224-26A3    | 52224-26A4  |
|  | 5MM       | 33CM   | 52255-26A1        | 52255-26A8  | 52255-26A9  | 52255-26A10  | 52255-26A17  | 52255-26A3    | 52255-26A4  |
|  | 5MM       | 36CM   | 52236-26A1        | 52236-26A8  | 52236-26A9  | 52236-26A10  | 52236-26A17  | 52236-26A3    | 52236-26A4  |
|  | 5MM       | 45CM   | 52155-26A1        | 52155-26A8  | 52155-26A9  | 52155-26A10  | 52155-26A17  | 52155-26A3    | 52155-26A4  |
| FENESTRATED DBL. FUNDUS GRASPER 16MM TIP<br> | 5MM       | 24CM   | 52224-226A1       | 52224-226A8 | 52224-226A9 | 52224-226A10 | 52224-226A17 | 52224-226A3   | 52224-226A4 |
|  | 5MM       | 33CM   | 52255-226A1       | 52255-226A8 | 52255-226A9 | 52255-226A10 | 52255-226A17 | 52255-226A3   | 52255-226A4 |
|  | 5MM       | 36CM   | 52236-226A1       | 52236-226A8 | 52236-226A9 | 52236-226A10 | 52236-226A17 | 52236-226A3   | 52236-226A4 |
|  | 5MM       | 45CM   | 52155-226A1       | 52155-226A8 | 52155-226A9 | 52155-226A10 | 52155-226A17 | 52155-226A3   | 52155-226A4 |
| "MCKERNAN" STYLE FUNDUS GRASPER 16MM TIP<br> | 5MM       | 24CM   | 52224-126A1       | 52224-126A8 | 52224-126A9 | 52224-126A10 | 52224-126A17 | 52224-126A3   | 52224-126A4 |
|  | 5MM       | 33CM   | 52255-126A1       | 52255-126A8 | 52255-126A9 | 52255-126A10 | 52255-126A17 | 52255-126A3   | 52255-126A4 |
|  | 5MM       | 36CM   | 52236-126A1       | 52236-126A8 | 52236-126A9 | 52236-126A10 | 52236-126A17 | 52236-126A3   | 52236-126A4 |
|  | 5MM       | 45CM   | 52155-126A1       | 52155-126A8 | 52155-126A9 | 52155-126A10 | 52155-126A17 | 52155-126A3   | 52155-126A4 |





# 5MM DISSECTORS & GRASPERS



MADE IN THE USA

**STYLE A**  
**RIGID, ONE-PIECE INSTRUMENT**  
**WITH FLUSH PORT**



| TIP ID & LENGTH   | HANDLE ID |        | TYPE 1            | TYPE 8      | TYPE 9      | TYPE 10      | TYPE 17      | TYPE 3        | TYPE 4      |
|---|-----------|--------|-------------------|-------------|-------------|--------------|--------------|---------------|-------------|
|   | DIAMETER  | LENGTH |                   |             |             |              |              |               |             |
|   |           |        | INSULATED HANDLES |             |             |              |              | NON-INSULATED |             |
| <b>"WINER" STYLE</b><br><b>FUNDUS</b><br><b>GRASPER</b><br><b>16MM TIP</b><br>                      | 5MM       | 24CM   | 52224-326A1       | 52224-326A8 | 52224-326A9 | 52224-326A10 | 52224-326A17 | 52224-326A3   | 52224-326A4 |
|   | 5MM       | 33CM   | 52255-326A1       | 52255-326A8 | 52255-326A9 | 52255-326A10 | 52255-326A17 | 52255-326A3   | 52255-326A4 |
|   | 5MM       | 36CM   | 52236-326A1       | 52236-326A8 | 52236-326A9 | 52236-326A10 | 52236-326A17 | 52236-326A3   | 52236-326A4 |
|   | 5MM       | 45CM   | 52155-326A1       | 52155-326A8 | 52155-326A9 | 52155-326A10 | 52155-326A17 | 52155-326A3   | 52155-326A4 |
| <b>"JARIT STYLE"</b><br><b>GRASPING</b><br><b>FORCEPS DUAL</b><br><b>CUP</b><br><b>16MM TIP</b><br> | 5MM       | 24CM   | 52224-426A1       | 52224-426A8 | 52224-426A9 | 52224-426A10 | 52224-426A17 | 52224-426A3   | 52224-426A4 |
|   | 5MM       | 33CM   | 52255-426A1       | 52255-426A8 | 52255-426A9 | 52255-426A10 | 52255-426A17 | 52255-426A3   | 52255-426A4 |
|   | 5MM       | 36CM   | 52236-426A1       | 52236-426A8 | 52236-426A9 | 52236-426A10 | 52236-426A17 | 52236-426A3   | 52236-426A4 |
|   | 5MM       | 45CM   | 52155-426A1       | 52155-426A8 | 52155-426A9 | 52155-426A10 | 52155-426A17 | 52155-426A3   | 52155-426A4 |
| <b>ENDOCLINCH</b><br><b>FENESTRATED</b><br><b>GRASPER</b><br><b>20MM TIP</b><br>                    | 5MM       | 24CM   | 52224-27A1        | 52224-27A8  | 52224-27A9  | 52224-27A10  | 52224-27A17  | 52224-27A3    | 52224-27A4  |
|   | 5MM       | 33CM   | 52255-27A1        | 52255-27A8  | 52255-27A9  | 52255-27A10  | 52255-27A17  | 52255-27A3    | 52255-27A4  |
|   | 5MM       | 36CM   | 52236-27A1        | 52236-27A8  | 52236-27A9  | 52236-27A10  | 52236-27A17  | 52236-27A3    | 52236-27A4  |
|   | 5MM       | 45CM   | 52155-27A1        | 52155-27A8  | 52155-27A9  | 52155-27A10  | 52155-27A17  | 52155-27A3    | 52155-27A4  |
| <b>RETRO-FACING,</b><br><b>RAT TOOTH W/</b><br><b>CUP</b><br><b>10MM TIP</b><br>                    | 5MM       | 24CM   | 52224-28A1        | 52224-28A8  | 52224-28A9  | 52224-28A10  | 52224-28A17  | 52224-28A3    | 52224-28A4  |
|   | 5MM       | 33CM   | 52255-28A1        | 52255-28A8  | 52255-28A9  | 52255-28A10  | 52255-28A17  | 52255-28A3    | 52255-28A4  |
|   | 5MM       | 36CM   | 52236-28A1        | 52236-28A8  | 52236-28A9  | 52236-28A10  | 52236-28A17  | 52236-28A3    | 52236-28A4  |
|   | 5MM       | 45CM   | 52155-28A1        | 52155-28A8  | 52155-28A9  | 52155-28A10  | 52155-28A17  | 52155-28A3    | 52155-28A4  |
| <b>ALLIGATOR</b><br><b>GRASPER, RETRO</b><br><b>-FACING TEETH,</b><br><b>DA 10MM TIP</b><br>        | 5MM       | 24CM   | 52224-29A1        | 52224-29A8  | 52224-29A9  | 52224-29A10  | 52224-29A17  | 52224-29A3    | 52224-29A4  |
|   | 5MM       | 33CM   | 52255-29A1        | 52255-29A8  | 52255-29A9  | 52255-29A10  | 52255-29A17  | 52255-29A3    | 52255-29A4  |
|   | 5MM       | 36CM   | 52236-29A1        | 52236-29A8  | 52236-29A9  | 52236-29A10  | 52236-29A17  | 52236-29A3    | 52236-29A4  |
|   | 5MM       | 45CM   | 52155-29A1        | 52155-29A8  | 52155-29A9  | 52155-29A10  | 52155-29A17  | 52155-29A3    | 52155-29A4  |
| <b>ALLIGATOR</b><br><b>GRASPER, RETRO</b><br><b>-FACING TEETH,</b><br><b>DA 20MM TIP</b><br>        | 5MM       | 24CM   | 52224-129A1       | 52224-129A8 | 52224-129A9 | 52224-129A10 | 52224-129A17 | 52224-129A3   | 52224-129A4 |
|   | 5MM       | 33CM   | 52255-129A1       | 52255-129A8 | 52255-129A9 | 52255-129A10 | 52255-129A17 | 52255-129A3   | 52255-129A4 |
|   | 5MM       | 36CM   | 52236-129A1       | 52236-129A8 | 52236-129A9 | 52236-129A10 | 52236-129A17 | 52236-129A3   | 52236-129A4 |
|   | 5MM       | 45CM   | 52155-129A1       | 52155-129A8 | 52155-129A9 | 52155-129A10 | 52155-129A17 | 52155-129A3   | 52155-129A4 |
| <b>ALLIGATOR</b><br><b>GRASPER, RETRO</b><br><b>-FACING TEETH,</b><br><b>SA 10MM TIP</b><br>        | 5MM       | 24CM   | 52224-30A1        | 52224-30A8  | 52224-30A9  | 52224-30A10  | 52224-30A17  | 52224-30A3    | 52224-30A4  |
|   | 5MM       | 33CM   | 52255-30A1        | 52255-30A8  | 52255-30A9  | 52255-30A10  | 52255-30A17  | 52255-30A3    | 52255-30A4  |
|   | 5MM       | 36CM   | 52236-30A1        | 52236-30A8  | 52236-30A9  | 52236-30A10  | 52236-30A17  | 52236-30A3    | 52236-30A4  |
|   | 5MM       | 45CM   | 52155-30A1        | 52155-30A8  | 52155-30A9  | 52155-30A10  | 52155-30A17  | 52155-30A3    | 52155-30A4  |





# 5MM DISSECTORS & GRASPERS



MADE IN THE USA

**STYLE A**  
**RIGID, ONE-PIECE INSTRUMENT**  
**WITH FLUSH PORT**

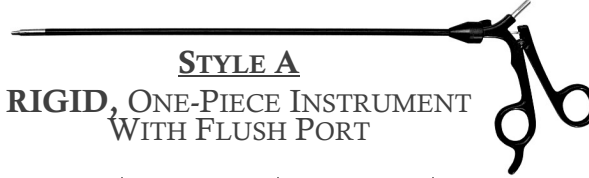

| TIP ID & LENGTH  | HANDLE ID |        | TYPE 1            | TYPE 8      | TYPE 9      | TYPE 10      | TYPE 17      | TYPE 3        | TYPE 4      |
|--|-----------|--------|-------------------|-------------|-------------|--------------|--------------|---------------|-------------|
|  | DIAMETER  | LENGTH |                   |             |             |              |              |               |             |
|  |           |        | INSULATED HANDLES |             |             |              |              | NON-INSULATED |             |
| CUP SHAPED GRASPER, W/ RETRO-FACING TEETH<br>10MM TIP<br>        | 5MM       | 24CM   | 52224-31A1        | 52224-31A8  | 52224-31A9  | 52224-31A10  | 52224-31A17  | 52224-31A3    | 52224-31A4  |
|  | 5MM       | 33CM   | 52255-31A1        | 52255-31A8  | 52255-31A9  | 52255-31A10  | 52255-31A17  | 52255-31A3    | 52255-31A4  |
|  | 5MM       | 36CM   | 52236-31A1        | 52236-31A8  | 52236-31A9  | 52236-31A10  | 52236-31A17  | 52236-31A3    | 52236-31A4  |
|  | 5MM       | 45CM   | 52155-31A1        | 52155-31A8  | 52155-31A9  | 52155-31A10  | 52155-31A17  | 52155-31A3    | 52155-31A4  |
| WAVE GRASPER, LONG BEVELED EDGE, DA<br>22MM TIP<br>              | 5MM       | 24CM   | 52224-32A1        | 52224-32A8  | 52224-32A9  | 52224-32A10  | 52224-32A17  | 52224-32A3    | 52224-32A4  |
|  | 5MM       | 33CM   | 52255-32A1        | 52255-32A8  | 52255-32A9  | 52255-32A10  | 52255-32A17  | 52255-32A3    | 52255-32A4  |
|  | 5MM       | 36CM   | 52236-32A1        | 52236-32A8  | 52236-32A9  | 52236-32A10  | 52236-32A17  | 52236-32A3    | 52236-32A4  |
|  | 5MM       | 45CM   | 52155-32A1        | 52155-32A8  | 52155-32A9  | 52155-32A10  | 52155-32A17  | 52155-32A3    | 52155-32A4  |
| WAVE GRASPER, LONG BEVELED EDGE, SA<br>22MM TIP<br>              | 5MM       | 24CM   | 52224-33A1        | 52224-33A8  | 52224-33A9  | 52224-33A10  | 52224-33A17  | 52224-33A3    | 52224-33A4  |
|  | 5MM       | 33CM   | 52255-33A1        | 52255-33A8  | 52255-33A9  | 52255-33A10  | 52255-33A17  | 52255-33A3    | 52255-33A4  |
|  | 5MM       | 36CM   | 52236-33A1        | 52236-33A8  | 52236-33A9  | 52236-33A10  | 52236-33A17  | 52236-33A3    | 52236-33A4  |
|  | 5MM       | 45CM   | 52155-33A1        | 52155-33A8  | 52155-33A9  | 52155-33A10  | 52155-33A17  | 52155-33A3    | 52155-33A4  |
| RETRACTION GRASPER, 2 X 3 TEETH, COBRA STYLE, DA<br>20MM TIP<br> | 5MM       | 24CM   | 52224-34A1        | 52224-34A8  | 52224-34A9  | 52224-34A10  | 52224-34A17  | 52224-34A3    | 52224-34A4  |
|  | 5MM       | 33CM   | 52255-34A1        | 52255-34A8  | 52255-34A9  | 52255-34A10  | 52255-34A17  | 52255-34A3    | 52255-34A4  |
|  | 5MM       | 36CM   | 52236-34A1        | 52236-34A8  | 52236-34A9  | 52236-34A10  | 52236-34A17  | 52236-34A3    | 52236-34A4  |
|  | 5MM       | 45CM   | 52155-34A1        | 52155-34A8  | 52155-34A9  | 52155-34A10  | 52155-34A17  | 52155-34A3    | 52155-34A4  |
| RETRACTION GRASPER, 2 X 3 TEETH, COBRA STYLE, SA<br>20MM TIP<br> | 5MM       | 24CM   | 52224-35A1        | 52224-35A8  | 52224-35A9  | 52224-35A10  | 52224-35A17  | 52224-35A3    | 52224-35A4  |
|  | 5MM       | 33CM   | 52255-35A1        | 52255-35A8  | 52255-35A9  | 52255-35A10  | 52255-35A17  | 52255-35A3    | 52255-35A4  |
|  | 5MM       | 36CM   | 52236-35A1        | 52236-35A8  | 52236-35A9  | 52236-35A10  | 52236-35A17  | 52236-35A3    | 52236-35A4  |
|  | 5MM       | 45CM   | 52155-35A1        | 52155-35A8  | 52155-35A9  | 52155-35A10  | 52155-35A17  | 52155-35A3    | 52155-35A4  |
| RETRACTION GRASPER, 2 X 3 TEETH, JARIT STYLE, DA<br>20MM TIP<br> | 5MM       | 24CM   | 52224-134A1       | 52224-134A8 | 52224-134A9 | 52224-134A10 | 52224-134A17 | 52224-134A3   | 52224-134A4 |
|  | 5MM       | 33CM   | 52255-134A1       | 52255-134A8 | 52255-134A9 | 52255-134A10 | 52255-134A17 | 52255-134A3   | 52255-134A4 |
|  | 5MM       | 36CM   | 52236-134A1       | 52236-134A8 | 52236-134A9 | 52236-134A10 | 52236-134A17 | 52236-134A3   | 52236-134A4 |
|  | 5MM       | 45CM   | 52155-134A1       | 52155-134A8 | 52155-134A9 | 52155-134A10 | 52155-134A17 | 52155-134A3   | 52155-134A4 |
| RETRACTION GRASPER, 2 X 3 TEETH, JARIT STYLE, SA<br>20MM TIP<br> | 5MM       | 24CM   | 52224-135A1       | 52224-135A8 | 52224-135A9 | 52224-135A10 | 52224-135A17 | 52224-135A3   | 52224-135A4 |
|  | 5MM       | 33CM   | 52255-135A1       | 52255-135A8 | 52255-135A9 | 52255-135A10 | 52255-135A17 | 52255-135A3   | 52255-135A4 |
|  | 5MM       | 36CM   | 52236-135A1       | 52236-135A8 | 52236-135A9 | 52236-135A10 | 52236-135A17 | 52236-135A3   | 52236-135A4 |
|  | 5MM       | 45CM   | 52155-135A1       | 52155-135A8 | 52155-135A9 | 52155-135A10 | 52155-135A17 | 52155-135A3   | 52155-135A4 |





# 5MM DISSECTORS & GRASPERS



MADE IN THE USA



| TIP ID & LENGTH  | HANDLE   |        | TYPE 1            | TYPE 8      | TYPE 9      | TYPE 10      | TYPE 17      | TYPE 3        | TYPE 4      |
|--|----------|--------|-------------------|-------------|-------------|--------------|--------------|---------------|-------------|
|  | DIAMETER | LENGTH |                   |             |             |              |              |               |             |
|  |          |        | INSULATED HANDLES |             |             |              |              | NON-INSULATED |             |
| CLAW GRASPER,<br>2 X 3 TEETH, SA<br>20MM TIP<br>                         | 5MM      | 24CM   | 52224-36A1        | 52224-36A8  | 52224-36A9  | 52224-36A10  | 52224-36A17  | 52224-36A3    | 52224-36A4  |
|  | 5MM      | 33CM   | 52255-36A1        | 52255-36A8  | 52255-36A9  | 52255-36A10  | 52255-36A17  | 52255-36A3    | 52255-36A4  |
|  | 5MM      | 36CM   | 52236-36A1        | 52236-36A8  | 52236-36A9  | 52236-36A10  | 52236-36A17  | 52236-36A3    | 52236-36A4  |
|  | 5MM      | 45CM   | 52155-36A1        | 52155-36A8  | 52155-36A9  | 52155-36A10  | 52155-36A17  | 52155-36A3    | 52155-36A4  |
| CLAW GRASPER,<br>2 X 3 TEETH,<br>W/ XTRA ROW<br>OF TEETH<br>20MM TIP<br> | 5MM      | 24CM   | 52224-136A1       | 52224-136A8 | 52224-136A9 | 52224-136A10 | 52224-136A17 | 52224-136A3   | 52224-136A4 |
|  | 5MM      | 33CM   | 52255-136A1       | 52255-136A8 | 52255-136A9 | 52255-136A10 | 52255-136A17 | 52255-136A3   | 52255-136A4 |
|  | 5MM      | 36CM   | 52236-136A1       | 52236-136A8 | 52236-136A9 | 52236-136A10 | 52236-136A17 | 52236-136A3   | 52236-136A4 |
|  | 5MM      | 45CM   | 52155-136A1       | 52155-136A8 | 52155-136A9 | 52155-136A10 | 52155-136A17 | 52155-136A3   | 52155-136A4 |
| ATRAUMATIC<br>FENESTRATED<br>GRASPER,<br>CURVED<br>16MM TIP<br>          | 5MM      | 24CM   | 52224-37A1        | 52224-37A8  | 52224-37A9  | 52224-37A10  | 52224-37A17  | 52224-37A3    | 52224-37A4  |
|  | 5MM      | 33CM   | 52255-37A1        | 52255-37A8  | 52255-37A9  | 52255-37A10  | 52255-37A17  | 52255-37A3    | 52255-37A4  |
|  | 5MM      | 36CM   | 52236-37A1        | 52236-37A8  | 52236-37A9  | 52236-37A10  | 52236-37A17  | 52236-37A3    | 52236-37A4  |
|  | 5MM      | 45CM   | 52155-37A1        | 52155-37A8  | 52155-37A9  | 52155-37A10  | 52155-37A17  | 52155-37A3    | 52155-37A4  |
| FENESTRATED<br>GRASPER<br>16MM TIP<br>                                   | 5MM      | 24CM   | 52224-38A1        | 52224-38A8  | 52224-38A9  | 52224-38A10  | 52224-38A17  | 52224-38A3    | 52224-38A4  |
|  | 5MM      | 33CM   | 52255-38A1        | 52255-38A8  | 52255-38A9  | 52255-38A10  | 52255-38A17  | 52255-38A3    | 52255-38A4  |
|  | 5MM      | 36CM   | 52236-38A1        | 52236-38A8  | 52236-38A9  | 52236-38A10  | 52236-38A17  | 52236-38A3    | 52236-38A4  |
|  | 5MM      | 45CM   | 52155-38A1        | 52155-38A8  | 52155-38A9  | 52155-38A10  | 52155-38A17  | 52155-38A3    | 52155-38A4  |
| FENESTRATED<br>GRASPER<br>20MM TIP<br>                                   | 5MM      | 24CM   | 52224-39A1        | 52224-39A8  | 52224-39A9  | 52224-39A10  | 52224-39A17  | 52224-39A3    | 52224-39A4  |
|  | 5MM      | 33CM   | 52255-39A1        | 52255-39A8  | 52255-39A9  | 52255-39A10  | 52255-39A17  | 52255-39A3    | 52255-39A4  |
|  | 5MM      | 36CM   | 52236-39A1        | 52236-39A8  | 52236-39A9  | 52236-39A10  | 52236-39A17  | 52236-39A3    | 52236-39A4  |
|  | 5MM      | 45CM   | 52155-39A1        | 52155-39A8  | 52155-39A9  | 52155-39A10  | 52155-39A17  | 52155-39A3    | 52155-39A4  |
| FENESTRATED<br>GRASPER<br>40MM TIP<br>                                   | 5MM      | 24CM   | 52224-40A1        | 52224-40A8  | 52224-40A9  | 52224-40A10  | 52224-40A17  | 52224-40A3    | 52224-40A4  |
|  | 5MM      | 33CM   | 52255-40A1        | 52255-40A8  | 52255-40A9  | 52255-40A10  | 52255-40A17  | 52255-40A3    | 52255-40A4  |
|  | 5MM      | 36CM   | 52236-40A1        | 52236-40A8  | 52236-40A9  | 52236-40A10  | 52236-40A17  | 52236-40A3    | 52236-40A4  |
|  | 5MM      | 45CM   | 52155-40A1        | 52155-40A8  | 52155-40A9  | 52155-40A10  | 52155-40A17  | 52155-40A3    | 52155-40A4  |
| FENESTRATED<br>GRASPER, SA<br>20MM TIP<br>                               | 5MM      | 24CM   | 52224-41A1        | 52224-41A8  | 52224-41A9  | 52224-41A10  | 52224-41A17  | 52224-41A3    | 52224-41A4  |
|  | 5MM      | 33CM   | 52255-41A1        | 52255-41A8  | 52255-41A9  | 52255-41A10  | 52255-41A17  | 52255-41A3    | 52255-41A4  |
|  | 5MM      | 36CM   | 52236-41A1        | 52236-41A8  | 52236-41A9  | 52236-41A10  | 52236-41A17  | 52236-41A3    | 52236-41A4  |
|  | 5MM      | 45CM   | 52155-41A1        | 52155-41A8  | 52155-41A9  | 52155-41A10  | 52155-41A17  | 52155-41A3    | 52155-41A4  |











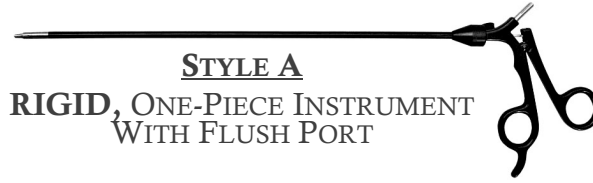







# 5MM DISSECTORS & GRASPERS

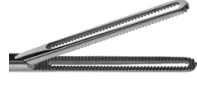

MADE IN THE USA



**STYLE A**  
**RIGID, ONE-PIECE INSTRUMENT**  
**WITH FLUSH PORT**

| TIP ID & LENGTH  | HANDLE ID |        | TYPE 1  | TYPE 8  | TYPE 9  | TYPE 10  | TYPE 17   | TYPE 3  | TYPE 4  |
|--|-----------|--------|---|---|---|--|---|---|---|
|  | DIAMETER  | LENGTH |  |  |  |  |  |  |  |
|  |           |        | INSULATED HANDLES   |   |   |  |   | NON-INSULATED   |   |
| <b>JOHAN FENESTRATED GRASPER, SA 45MM TIP</b><br>                      | 5MM       | 24CM   | 52224-42A1  | 52224-42A8  | 52224-42A9  | 52224-42A10  | 52224-42A17   | 52224-42A3  | 52224-42A4  |
|  | 5MM       | 33CM   | 52255-42A1  | 52255-42A8  | 52255-42A9  | 52255-42A10  | 52255-42A17   | 52255-42A3  | 52255-42A4  |
|  | 5MM       | 36CM   | 52236-42A1  | 52236-42A8  | 52236-42A9  | 52236-42A10  | 52236-42A17   | 52236-42A3  | 52236-42A4  |
|  | 5MM       | 45CM   | 52155-42A1  | 52155-42A8  | 52155-42A9  | 52155-42A10  | 52155-42A17   | 52155-42A3  | 52155-42A4  |
| <b>DOUBLE FENESTRATED GRASPER, 25MM TIP</b><br>                        | 5MM       | 24CM   | 52224-139A1   | 52224-139A8   | 52224-139A9   | 52224-139A10   | 52224-139A17  | 52224-139A3   | 52224-139A4   |
|  | 5MM       | 33CM   | 52255-139A1   | 52255-139A8   | 52255-139A9   | 52255-139A10   | 52255-139A17  | 52255-139A3   | 52255-139A4   |
|  | 5MM       | 36CM   | 52236-139A1   | 52236-139A8   | 52236-139A9   | 52236-139A10   | 52236-139A17  | 52236-139A3   | 52236-139A4   |
|  | 5MM       | 45CM   | 52155-139A1   | 52155-139A8   | 52155-139A9   | 52155-139A10   | 52155-139A17  | 52155-139A3   | 52155-139A4   |
| <b>KOCHER GRASPER, 1X2 TEETH, SA 15MM TIP</b><br>                    | 5MM       | 24CM   | 52224-43A1  | 52224-43A8  | 52224-43A9  | 52224-43A10  | 52224-43A17   | 52224-43A3  | 52224-43A4  |
|  | 5MM       | 33CM   | 52255-43A1  | 52255-43A8  | 52255-43A9  | 52255-43A10  | 52255-43A17   | 52255-43A3  | 52255-43A4  |
|  | 5MM       | 36CM   | 52236-43A1  | 52236-43A8  | 52236-43A9  | 52236-43A10  | 52236-43A17   | 52236-43A3  | 52236-43A4  |
|  | 5MM       | 45CM   | 52155-43A1  | 52155-43A8  | 52155-43A9  | 52155-43A10  | 52155-43A17   | 52155-43A3  | 52155-43A4  |
| <b>KOCHER GRASPER, 1X2 TEETH, DA (WECK TYPE) 15MM TIP</b><br>        | 5MM       | 24CM   | 52224-44A1  | 52224-44A8  | 52224-44A9  | 52224-44A10  | 52224-44A17   | 52224-44A3  | 52224-44A4  |
|  | 5MM       | 33CM   | 52255-44A1  | 52255-44A8  | 52255-44A9  | 52255-44A10  | 52255-44A17   | 52255-44A3  | 52255-44A4  |
|  | 5MM       | 36CM   | 52236-44A1  | 52236-44A8  | 52236-44A9  | 52236-44A10  | 52236-44A17   | 52236-44A3  | 52236-44A4  |
|  | 5MM       | 45CM   | 52155-44A1  | 52155-44A8  | 52155-44A9  | 52155-44A10  | 52155-44A17   | 52155-44A3  | 52155-44A4  |
| <b>SCHROEDER TENACULUM, SINGLE TOOTH ROUND TIP 25MM TIP</b><br>      | 5MM       | 24CM   | 52224-45A1  | 52224-45A8  | 52224-45A9  | 52224-45A10  | 52224-45A17   | 52224-45A3  | 52224-45A4  |
|  | 5MM       | 33CM   | 52255-45A1  | 52255-45A8  | 52255-45A9  | 52255-45A10  | 52255-45A17   | 52255-45A3  | 52255-45A4  |
|  | 5MM       | 36CM   | 52236-45A1  | 52236-45A8  | 52236-45A9  | 52236-45A10  | 52236-45A17   | 52236-45A3  | 52236-45A4  |
|  | 5MM       | 45CM   | 52155-45A1  | 52155-45A8  | 52155-45A9  | 52155-45A10  | 52155-45A17   | 52155-45A3  | 52155-45A4  |
| <b>SCHROEDER TENACULUM, SINGLE TOOTH, SQUARE TIP 25MM TIP</b><br>    | 5MM       | 24CM   | 52224-245A1   | 52224-245A8   | 52224-245A9   | 52224-245A10   | 52224-245A17  | 52224-245A3   | 52224-245A4   |
|  | 5MM       | 33CM   | 52255-245A1   | 52255-245A8   | 52255-245A9   | 52255-245A10   | 52255-245A17  | 52255-245A3   | 52255-245A4   |
|  | 5MM       | 36CM   | 52236-245A1   | 52236-245A8   | 52236-245A9   | 52236-245A10   | 52236-245A17  | 52236-245A3   | 52236-245A4   |
|  | 5MM       | 45CM   | 52155-245A1   | 52155-245A8   | 52155-245A9   | 52155-245A10   | 52155-245A17  | 52155-245A3   | 52155-245A4   |
| <b>SCHROEDER TEN. GRASPER, SINGLE TOOTH, XTRA TOOTH 25MM TIP</b><br> | 5MM       | 24CM   | 52224-94A1  | 52224-94A8  | 52224-94A9  | 52224-94A10  | 52224-94A17   | 52224-94A3  | 52224-94A4  |
|  | 5MM       | 33CM   | 52255-94A1  | 52255-94A8  | 52255-94A9  | 52255-94A10  | 52255-94A17   | 52255-94A3  | 52255-94A4  |
|  | 5MM       | 36CM   | 52236-94A1  | 52236-94A8  | 52236-94A9  | 52236-94A10  | 52236-94A17   | 52236-94A3  | 52236-94A4  |
|  | 5MM       | 45CM   | 52155-94A1  | 52155-94A8  | 52155-94A9  | 52155-94A10  | 52155-94A17   | 52155-94A3  | 52155-94A4  |





# 5MM DISSECTORS & GRASPERS



MADE IN THE USA

**STYLE A**  
**RIGID, ONE-PIECE INSTRUMENT**  
**WITH FLUSH PORT**



| TIP ID & LENGTH  | HANDLE   |        | TYPE 1            | TYPE 8      | TYPE 9      | TYPE 10      | TYPE 17      | TYPE 3        | TYPE 4      |
|--|----------|--------|-------------------|-------------|-------------|--------------|--------------|---------------|-------------|
|  | DIAMETER | LENGTH |                   |             |             |              |              |               |             |
|  |          |        | INSULATED HANDLES |             |             |              |              | NON-INSULATED |             |
| BLUNT ATRAUMATIC GRASPING FORCEPS, DA 14MM TIP<br>               | 5MM      | 24CM   | 52224-47A1        | 52224-47A8  | 52224-47A9  | 52224-47A10  | 52224-47A17  | 52224-47A3    | 52224-47A4  |
|  | 5MM      | 33CM   | 52255-47A1        | 52255-47A8  | 52255-47A9  | 52255-47A10  | 52255-47A17  | 52255-47A3    | 52255-47A4  |
|  | 5MM      | 36CM   | 52236-47A1        | 52236-47A8  | 52236-47A9  | 52236-47A10  | 52236-47A17  | 52236-47A3    | 52236-47A4  |
|  | 5MM      | 45CM   | 52155-47A1        | 52155-47A8  | 52155-47A9  | 52155-47A10  | 52155-47A17  | 52155-47A3    | 52155-47A4  |
| BLUNT ATRAUMATIC GRASPER W/ CROSS-SERRATED TIPS, DA 14MM TIP<br> | 5MM      | 24CM   | 52224-56A1        | 52224-56A8  | 52224-56A9  | 52224-56A10  | 52224-56A17  | 52224-56A3    | 52224-56A4  |
|  | 5MM      | 33CM   | 52255-56A1        | 52255-56A8  | 52255-56A9  | 52255-56A10  | 52255-56A17  | 52255-56A3    | 52255-56A4  |
|  | 5MM      | 36CM   | 52236-56A1        | 52236-56A8  | 52236-56A9  | 52236-56A10  | 52236-56A17  | 52236-56A3    | 52236-56A4  |
|  | 5MM      | 45CM   | 52155-56A1        | 52155-56A8  | 52155-56A9  | 52155-56A10  | 52155-56A17  | 52155-56A3    | 52155-56A4  |
| BULLET NOSE GRASPER TC, MICRO DIAMOND JAW 15MM TIP<br>           | 5MM      | 24CM   | 52224-48A1        | 52224-48A8  | 52224-48A9  | 52224-48A10  | 52224-48A17  | 52224-48A3    | 52224-48A4  |
|  | 5MM      | 33CM   | 52255-48A1        | 52255-48A8  | 52255-48A9  | 52255-48A10  | 52255-48A17  | 52255-48A3    | 52255-48A4  |
|  | 5MM      | 36CM   | 52236-48A1        | 52236-48A8  | 52236-48A9  | 52236-48A10  | 52236-48A17  | 52236-48A3    | 52236-48A4  |
|  | 5MM      | 45CM   | 52155-48A1        | 52155-48A8  | 52155-48A9  | 52155-48A10  | 52155-48A17  | 52155-48A3    | 52155-48A4  |
| BULLET NOSE GRASPER, TC, CROSS DIAMOND JAW 15MM TIP<br>          | 5MM      | 24CM   | 52224-49A1        | 52224-49A8  | 52224-49A9  | 52224-49A10  | 52224-49A17  | 52224-49A3    | 52224-49A4  |
|  | 5MM      | 33CM   | 52255-49A1        | 52255-49A8  | 52255-49A9  | 52255-49A10  | 52255-49A17  | 52255-49A3    | 52255-49A4  |
|  | 5MM      | 36CM   | 52236-49A1        | 52236-49A8  | 52236-49A9  | 52236-49A10  | 52236-49A17  | 52236-49A3    | 52236-49A4  |
|  | 5MM      | 45CM   | 52155-49A1        | 52155-49A8  | 52155-49A9  | 52155-49A10  | 52155-49A17  | 52155-49A3    | 52155-49A4  |
| LONG TAPERED GRASPER W/ ATRAUMATIC TEETH 20MM TIP<br>            | 5MM      | 24CM   | 52224-51A1        | 52224-51A8  | 52224-51A9  | 52224-51A10  | 52224-51A17  | 52224-51A3    | 52224-51A4  |
|  | 5MM      | 33CM   | 52255-51A1        | 52255-51A8  | 52255-51A9  | 52255-51A10  | 52255-51A17  | 52255-51A3    | 52255-51A4  |
|  | 5MM      | 36CM   | 52236-51A1        | 52236-51A8  | 52236-51A9  | 52236-51A10  | 52236-51A17  | 52236-51A3    | 52236-51A4  |
|  | 5MM      | 45CM   | 52155-51A1        | 52155-51A8  | 52155-51A9  | 52155-51A10  | 52155-51A17  | 52155-51A3    | 52155-51A4  |
| WAVE GRASPER, POINTED, SA 14MM TIP<br>                           | 5MM      | 24CM   | 52224-54A1        | 52224-54A8  | 52224-54A9  | 52224-54A10  | 52224-54A17  | 52224-54A3    | 52224-54A4  |
|  | 5MM      | 33CM   | 52255-54A1        | 52255-54A8  | 52255-54A9  | 52255-54A10  | 52255-54A17  | 52255-54A3    | 52255-54A4  |
|  | 5MM      | 36CM   | 52236-54A1        | 52236-54A8  | 52236-54A9  | 52236-54A10  | 52236-54A17  | 52236-54A3    | 52236-54A4  |
|  | 5MM      | 45CM   | 52155-54A1        | 52155-54A8  | 52155-54A9  | 52155-54A10  | 52155-54A17  | 52155-54A3    | 52155-54A4  |
| "ACCESS" TYPE, FENESTRATED GRASPER 20MM TIP<br>                  | 5MM      | 24CM   | 52224-191A1       | 52224-191A8 | 52224-191A9 | 52224-191A10 | 52224-191A17 | 52224-191A3   | 52224-191A4 |
|  | 5MM      | 33CM   | 52255-191A1       | 52255-191A8 | 52255-191A9 | 52255-191A10 | 52255-191A17 | 52255-191A3   | 52255-191A4 |
|  | 5MM      | 36CM   | 52236-191A1       | 52236-191A8 | 52236-191A9 | 52236-191A10 | 52236-191A17 | 52236-191A3   | 52236-191A4 |
|  | 5MM      | 45CM   | 52155-191A1       | 52155-191A8 | 52155-191A9 | 52155-191A10 | 52155-191A17 | 52155-191A3   | 52155-191A4 |





# 5MM DISSECTORS & GRASPERS



MADE IN THE USA



| TIP ID & LENGTH  | HANDLE ID |        | TYPE 1            | TYPE 8      | TYPE 9      | TYPE 10      | TYPE 17      | TYPE 3        | TYPE 4      |
|--|-----------|--------|-------------------|-------------|-------------|--------------|--------------|---------------|-------------|
|  | DIAMETER  | LENGTH |                   |             |             |              |              |               |             |
|  |           |        | INSULATED HANDLES |             |             |              |              | NON-INSULATED |             |
| "SOFT TOUCH" GRASPER, 22MM JAW, TEFLON INSERTS<br>22MM TIP<br> | 5MM       | 24CM   | 52224-144A1       | 52224-144A8 | 52224-144A9 | 52224-144A10 | 52224-144A17 | 52224-144A3   | 52224-144A4 |
|  | 5MM       | 33CM   | 52255-144A1       | 52255-144A8 | 52255-144A9 | 52255-144A10 | 52255-144A17 | 52255-144A3   | 52255-144A4 |
|  | 5MM       | 36CM   | 52236-144A1       | 52236-144A8 | 52236-144A9 | 52236-144A10 | 52236-144A17 | 52236-144A3   | 52236-144A4 |
|  | 5MM       | 45CM   | 52155-144A1       | 52155-144A8 | 52155-144A9 | 52155-144A10 | 52155-144A17 | 52155-144A3   | 52155-144A4 |
| "SOFT TOUCH" GRASPER, 40MM JAW, TEFLON INSERTS<br>40MM TIP<br> | 5MM       | 24CM   | 52224-145A1       | 52224-145A8 | 52224-145A9 | 52224-145A10 | 52224-145A17 | 52224-145A3   | 52224-145A4 |
|  | 5MM       | 33CM   | 52255-145A1       | 52255-145A8 | 52255-145A9 | 52255-145A10 | 52255-145A17 | 52255-145A3   | 52255-145A4 |
|  | 5MM       | 36CM   | 52236-145A1       | 52236-145A8 | 52236-145A9 | 52236-145A10 | 52236-145A17 | 52236-145A3   | 52236-145A4 |
|  | 5MM       | 45CM   | 52155-145A1       | 52155-145A8 | 52155-145A9 | 52155-145A10 | 52155-145A17 | 52155-145A3   | 52155-145A4 |
| TUBAL GRASPER, DA<br>10MM TIP<br>                              | 5MM       | 24CM   | 52224-156A1       | 52224-156A8 | 52224-156A9 | 52224-156A10 | 52224-156A17 | 52224-156A3   | 52224-156A4 |
|  | 5MM       | 33CM   | 52255-156A1       | 52255-156A8 | 52255-156A9 | 52255-156A10 | 52255-156A17 | 52255-156A3   | 52255-156A4 |
|  | 5MM       | 36CM   | 52236-156A1       | 52236-156A8 | 52236-156A9 | 52236-156A10 | 52236-156A17 | 52236-156A3   | 52236-156A4 |
|  | 5MM       | 45CM   | 52155-156A1       | 52155-156A8 | 52155-156A9 | 52155-156A10 | 52155-156A17 | 52155-156A3   | 52155-156A4 |
| "DAVOL" TYPE SCOOPED- JAW & GENTLY MASH TEETH<br>15MM TIP<br>  | 5MM       | 24CM   | 52224-90A1        | 52224-90A8  | 52224-90A9  | 52224-90A10  | 52224-90A17  | 52224-90A3    | 52224-90A4  |
|  | 5MM       | 33CM   | 52255-90A1        | 52255-90A8  | 52255-90A9  | 52255-90A10  | 52255-90A17  | 52255-90A3    | 52255-90A4  |
|  | 5MM       | 36CM   | 52236-90A1        | 52236-90A8  | 52236-90A9  | 52236-90A10  | 52236-90A17  | 52236-90A3    | 52236-90A4  |
|  | 5MM       | 45CM   | 52155-90A1        | 52155-90A8  | 52155-90A9  | 52155-90A10  | 52155-90A17  | 52155-90A3    | 52155-90A4  |
| "DAVOL" TYPE, SCOOPED- JAW & 2 X 3 FRONT TEETH<br>15MM TIP<br> | 5MM       | 24CM   | 52224-190A1       | 52224-190A8 | 52224-190A9 | 52224-190A10 | 52224-190A17 | 52224-190A3   | 52224-190A4 |
|  | 5MM       | 33CM   | 52255-190A1       | 52255-190A8 | 52255-190A9 | 52255-190A10 | 52255-190A17 | 52255-190A3   | 52255-190A4 |
|  | 5MM       | 36CM   | 52236-190A1       | 52236-190A8 | 52236-190A9 | 52236-190A10 | 52236-190A17 | 52236-190A3   | 52236-190A4 |
|  | 5MM       | 45CM   | 52155-190A1       | 52155-190A8 | 52155-190A9 | 52155-190A10 | 52155-190A17 | 52155-190A3   | 52155-190A4 |
| DEBAKEY GRASPER, SA<br>22MM TIP<br>                            | 5MM       | 24CM   | 52224-122A1       | 52224-122A8 | 52224-122A9 | 52224-122A10 | 52224-122A17 | 52224-122A3   | 52224-122A4 |
|  | 5MM       | 33CM   | 52255-122A1       | 52255-122A8 | 52255-122A9 | 52255-122A10 | 52255-122A17 | 52255-122A3   | 52255-122A4 |
|  | 5MM       | 36CM   | 52236-122A1       | 52236-122A8 | 52236-122A9 | 52236-122A10 | 52236-122A17 | 52236-122A3   | 52236-122A4 |
|  | 5MM       | 45CM   | 52155-122A1       | 52155-122A8 | 52155-122A9 | 52155-122A10 | 52155-122A17 | 52155-122A3   | 52155-122A4 |





# 5MM SCISSOR & BIOPSY



MADE IN THE USA



| TIP ID & LENGTH   | HANDLE            |        | TYPE 1      | TYPE 5      | TYPE 9      | TYPE 17       | TYPE 23      | TYPE 3      | TYPE 16      |
|---|-------------------|--------|-------------|-------------|-------------|---------------|--------------|-------------|--------------|
|   | DIAMETER          | LENGTH |             |             |             |               |              |             |              |
|   | INSULATED HANDLES |        |             |             |             | NON-INSULATED |              |             |              |
| <b>HOOKE SCISSORS, SA</b><br><b>10MM TIP</b><br>                          | 5MM               | 24CM   | 52224-60A1  | 52224-60A8  | 52224-60A9  | 52224-60A17   | 52224-60A23  | 52224-60A3  | 52224-60A16  |
|   | 5MM               | 33CM   | 52255-60A1  | 52255-60A8  | 52255-60A9  | 52255-60A17   | 52255-60A23  | 52255-60A3  | 52255-60A16  |
|   | 5MM               | 36CM   | 52236-60A1  | 52236-60A8  | 52236-60A9  | 52236-60A17   | 52236-60A23  | 52236-60A3  | 52236-60A16  |
|   | 5MM               | 45CM   | 52155-60A1  | 52155-60A8  | 52155-60A9  | 52155-60A17   | 52155-60A23  | 52155-60A3  | 52155-60A16  |
| <b>MICRO TIP SCISSORS, STRAIGHT, SA</b><br><b>5MM TIP</b><br>             | 5MM               | 24CM   | 52224-61A1  | 52224-61A8  | 52224-61A9  | 52224-61A17   | 52224-61A23  | 52224-61A3  | 52224-61A16  |
|   | 5MM               | 33CM   | 52255-61A1  | 52255-61A8  | 52255-61A9  | 52255-61A17   | 52255-61A23  | 52255-61A3  | 52255-61A16  |
|   | 5MM               | 36CM   | 52236-61A1  | 52236-61A8  | 52236-61A9  | 52236-61A17   | 52236-61A23  | 52236-61A3  | 52236-61A16  |
|   | 5MM               | 45CM   | 52155-61A1  | 52155-61A8  | 52155-61A9  | 52155-61A17   | 52155-61A23  | 52155-61A3  | 52155-61A16  |
| <b>MICRO TIP SCISSORS, CURVED, SA</b><br><b>5MM TIP</b><br>               | 5MM               | 24CM   | 52224-62A1  | 52224-62A8  | 52224-62A9  | 52224-62A17   | 52224-62A23  | 52224-62A3  | 52224-62A16  |
|   | 5MM               | 33CM   | 52255-62A1  | 52255-62A8  | 52255-62A9  | 52255-62A17   | 52255-62A23  | 52255-62A3  | 52255-62A16  |
|   | 5MM               | 36CM   | 52236-62A1  | 52236-62A8  | 52236-62A9  | 52236-62A17   | 52236-62A23  | 52236-62A3  | 52236-62A16  |
|   | 5MM               | 45CM   | 52155-62A1  | 52155-62A8  | 52155-62A9  | 52155-62A17   | 52155-62A23  | 52155-62A3  | 52155-62A16  |
| <b>METZENBAUM SCISSORS, STRAIGHT, LONG BLADE</b><br><b>20MM TIP</b><br>   | 5MM               | 24CM   | 52224-63A1  | 52224-63A8  | 52224-63A9  | 52224-63A17   | 52224-63A23  | 52224-63A3  | 52224-63A16  |
|   | 5MM               | 33CM   | 52255-63A1  | 52255-63A8  | 52255-63A9  | 52255-63A17   | 52255-63A23  | 52255-63A3  | 52255-63A16  |
|   | 5MM               | 36CM   | 52236-63A1  | 52236-63A8  | 52236-63A9  | 52236-63A17   | 52236-63A23  | 52236-63A3  | 52236-63A16  |
|   | 5MM               | 45CM   | 52155-63A1  | 52155-63A8  | 52155-63A9  | 52155-63A17   | 52155-63A23  | 52155-63A3  | 52155-63A16  |
| <b>METZENBAUM SCISSORS, STRAIGHT, SHORT BLADE</b><br><b>12MM TIP</b><br>  | 5MM               | 24CM   | 52224-64A1  | 52224-64A8  | 52224-64A9  | 52224-64A17   | 52224-64A23  | 52224-64A3  | 52224-64A16  |
|   | 5MM               | 33CM   | 52255-64A1  | 52255-64A8  | 52255-64A9  | 52255-64A17   | 52255-64A23  | 52255-64A3  | 52255-64A16  |
|   | 5MM               | 36CM   | 52236-64A1  | 52236-64A8  | 52236-64A9  | 52236-64A17   | 52236-64A23  | 52236-64A3  | 52236-64A16  |
|   | 5MM               | 45CM   | 52155-64A1  | 52155-64A8  | 52155-64A9  | 52155-64A17   | 52155-64A23  | 52155-64A3  | 52155-64A16  |
| <b>METZENBAUM SCISSORS, CURVED, LONG BLADE</b><br><b>16MM TIP</b><br>     | 5MM               | 24CM   | 52224-65A1  | 52224-65A8  | 52224-65A9  | 52224-65A17   | 52224-65A23  | 52224-65A3  | 52224-65A16  |
|   | 5MM               | 33CM   | 52255-65A1  | 52255-65A8  | 52255-65A9  | 52255-65A17   | 52255-65A23  | 52255-65A3  | 52255-65A16  |
|   | 5MM               | 36CM   | 52236-65A1  | 52236-65A8  | 52236-65A9  | 52236-65A17   | 52236-65A23  | 52236-65A3  | 52236-65A16  |
|   | 5MM               | 45CM   | 52155-65A1  | 52155-65A8  | 52155-65A9  | 52155-65A17   | 52155-65A23  | 52155-65A3  | 52155-65A16  |
| <b>METZENBAUM SCISSORS, WONDERCUT, CURVE BLADE</b><br><b>20MM TIP</b><br> | 5MM               | 24CM   | 52224-265A1 | 52224-265A8 | 52224-265A9 | 52224-265A17  | 52224-265A23 | 52224-265A3 | 52224-265A16 |
|   | 5MM               | 33CM   | 52255-265A1 | 52255-265A8 | 52255-265A9 | 52255-265A17  | 52255-265A23 | 52255-265A3 | 52255-265A16 |
|   | 5MM               | 36CM   | 52236-265A1 | 52236-265A8 | 52236-265A9 | 52236-265A17  | 52236-265A23 | 52236-265A3 | 52236-265A16 |
|   | 5MM               | 45CM   | 52155-265A1 | 52155-265A8 | 52155-265A9 | 52155-265A17  | 52155-265A23 | 52155-265A3 | 52155-265A16 |





# 5MM SCISSOR & BIOPSY



MADE IN THE USA



| TIP ID & LENGTH   | HANDLE   |        | TYPE 1            | TYPE 5      | TYPE 9      | TYPE 17      | TYPE 23      | TYPE 3        | TYPE 16      |
|---|----------|--------|-------------------|-------------|-------------|--------------|--------------|---------------|--------------|
|   | DIAMETER | LENGTH |                   |             |             |              |              |               |              |
|   |          |        | INSULATED HANDLES |             |             |              |              | NON-INSULATED |              |
| <b>METZENBAUM SCISSORS, CURVED, SHORT BLADE 12MM TIP</b><br>        | 5MM      | 24CM   | 52224-66A1        | 52224-66A8  | 52224-66A9  | 52224-66A17  | 52224-66A23  | 52224-66A3    | 52224-66A16  |
|   | 5MM      | 33CM   | 52255-66A1        | 52255-66A8  | 52255-66A9  | 52255-66A17  | 52255-66A23  | 52255-66A3    | 52255-66A16  |
|   | 5MM      | 36CM   | 52236-66A1        | 52236-66A8  | 52236-66A9  | 52236-66A17  | 52236-66A23  | 52236-66A3    | 52236-66A16  |
|   | 5MM      | 45CM   | 52155-66A1        | 52155-66A8  | 52155-66A9  | 52155-66A17  | 52155-66A23  | 52155-66A3    | 52155-66A16  |
| <b>PERITONEAL SCISSORS, SA 15MM TIP</b><br>                         | 5MM      | 24CM   | 52224-67A1        | 52224-67A8  | 52224-67A9  | 52224-67A17  | 52224-67A23  | 52224-67A3    | 52224-67A16  |
|   | 5MM      | 33CM   | 52255-67A1        | 52255-67A8  | 52255-67A9  | 52255-67A17  | 52255-67A23  | 52255-67A3    | 52255-67A16  |
|   | 5MM      | 36CM   | 52236-67A1        | 52236-67A8  | 52236-67A9  | 52236-67A17  | 52236-67A23  | 52236-67A3    | 52236-67A16  |
|   | 5MM      | 45CM   | 52155-67A1        | 52155-67A8  | 52155-67A9  | 52155-67A17  | 52155-67A23  | 52155-67A3    | 52155-67A16  |
| <b>BIOPSY SPOON FORCEPS W/ TOOTH 10MM TIP</b><br>                   | 5MM      | 24CM   | 52224-79A1        | 52224-79A8  | 52224-79A9  | 52224-79A17  | 52224-79A23  | 52224-79A3    | 52224-79A16  |
|   | 5MM      | 33CM   | 52255-79A1        | 52255-79A8  | 52255-79A9  | 52255-79A17  | 52255-79A23  | 52255-79A3    | 52255-79A16  |
|   | 5MM      | 36CM   | 52236-79A1        | 52236-79A8  | 52236-79A9  | 52236-79A17  | 52236-79A23  | 52236-79A3    | 52236-79A16  |
|   | 5MM      | 45CM   | 52155-79A1        | 52155-79A8  | 52155-79A9  | 52155-79A17  | 52155-79A23  | 52155-79A3    | 52155-79A16  |
| <b>BIOPSY SPOON FORCEPS, SHORT, SA 10MM TIP</b><br>                 | 5MM      | 24CM   | 52224-69A1        | 52224-69A8  | 52224-69A9  | 52224-69A17  | 52224-69A23  | 52224-69A3    | 52224-69A16  |
|   | 5MM      | 33CM   | 52255-69A1        | 52255-69A8  | 52255-69A9  | 52255-69A17  | 52255-69A23  | 52255-69A3    | 52255-69A16  |
|   | 5MM      | 36CM   | 52236-69A1        | 52236-69A8  | 52236-69A9  | 52236-69A17  | 52236-69A23  | 52236-69A3    | 52236-69A16  |
|   | 5MM      | 45CM   | 52155-69A1        | 52155-69A8  | 52155-69A9  | 52155-69A17  | 52155-69A23  | 52155-69A3    | 52155-69A16  |
| <b>POINTED BIOPSY SPOON FORCEPS, SA 10MM TIP</b><br>                | 5MM      | 24CM   | 52224-305A1       | 52224-305A8 | 52224-305A9 | 52224-305A17 | 52224-305A23 | 52224-305A3   | 52224-305A16 |
|   | 5MM      | 33CM   | 52255-305A1       | 52255-305A8 | 52255-305A9 | 52255-305A17 | 52255-305A23 | 52255-305A3   | 52255-305A16 |
|   | 5MM      | 36CM   | 52236-305A1       | 52236-305A8 | 52236-305A9 | 52236-305A17 | 52236-305A23 | 52236-305A3   | 52236-305A16 |
|   | 5MM      | 45CM   | 52155-305A1       | 52155-305A8 | 52155-305A9 | 52155-305A17 | 52155-305A23 | 52155-305A3   | 52155-305A16 |
| <b>BIOPSY SPOON FORCEPS, DA 10MM TIP</b><br>                        | 5MM      | 24CM   | 52224-70A1        | 52224-70A8  | 52224-70A9  | 52224-70A17  | 52224-70A23  | 52224-70A3    | 52224-70A16  |
|   | 5MM      | 33CM   | 52255-70A1        | 52255-70A8  | 52255-70A9  | 52255-70A17  | 52255-70A23  | 52255-70A3    | 52255-70A16  |
|   | 5MM      | 36CM   | 52236-70A1        | 52236-70A8  | 52236-70A9  | 52236-70A17  | 52236-70A23  | 52236-70A3    | 52236-70A16  |
|   | 5MM      | 45CM   | 52155-70A1        | 52155-70A8  | 52155-70A9  | 52155-70A17  | 52155-70A23  | 52155-70A3    | 52155-70A16  |
| <b>BIOPSY SPOON FORCEPS, W/ TOOTH (SEMM-TYPE), D/A 10MM TIP</b><br> | 5MM      | 24CM   | 52224-68A1        | 52224-68A8  | 52224-68A9  | 52224-68A17  | 52224-68A23  | 52224-68A3    | 52224-68A16  |
|   | 5MM      | 33CM   | 52255-68A1        | 52255-68A8  | 52255-68A9  | 52255-68A17  | 52255-68A23  | 52255-68A3    | 52255-68A16  |
|   | 5MM      | 36CM   | 52236-68A1        | 52236-68A8  | 52236-68A9  | 52236-68A17  | 52236-68A23  | 52236-68A3    | 52236-68A16  |
|   | 5MM      | 45CM   | 52155-68A1        | 52155-68A8  | 52155-68A9  | 52155-68A17  | 52155-68A23  | 52155-68A3    | 52155-68A16  |







# 5MM SCISSOR & BIOPSY

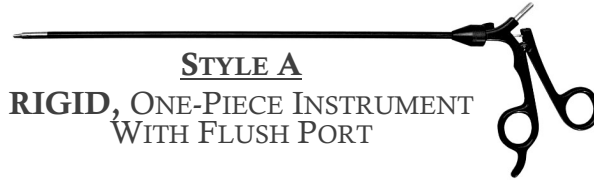

MADE IN THE USA

**STYLE A**  
**RIGID, ONE-PIECE INSTRUMENT**  
**WITH FLUSH PORT**



| TIP ID & LENGTH  | HANDLE ID |        | TYPE 1            | TYPE 5     | TYPE 9     | TYPE 17     | TYPE 23     | TYPE 3        | TYPE 16     |
|--|-----------|--------|-------------------|------------|------------|-------------|-------------|---------------|-------------|
|  | DIAMETER  | LENGTH |                   |            |            |             |             |               |             |
|  |           |        | INSULATED HANDLES |            |            |             |             | NON-INSULATED |             |
| BIOPSY PUNCH, SA<br>10MM TIP<br>               | 5MM       | 24CM   | 52224-71A1        | 52224-71A8 | 52224-71A9 | 52224-71A17 | 52224-71A23 | 52224-71A3    | 52224-71A16 |
|  | 5MM       | 33CM   | 52255-71A1        | 52255-71A8 | 52255-71A9 | 52255-71A17 | 52255-71A23 | 52255-71A3    | 52255-71A16 |
|  | 5MM       | 36CM   | 52236-71A1        | 52236-71A8 | 52236-71A9 | 52236-71A17 | 52236-71A23 | 52236-71A3    | 52236-71A16 |
|  | 5MM       | 45CM   | 52155-71A1        | 52155-71A8 | 52155-71A9 | 52155-71A17 | 52155-71A23 | 52155-71A3    | 52155-71A16 |
| BIOPSY PUNCH W/<br>TOOTH, SA<br>10MM TIP<br> | 5MM       | 24CM   | 52224-72A1        | 52224-72A8 | 52224-72A9 | 52224-72A17 | 52224-72A23 | 52224-72A3    | 52224-72A16 |
|  | 5MM       | 33CM   | 52255-72A1        | 52255-72A8 | 52255-72A9 | 52255-72A17 | 52255-72A23 | 52255-72A3    | 52255-72A16 |
|  | 5MM       | 36CM   | 52236-72A1        | 52236-72A8 | 52236-72A9 | 52236-72A17 | 52236-72A23 | 52236-72A3    | 52236-72A16 |
|  | 5MM       | 45CM   | 52155-72A1        | 52155-72A8 | 52155-72A9 | 52155-72A17 | 52155-72A23 | 52155-72A3    | 52155-72A16 |





# 10MM DISSECTORS & GRASPERS



MADE IN THE USA



| TIP ID & LENGTH  | HANDLE ID         |        | TYPE 1     | TYPE 8     | TYPE 9     | TYPE 10     | TYPE 17     | TYPE 3        | TYPE 4     |
|--|-------------------|--------|------------|------------|------------|-------------|-------------|---------------|------------|
|  | DIAMETER          | LENGTH |            |            |            |             |             |               |            |
|  | INSULATED HANDLES |        |            |            |            |             |             | NON-INSULATED |            |
| <b>MARYLAND DISSECTOR</b><br>18MM TIP<br>                        | 10MM              | 33CM   | 52102-06A1 | 52102-06A8 | 52102-06A9 | 52102-06A10 | 52102-06A17 | 52102-06A3    | 52102-06A4 |
|  | 10MM              | 36CM   | 52103-06A1 | 52103-06A8 | 52103-06A9 | 52103-06A10 | 52103-06A17 | 52103-06A3    | 52103-06A4 |
|  | 10MM              | 45CM   | 52101-06A1 | 52101-06A8 | 52101-06A9 | 52101-06A10 | 52101-06A17 | 52101-06A3    | 52101-06A4 |
| <b>RIGHT ANGLE MIXTER LONG</b><br>TEFLON INSERTS<br>22MM TIP<br> | 10MM              | 33CM   | 52102-07B1 | 52102-07B8 | 52102-07B9 | 52102-07B10 | 52102-07B17 | 52102-07B3    | 52102-07B4 |
|  | 10MM              | 36CM   | 52103-07B1 | 52103-07B8 | 52103-07B9 | 52103-07B10 | 52103-07B17 | 52103-07B3    | 52103-07B4 |
|  | 10MM              | 45CM   | 52101-07B1 | 52101-07B8 | 52101-07B9 | 52101-07B10 | 52101-07B17 | 52101-07B3    | 52101-07B4 |
| <b>RIGHT ANGLE MIXTER SHORT</b><br>12MM TIP<br>                  | 10MM              | 33CM   | 52102-59A1 | 52102-59A8 | 52102-59A9 | 52102-59A10 | 52102-59A17 | 52102-59A3    | 52102-59A4 |
|  | 10MM              | 36CM   | 52103-59A1 | 52103-59A8 | 52103-59A9 | 52103-59A10 | 52103-59A17 | 52103-59A3    | 52103-59A4 |
|  | 10MM              | 45CM   | 52101-59A1 | 52101-59A8 | 52101-59A9 | 52101-59A10 | 52101-59A17 | 52101-59A3    | 52101-59A4 |
| <b>45° ANGLED MIXTER</b><br>20MM TIP<br>                         | 10MM              | 33CM   | 52102-08A1 | 52102-08A8 | 52102-08A9 | 52102-08A10 | 52102-08A17 | 52102-08A3    | 52102-08A4 |
|  | 10MM              | 36CM   | 52103-08A1 | 52103-08A8 | 52103-08A9 | 52103-08A10 | 52103-08A17 | 52103-08A3    | 52103-08A4 |
|  | 10MM              | 45CM   | 52101-08A1 | 52101-08A8 | 52101-08A9 | 52101-08A10 | 52101-08A17 | 52101-08A3    | 52101-08A4 |
| <b>BABCOCK GRASPER</b><br>FENESTRATED TIP<br>30MM TIP<br>        | 10MM              | 33CM   | 52102-16A1 | 52102-16A8 | 52102-16A9 | 52102-16A10 | 52102-16A17 | 52102-16A3    | 52102-16A4 |
|  | 10MM              | 36CM   | 52103-16A1 | 52103-16A8 | 52103-16A9 | 52103-16A10 | 52103-16A17 | 52103-16A3    | 52103-16A4 |
|  | 10MM              | 45CM   | 52101-16A1 | 52101-16A8 | 52101-16A9 | 52101-16A10 | 52101-16A17 | 52101-16A3    | 52101-16A4 |
| <b>ALLIS GRASPER</b><br>STANDARD VERSION<br>30MM TIP<br>         | 10MM              | 33CM   | 52102-21A1 | 52102-21A8 | 52102-21A9 | 52102-21A10 | 52102-21A17 | 52102-21A3    | 52102-21A4 |
|  | 10MM              | 36CM   | 52103-21A1 | 52103-21A8 | 52103-21A9 | 52103-21A10 | 52103-21A17 | 52103-21A3    | 52103-21A4 |
|  | 10MM              | 45CM   | 52101-21A1 | 52101-21A8 | 52101-21A9 | 52101-21A10 | 52101-21A17 | 52101-21A3    | 52101-21A4 |
| <b>DEBAKEY GRASPER</b><br>40MM TIP<br>                           | 10MM              | 33CM   | 52102-22A1 | 52102-22A8 | 52102-22A9 | 52102-22A10 | 52102-22A17 | 52102-22A3    | 52102-22A4 |
|  | 10MM              | 36CM   | 52103-22A1 | 52103-22A8 | 52103-22A9 | 52103-22A10 | 52103-22A17 | 52103-22A3    | 52103-22A4 |
|  | 10MM              | 45CM   | 52101-22A1 | 52101-22A8 | 52101-22A9 | 52101-22A10 | 52101-22A17 | 52101-22A3    | 52101-22A4 |
| <b>DEBAKEY GRASPER</b><br>60MM TIP<br>                           | 10MM              | 33CM   | 52102-23A1 | 52102-23A8 | 52102-23A9 | 52102-23A10 | 52102-23A17 | 52102-23A3    | 52102-23A4 |
|  | 10MM              | 36CM   | 52103-23A1 | 52103-23A8 | 52103-23A9 | 52103-23A10 | 52103-23A17 | 52103-23A3    | 52103-23A4 |
|  | 10MM              | 45CM   | 52101-23A1 | 52101-23A8 | 52101-23A9 | 52101-23A10 | 52101-23A17 | 52101-23A3    | 52101-23A4 |
| <b>CLAW GRASPER,</b><br>2 X 3 TEETH, SA<br>20MM TIP<br>          | 10MM              | 33CM   | 52102-36A1 | 52102-36A8 | 52102-36A9 | 52102-36A10 | 52102-36A17 | 52102-36A3    | 52102-36A4 |
|  | 10MM              | 36CM   | 52103-36A1 | 52103-36A8 | 52103-36A9 | 52103-36A10 | 52103-36A17 | 52103-36A3    | 52103-36A4 |
|  | 10MM              | 45CM   | 52101-36A1 | 52101-36A8 | 52101-36A9 | 52101-36A10 | 52101-36A17 | 52101-36A3    | 52101-36A4 |

















# 10MM DISSECTORS & GRASPERS

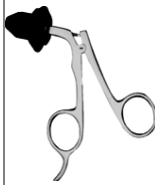

MADE IN THE USA



**STYLE A**  
**RIGID, ONE-PIECE INSTRUMENT**  
**WITH FLUSH PORT**

| TIP ID & LENGTH   | HANDLE ID |        | TYPE 1  | TYPE 8  | TYPE 9  | TYPE 10  | TYPE 17   | TYPE 3  | TYPE 4  |
|---|-----------|--------|---|---|---|--|---|---|---|
|   | DIAMETER  | LENGTH |  |  |  |  |  |  |  |
|   |           |        | INSULATED HANDLES   |   |   |  |   | NON-INSULATED   |   |
| SCHROEDER TEN. SINGLE TOOTH<br>25MM TIP<br>             | 10MM      | 33CM   | 52102-45A1  | 52102-45A8  | 52102-45A9  | 52102-45A10  | 52102-45A17   | 52102-45A3  | 52102-45A4  |
|   | 10MM      | 36CM   | 52103-45A1  | 52103-45A8  | 52103-45A9  | 52103-45A10  | 52103-45A17   | 52103-45A3  | 52103-45A4  |
|   | 10MM      | 45CM   | 52101-45A1  | 52101-45A8  | 52101-45A9  | 52101-45A10  | 52101-45A17   | 52101-45A3  | 52101-45A4  |
| US BABCOCK SPRING TENSION,<br>ATRAUMATIC 22MM TIP<br> | 10MM      | 33CM   | 52102-17A1  | 52102-17A8  | 52102-17A9  | 52102-17A10  | 52102-17A17   | 52102-17A3  | 52102-17A4  |
|   | 10MM      | 36CM   | 52103-17A1  | 52103-17A8  | 52103-17A9  | 52103-17A10  | 52103-17A17   | 52103-17A3  | 52103-17A4  |
|   | 10MM      | 45CM   | 52101-17A1  | 52101-17A8  | 52101-17A9  | 52101-17A10  | 52101-17A17   | 52101-17A3  | 52101-17A4  |
| DUVAL GRASPER, AXIAL SERRATIONS<br>40MM TIP<br>       | 10MM      | 33CM   | 52102-26A1  | 52102-26A8  | 52102-26A9  | 52102-26A10  | 52102-26A17   | 52102-26A3  | 52102-26A4  |
|   | 10MM      | 36CM   | 52103-26A1  | 52103-26A8  | 52103-26A9  | 52103-26A10  | 52103-26A17   | 52103-26A3  | 52103-26A4  |
|   | 10MM      | 45CM   | 52101-26A1  | 52101-26A8  | 52101-26A9  | 52101-26A10  | 52101-26A17   | 52101-26A3  | 52101-26A4  |
| STRONG ATRAUMATIC CLAMP,<br>STRAIGHT JAW 40MM TIP<br> | 10MM      | 33CM   | 52102-46A1  | 52102-46A8  | 52102-46A9  | 52102-46A10  | 52102-46A17   | 52102-46A3  | 52102-46A4  |
|   | 10MM      | 36CM   | 52103-46A1  | 52103-46A8  | 52103-46A9  | 52103-46A10  | 52103-46A17   | 52103-46A3  | 52103-46A4  |
|   | 10MM      | 45CM   | 52101-46A1  | 52101-46A8  | 52101-46A9  | 52101-46A10  | 52101-46A17   | 52101-46A3  | 52101-46A4  |
| STRONG ATRAUMATIC CLAMP,<br>CURVED JAW 40MM TIP<br>   | 10MM      | 33CM   | 52102-47A1  | 52102-47A8  | 52102-47A9  | 52102-47A10  | 52102-47A17   | 52102-47A3  | 52102-47A4  |
|   | 10MM      | 36CM   | 52103-47A1  | 52103-47A8  | 52103-47A9  | 52103-47A10  | 52103-47A17   | 52103-47A3  | 52103-47A4  |
|   | 10MM      | 45CM   | 52101-47A1  | 52101-47A8  | 52101-47A9  | 52101-47A10  | 52101-47A17   | 52101-47A3  | 52101-47A4  |
| ANVIL GRASPER TO GRASP & HOLD<br>ANVIL 10MM TIP<br>   | 10MM      | 33CM   | 52102-20A1  | 52102-20A8  | 52102-20A9  | 52102-20A10  | 52102-20A17   | 52102-20A3  | 52102-20A4  |
|   | 10MM      | 36CM   | 52103-20A1  | 52103-20A8  | 52103-20A9  | 52103-20A10  | 52103-20A17   | 52103-20A3  | 52103-20A4  |
|   | 10MM      | 45CM   | 52101-20A1  | 52101-20A8  | 52101-20A9  | 52101-20A10  | 52101-20A17   | 52101-20A3  | 52101-20A4  |















# 10MM DISSECTORS & GRASPERS

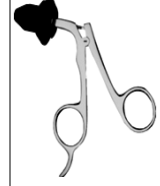

MADE IN THE USA

**STYLE A**  
**RIGID, ONE-PIECE INSTRUMENT**  
**WITH FLUSH PORT**



| TIP ID & LENGTH   | HANDLE ID |        | TYPE 1  | TYPE 5  | TYPE 9  | TYPE 17  | TYPE 23   | TYPE 3  | TYPE 16   |
|---|-----------|--------|---|---|---|--|---|---|---|
|   | DIAMETER  | LENGTH |  |  |  |  |  |  |  |
|   |           |        | INSULATED HANDLES   |   |   |  |   | UNINSULATED HANDLES   |   |
| <b>STRAIGHT SCISSORS, SA</b><br><b>20MM TIP</b><br>             | 10MM      | 33CM   | 52102-64A1  | 52102-64A8  | 52102-64A9  | 52102-64A10  | 52102-64A17   | 52102-64A3  | 52102-64A4  |
|   | 10MM      | 36CM   | 52103-64A1  | 52103-64A8  | 52103-64A9  | 52103-64A10  | 52103-64A17   | 52103-64A3  | 52103-64A4  |
|   | 10MM      | 45CM   | 52101-64A1  | 52101-64A8  | 52101-64A9  | 52101-64A10  | 52101-64A17   | 52101-64A3  | 52101-64A4  |
| <b>CURVED SCISSORS, DA</b><br><b>20MM TIP</b><br>             | 10MM      | 33CM   | 52102-66A1  | 52102-66A8  | 52102-66A9  | 52102-66A10  | 52102-66A17   | 52102-66A3  | 52102-66A4  |
|   | 10MM      | 36CM   | 52103-66A1  | 52103-66A8  | 52103-66A9  | 52103-66A10  | 52103-66A17   | 52103-66A3  | 52103-66A4  |
|   | 10MM      | 45CM   | 52101-66A1  | 52101-66A8  | 52101-66A9  | 52101-66A10  | 52101-66A17   | 52101-66A3  | 52101-66A4  |
| <b>BIOPSY SPOON FORCEPS, SHORT, SA</b><br><b>10MM TIP</b><br> | 10MM      | 33CM   | 52102-37A1  | 52102-37A8  | 52102-37A9  | 52102-37A10  | 52102-37A17   | 52102-37A3  | 52102-37A4  |
|   | 10MM      | 36CM   | 52103-37A1  | 52103-37A8  | 52103-37A9  | 52103-37A10  | 52103-37A17   | 52103-37A3  | 52103-37A4  |
|   | 10MM      | 45CM   | 52101-37A1  | 52101-37A8  | 52101-37A9  | 52101-37A10  | 52101-37A17   | 52101-37A3  | 52101-37A4  |
| <b>BIOPSY SPOON FORCEPS, LONG, SA</b><br><b>25MM TIP</b><br>  | 10MM      | 33CM   | 52102-38A1  | 52102-38A8  | 52102-38A9  | 52102-38A10  | 52102-38A17   | 52102-38A3  | 52102-38A4  |
|   | 10MM      | 36CM   | 52103-38A1  | 52103-38A8  | 52103-38A9  | 52103-38A10  | 52103-38A17   | 52103-38A3  | 52103-38A4  |
|   | 10MM      | 45CM   | 52101-38A1  | 52101-38A8  | 52101-38A9  | 52101-38A10  | 52101-38A17   | 52101-38A3  | 52101-38A4  |





# BASIN SERIES

## ONE PIECE ROTATABLE LAPAROSCOPIC INSTRUMENTS

THE BASIN SERIES 5MM & 10MM RIGID INSTRUMENTS ARE OUR CLASSIC **ONE-PIECE**, **ROTATABLE** INSTRUMENTS WITH FLUSH PORTS FOR EASY CLEANING. ALL ARE AVAILABLE WITH ANY OF OUR SELECTION OF HANDLES.

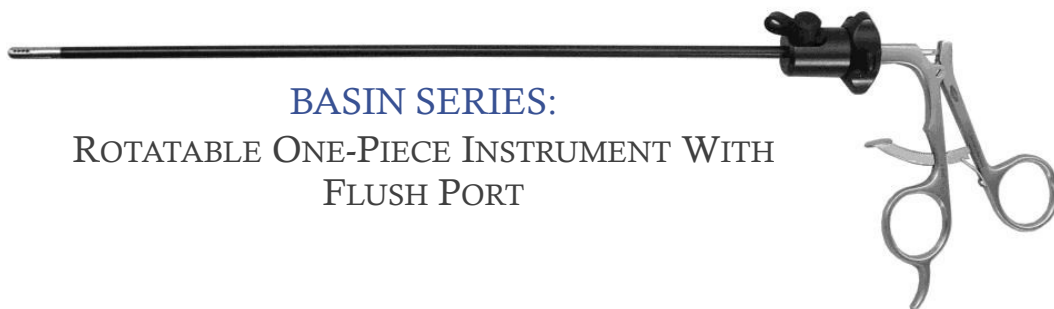

**BASIN SERIES:**  
ROTATABLE ONE-PIECE INSTRUMENT WITH  
FLUSH PORT



# HANDLES: INSULATED & CARBON FIBER



MADE IN THE USA

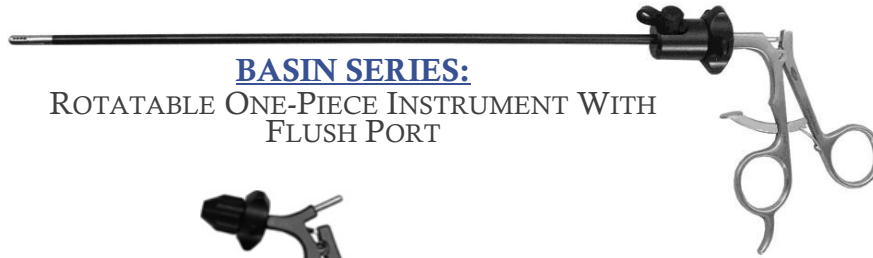

## BASIN SERIES:

ROTATABLE ONE-PIECE INSTRUMENT WITH FLUSH PORT

### **52555-40-01**

INSULATED STAINLESS STEEL W/  
RF POST  
(TYPE 1)



### **52555-40-02**

INSULATED STAINLESS STEEL  
W/ RF POST & RATCHET  
(TYPE 2)



### **52555-40-05**

INSULATED W/ RF POST &  
RATCHET  
(TYPE 5)



### **52555-40-06**

LIGHTWEIGHT CARBON FIBER W/  
RF POST & ON DEMAND ON/OFF  
RATCHET  
(TYPE 6)



### **52555-40-07**

LIGHTWEIGHT CARBON-FIBER W/  
RF POST, RATCHET / RATCHET  
DEFEATING  
(TYPE 7)



### **52555-40-08**

LIGHTWEIGHT CARBON-  
FIBER W/ RF POST, ON  
DEMAND FRENCH, ON/OFF  
RATCHET  
(TYPE 8)



### **52555-40-09**

LIGHTWEIGHT CARBON-FIBER W/ RF  
POST, W/ LARGE FINGER LOOPS  
(TYPE 9)



### **52555-40-10**

LIGHTWEIGHT  
CARBON-FIBER W/ RF POST,  
RATCHET / RATCHET DEFEATING  
W/ LARGE FINGER LOOPS  
(TYPE 10)



### **52555-40-14**

INSULATED STAINLESS STEEL  
LINVATEC-WECK STYLE W/  
LONG SHANKS  
(TYPE 14)



### **52555-40-17**

LIGHTWEIGHT THERMOS-PLASTIC  
W/ RF POST  
(TYPE 17)



### **52555-40-18**

LIGHTWEIGHT THERMOS-PLASTIC  
W/ RF POST, RATCHET /  
RATCHET DEFEATING  
(TYPE 18)



### **52555-40-23**

LIGHTWEIGHT THERMO-PLASTIC  
W/ RF POST, NON-RATCHET  
(TYPE 23)



### **52555-40-24**

LIGHTWEIGHT THERMO-  
PLASTIC W/ RF POST, W/  
RATCHET  
(TYPE 24)





# HANDLES: NON-INSULATED



MADE IN THE USA

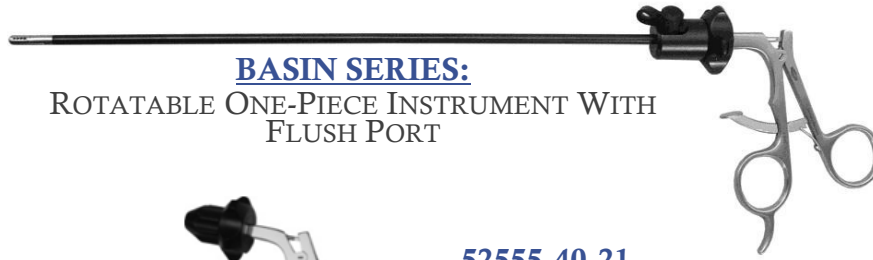

## BASIN SERIES:

ROTATABLE ONE-PIECE INSTRUMENT WITH FLUSH PORT

### **52555-40-03**

NON-INSULATED STAINLESS STEEL (TYPE 3)



### **52555-40-21**

STAINLESS STEEL AXIAL HANDLE V-SHAPED W/ SPREADING SPRING & THUMB RELEASE RATCHET (TYPE 21)



### **52555-40-04**

NON-INSULATED STAINLESS STEEL W/ RATCHET (TYPE 4)



### **52555-40-30**

STAINLESS STEEL AXIAL HANDLE V-SHAPED W/ SPREADING SPRING, NON-RATCHET (TYPE 30)



### **52555-40-11**

NON-INSULATED RING AXIAL HANDLE (TYPE 11)

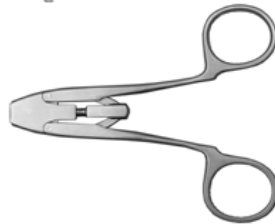

### **52555-40-19**

STAINLESS STEEL AXIAL HANDLE V-SHAPED, ANGLED DOWN W/ SPREADING SPRING & RATCHET (TYPE 19)



### **52555-40-12**

NON-INSULATED RING W/ AXIAL HANDLE W/ RATCHET (TYPE 12)



### **52555-40-31**

STAINLESS STEEL AXIAL HANDLE V-SHAPED, ANGLED DOWN W/ SPREADING SPRING, NON-RATCHET (TYPE 31)



### **52555-40-13**

STAINLESS STEEL AXIAL HANDLE W/ PRECISE ENGAGEMENT RATCHET (TYPE 13)



### **52555-40-26**

ALUMINUM AXIAL HANDLE SINGLE ACTION W/ RATCHET (TYPE 26)



### **52555-40-15**

NON-INSULATED STAINLESS STEEL LINVATEC-WECK STYLE W/ QUICK RELEASE RATCHET & LONG SHANKS (TYPE 15)



### **52555-40-28**

ALUMINUM AXIAL HANDLE SINGLE ACTION, NON-RATCHET (TYPE 28)



### **52555-40-16**

NON-INSULATED STAINLESS STEEL W/ SPRING ASSIST CLOSING (TYPE 16)



### **52555-40-27**

ALUMINUM AXIAL HANDLE, ANGLED DOWN, SINGLE ACTION W/ RATCHET (TYPE 27)



### **52003-70**

SILICONE RUBBER CAP W/ STRAP—10/pkg



### **52555-40-29**

ALUMINUM AXIAL HANDLE, ANGLED DOWN, SINGLE ACTION, NON-RATCHET (TYPE 13)













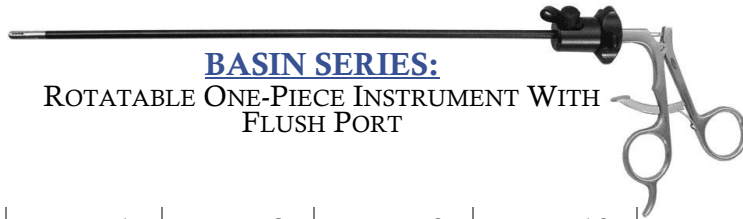





# 5MM DISSECTORS & GRASPERS



MADE IN THE USA

**BASIN SERIES:**  
ROTATABLE ONE-PIECE INSTRUMENT WITH  
FLUSH PORT



| TIP ID & LENGTH  | HANDLE   |        | TYPE 1  | TYPE 8  | TYPE 9  | TYPE 10  | TYPE 17   | TYPE 3  | TYPE 4  |
|--|----------|--------|---|---|---|--|---|---|---|
|  | DIAMETER | LENGTH |  |  |  |  |  |  |  |
|  |          |        | INSULATED HANDLES   |   |   |  | NON-INSULATED   |   |   |
| <b>MICRO REDDICK OLSEN</b><br>12MM TIP<br>               | 5MM      | 24CM   | 52224-01B1  | 52224-01B8  | 52224-01B9  | 52224-01B10  | 52224-01B17   | 52224-01B3  | 52224-01B4  |
|  | 5MM      | 33CM   | 52255-01B1  | 52255-01B8  | 52255-01B9  | 52255-01B10  | 52255-01B17   | 52255-01B3  | 52255-01B4  |
|  | 5MM      | 36CM   | 52236-01B1  | 52236-01B8  | 52236-01B9  | 52236-01B10  | 52236-01B17   | 52236-01B3  | 52236-01B4  |
|  | 5MM      | 45CM   | 52155-01B1  | 52155-01B8  | 52155-01B9  | 52155-01B10  | 52155-01B17   | 52155-01B3  | 52155-01B4  |
| <b>STANDARD GRASPER W/ SPOON</b><br>12MM TIP<br>         | 5MM      | 24CM   | 52224-02B1  | 52224-02B8  | 52224-02B9  | 52224-02B10  | 52224-02B17   | 52224-02B3  | 52224-02B4  |
|  | 5MM      | 33CM   | 52255-02B1  | 52255-02B8  | 52255-02B9  | 52255-02B10  | 52255-02B17   | 52255-02B3  | 52255-02B4  |
|  | 5MM      | 36CM   | 52236-02B1  | 52236-02B8  | 52236-02B9  | 52236-02B10  | 52236-02B17   | 52236-02B3  | 52236-02B4  |
|  | 5MM      | 45CM   | 52155-02B1  | 52155-02B8  | 52155-02B9  | 52155-02B10  | 52155-02B17   | 52155-02B3  | 52155-02B4  |
| <b>STANDARD GRASPER W/ SPOON, LONG</b><br>20MM TIP<br> | 5MM      | 24CM   | 52224-52B1  | 52224-52B8  | 52224-52B9  | 52224-52B10  | 52224-52B17   | 52224-52B3  | 52224-52B4  |
|  | 5MM      | 33CM   | 52255-52B1  | 52255-52B8  | 52255-52B9  | 52255-52B10  | 52255-52B17   | 52255-52B3  | 52255-52B4  |
|  | 5MM      | 36CM   | 52236-52B1  | 52236-52B8  | 52236-52B9  | 52236-52B10  | 52236-52B17   | 52236-52B3  | 52236-52B4  |
|  | 5MM      | 45CM   | 52155-52B1  | 52155-52B8  | 52155-52B9  | 52155-52B10  | 52155-52B17   | 52155-52B3  | 52155-52B4  |
| <b>STANDARD GRASPER</b><br>12MM TIP<br>               | 5MM      | 24CM   | 52224-03B1  | 52224-03B8  | 52224-03B9  | 52224-03B10  | 52224-03B17   | 52224-03B3  | 52224-03B4  |
|  | 5MM      | 33CM   | 52255-03B1  | 52255-03B8  | 52255-03B9  | 52255-03B10  | 52255-03B17   | 52255-03B3  | 52255-03B4  |
|  | 5MM      | 36CM   | 52236-03B1  | 52236-03B8  | 52236-03B9  | 52236-03B10  | 52236-03B17   | 52236-03B3  | 52236-03B4  |
|  | 5MM      | 45CM   | 52155-03B1  | 52155-03B8  | 52155-03B9  | 52155-03B10  | 52155-03B17   | 52155-03B3  | 52155-03B4  |
| <b>BULLET NOSE GRASPER W/ SPOON</b><br>12MM TIP<br>   | 5MM      | 24CM   | 52224-04B1  | 52224-04B8  | 52224-04B9  | 52224-04B10  | 52224-04B17   | 52224-04B3  | 52224-04B4  |
|  | 5MM      | 33CM   | 52255-04B1  | 52255-04B8  | 52255-04B9  | 52255-04B10  | 52255-04B17   | 52255-04B3  | 52255-04B4  |
|  | 5MM      | 36CM   | 52236-04B1  | 52236-04B8  | 52236-04B9  | 52236-04B10  | 52236-04B17   | 52236-04B3  | 52236-04B4  |
|  | 5MM      | 45CM   | 52155-04B1  | 52155-04B8  | 52155-04B9  | 52155-04B10  | 52155-04B17   | 52155-04B3  | 52155-04B4  |
| <b>TAPERED DOLPHIN-NOSE</b><br>15MM TIP<br>            | 5MM      | 24CM   | 52224-05B1  | 52224-05B8  | 52224-05B9  | 52224-05B10  | 52224-05B17   | 52224-05B3  | 52224-05B4  |
|  | 5MM      | 33CM   | 52255-05B1  | 52255-05B8  | 52255-05B9  | 52255-05B10  | 52255-05B17   | 52255-05B3  | 52255-05B4  |
|  | 5MM      | 36CM   | 52236-05B1  | 52236-05B8  | 52236-05B9  | 52236-05B10  | 52236-05B17   | 52236-05B3  | 52236-05B4  |
|  | 5MM      | 45CM   | 52155-05B1  | 52155-05B8  | 52155-05B9  | 52155-05B10  | 52155-05B17   | 52155-05B3  | 52155-05B4  |
| <b>TAPERED DOLPHIN-NOSE W/ SPOON</b><br>15MM TIP<br>   | 5MM      | 24CM   | 52224-105B1   | 52224-105B8   | 52224-105B9   | 52224-105B10   | 52224-105B17  | 52224-105B3   | 52224-105B4   |
|  | 5MM      | 33CM   | 52255-105B1   | 52255-105B8   | 52255-105B9   | 52255-105B10   | 52255-105B17  | 52255-105B3   | 52255-105B4   |
|  | 5MM      | 36CM   | 52236-105B1   | 52236-105B8   | 52236-105B9   | 52236-105B10   | 52236-105B17  | 52236-105B3   | 52236-105B4   |
|  | 5MM      | 45CM   | 52155-105B1   | 52155-105B8   | 52155-105B9   | 52155-105B10   | 52155-105B17  | 52155-105B3   | 52155-105B4   |





# 5MM DISSECTORS & GRASPERS



MADE IN THE USA

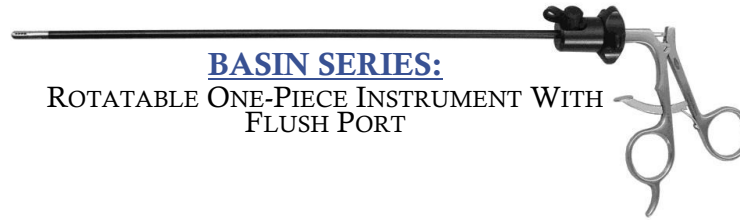

## BASIN SERIES:

ROTATABLE ONE-PIECE INSTRUMENT WITH FLUSH PORT

| TIP ID & LENGTH                                    | HANDLE   |        | TYPE 1            | TYPE 8      | TYPE 9      | TYPE 10      | TYPE 17      | TYPE 3        | TYPE 4      |
|--|----------|--------|-------------------|-------------|-------------|--------------|--------------|---------------|-------------|
|  | DIAMETER | LENGTH |                   |             |             |              |              |               |             |
|  |          |        | INSULATED HANDLES |             |             |              |              | NON-INSULATED |             |
| TAPERED DOLPHIN-NOSE W/ LONG SPOON<br>22MM TIP<br> | 5MM      | 24CM   | 52224-205B1       | 52224-205B8 | 52224-205B9 | 52224-205B10 | 52224-205B17 | 52224-205B3   | 52224-205B4 |
|  | 5MM      | 33CM   | 52255-205B1       | 52255-205B8 | 52255-205B9 | 52255-205B10 | 52255-205B17 | 52255-205B3   | 52255-205B4 |
|  | 5MM      | 36CM   | 52236-205B1       | 52236-205B8 | 52236-205B9 | 52236-205B10 | 52236-205B17 | 52236-205B3   | 52236-205B4 |
|  | 5MM      | 45CM   | 52155-205B1       | 52155-205B8 | 52155-205B9 | 52155-205B10 | 52155-205B17 | 52155-205B3   | 52155-205B4 |
| MARYLAND DISSECTOR<br>18MM TIP<br>                 | 5MM      | 24CM   | 52224-06B1        | 52224-06B8  | 52224-06B9  | 52224-06B10  | 52224-06B17  | 52224-06B3    | 52224-06B4  |
|  | 5MM      | 33CM   | 52255-06B1        | 52255-06B8  | 52255-06B9  | 52255-06B10  | 52255-06B17  | 52255-06B3    | 52255-06B4  |
|  | 5MM      | 36CM   | 52236-06B1        | 52236-06B8  | 52236-06B9  | 52236-06B10  | 52236-06B17  | 52236-06B3    | 52236-06B4  |
|  | 5MM      | 45CM   | 52155-06B1        | 52155-06B8  | 52155-06B9  | 52155-06B10  | 52155-06B17  | 52155-06B3    | 52155-06B4  |
| TAPERED MARYLAND DISSECTOR<br>18MM TIP<br>         | 5MM      | 24CM   | 52224-106B1       | 52224-106B8 | 52224-106B9 | 52224-106B10 | 52224-106B17 | 52224-106B3   | 52224-106B4 |
|  | 5MM      | 33CM   | 52255-106B1       | 52255-106B8 | 52255-106B9 | 52255-106B10 | 52255-106B17 | 52255-106B3   | 52255-106B4 |
|  | 5MM      | 36CM   | 52236-106B1       | 52236-106B8 | 52236-106B9 | 52236-106B10 | 52236-106B17 | 52236-106B3   | 52236-106B4 |
|  | 5MM      | 45CM   | 52155-106B1       | 52155-106B8 | 52155-106B9 | 52155-106B10 | 52155-106B17 | 52155-106B3   | 52155-106B4 |
| SHORT MARYLAND DISSECTOR<br>15MM TIP<br>           | 5MM      | 24CM   | 52224-206B1       | 52224-206B8 | 52224-206B9 | 52224-206B10 | 52224-206B17 | 52224-206B3   | 52224-206B4 |
|  | 5MM      | 33CM   | 52255-206B1       | 52255-206B8 | 52255-206B9 | 52255-206B10 | 52255-206B17 | 52255-206B3   | 52255-206B4 |
|  | 5MM      | 36CM   | 52236-206B1       | 52236-206B8 | 52236-206B9 | 52236-206B10 | 52236-206B17 | 52236-206B3   | 52236-206B4 |
|  | 5MM      | 45CM   | 52155-206B1       | 52155-206B8 | 52155-206B9 | 52155-206B10 | 52155-206B17 | 52155-206B3   | 52155-206B4 |
| RIGHT ANGLE MIXTER LONG<br>22MM TIP<br>            | 5MM      | 24CM   | 52224-07B1        | 52224-07B8  | 52224-07B9  | 52224-07B10  | 52224-07B17  | 52224-07B3    | 52224-07B4  |
|  | 5MM      | 33CM   | 52255-07B1        | 52255-07B8  | 52255-07B9  | 52255-07B10  | 52255-07B17  | 52255-07B3    | 52255-07B4  |
|  | 5MM      | 36CM   | 52236-07B1        | 52236-07B8  | 52236-07B9  | 52236-07B10  | 52236-07B17  | 52236-07B3    | 52236-07B4  |
|  | 5MM      | 45CM   | 52155-07B1        | 52155-07B8  | 52155-07B9  | 52155-07B10  | 52155-07B17  | 52155-07B3    | 52155-07B4  |
| RIGHT ANGLE MIXTER, SHORT<br>12MM TIP<br>          | 5MM      | 24CM   | 52224-59B1        | 52224-59B8  | 52224-59B9  | 52224-59B10  | 52224-59B17  | 52224-59B3    | 52224-59B4  |
|  | 5MM      | 33CM   | 52255-59B1        | 52255-59B8  | 52255-59B9  | 52255-59B10  | 52255-59B17  | 52255-59B3    | 52255-59B4  |
|  | 5MM      | 36CM   | 52236-59B1        | 52236-59B8  | 52236-59B9  | 52236-59B10  | 52236-59B17  | 52236-59B3    | 52236-59B4  |
|  | 5MM      | 45CM   | 52155-59B1        | 52155-59B8  | 52155-59B9  | 52155-59B10  | 52155-59B17  | 52155-59B3    | 52155-59B4  |
| 45° ANGLED MIXTER<br>20MM TIP<br>                  | 5MM      | 24CM   | 52224-08B1        | 52224-08B8  | 52224-08B9  | 52224-08B10  | 52224-08B17  | 52224-08B3    | 52224-08B4  |
|  | 5MM      | 33CM   | 52255-08B1        | 52255-08B8  | 52255-08B9  | 52255-08B10  | 52255-08B17  | 52255-08B3    | 52255-08B4  |
|  | 5MM      | 36CM   | 52236-08B1        | 52236-08B8  | 52236-08B9  | 52236-08B10  | 52236-08B17  | 52236-08B3    | 52236-08B4  |
|  | 5MM      | 45CM   | 52155-08B1        | 52155-08B8  | 52155-08B9  | 52155-08B10  | 52155-08B17  | 52155-08B3    | 52155-08B4  |





# 5MM DISSECTORS & GRASPERS



MADE IN THE USA

**BASIN SERIES:**  
ROTATABLE ONE-PIECE INSTRUMENT WITH  
FLUSH PORT

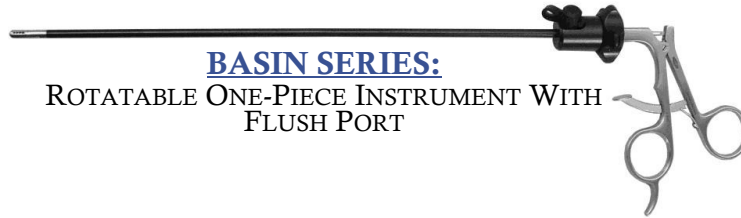

| TIP ID & LENGTH   | HANDLE   |        | TYPE 1            | TYPE 8      | TYPE 9      | TYPE 10      | TYPE 17       | TYPE 3      | TYPE 4      |
|---|----------|--------|-------------------|-------------|-------------|--------------|---------------|-------------|-------------|
|   | DIAMETER | LENGTH |                   |             |             |              |               |             |             |
|   |          |        | INSULATED HANDLES |             |             |              | NON-INSULATED |             |             |
| <b>DUCKBILL GRASPER</b><br>12MM TIP<br>                     | 5MM      | 24CM   | 52224-09B1        | 52224-09B8  | 52224-09B9  | 52224-09B10  | 52224-09B17   | 52224-09B3  | 52224-09B4  |
|   | 5MM      | 33CM   | 52255-09B1        | 52255-09B8  | 52255-09B9  | 52255-09B10  | 52255-09B17   | 52255-09B3  | 52255-09B4  |
|   | 5MM      | 36CM   | 52236-09B1        | 52236-09B8  | 52236-09B9  | 52236-09B10  | 52236-09B17   | 52236-09B3  | 52236-09B4  |
|   | 5MM      | 45CM   | 52155-09B1        | 52155-09B8  | 52155-09B9  | 52155-09B10  | 52155-09B17   | 52155-09B3  | 52155-09B4  |
| <b>NEEDLE-NOSE GRASPER</b><br>20MM TIP<br>                  | 5MM      | 24CM   | 52224-10B1        | 52224-10B8  | 52224-10B9  | 52224-10B10  | 52224-10B17   | 52224-10B3  | 52224-10B4  |
|   | 5MM      | 33CM   | 52255-10B1        | 52255-10B8  | 52255-10B9  | 52255-10B10  | 52255-10B17   | 52255-10B3  | 52255-10B4  |
|   | 5MM      | 36CM   | 52236-10B1        | 52236-10B8  | 52236-10B9  | 52236-10B10  | 52236-10B17   | 52236-10B3  | 52236-10B4  |
|   | 5MM      | 45CM   | 52155-10B1        | 52155-10B8  | 52155-10B9  | 52155-10B10  | 52155-10B17   | 52155-10B3  | 52155-10B4  |
| <b>KELLY GRASPER</b><br>14MM TIP<br>                        | 5MM      | 24CM   | 52224-11B1        | 52224-11B8  | 52224-11B9  | 52224-11B10  | 52224-11B17   | 52224-11B3  | 52224-11B4  |
|   | 5MM      | 33CM   | 52255-11B1        | 52255-11B8  | 52255-11B9  | 52255-11B10  | 52255-11B17   | 52255-11B3  | 52255-11B4  |
|   | 5MM      | 36CM   | 52236-11B1        | 52236-11B8  | 52236-11B9  | 52236-11B10  | 52236-11B17   | 52236-11B3  | 52236-11B4  |
|   | 5MM      | 45CM   | 52155-11B1        | 52155-11B8  | 52155-11B9  | 52155-11B10  | 52155-11B17   | 52155-11B3  | 52155-11B4  |
| <b>RIGHT ANGLE, LONG REACH GRASPER</b><br>22MM TIP<br>      | 5MM      | 24CM   | 52224-53B1        | 52224-53B8  | 52224-53B9  | 52224-53B10  | 52224-53B17   | 52224-53B3  | 52224-53B4  |
|   | 5MM      | 33CM   | 52255-53B1        | 52255-53B8  | 52255-53B9  | 52255-53B10  | 52255-53B17   | 52255-53B3  | 52255-53B4  |
|   | 5MM      | 36CM   | 52236-53B1        | 52236-53B8  | 52236-53B9  | 52236-53B10  | 52236-53B17   | 52236-53B3  | 52236-53B4  |
|   | 5MM      | 45CM   | 52155-53B1        | 52155-53B8  | 52155-53B9  | 52155-53B10  | 52155-53B17   | 52155-53B3  | 52155-53B4  |
| <b>PETELIN DISSECTOR, 60° ANGLE, SA</b><br>10MM TIP<br>     | 5MM      | 24CM   | 52224-12B1        | 52224-12B8  | 52224-12B9  | 52224-12B10  | 52224-12B17   | 52224-12B3  | 52224-12B4  |
|   | 5MM      | 33CM   | 52255-12B1        | 52255-12B8  | 52255-12B9  | 52255-12B10  | 52255-12B17   | 52255-12B3  | 52255-12B4  |
|   | 5MM      | 36CM   | 52236-12B1        | 52236-12B8  | 52236-12B9  | 52236-12B10  | 52236-12B17   | 52236-12B3  | 52236-12B4  |
|   | 5MM      | 45CM   | 52155-12B1        | 52155-12B8  | 52155-12B9  | 52155-12B10  | 52155-12B17   | 52155-12B3  | 52155-12B4  |
| <b>PETELIN DISSECTOR, 30° ANGLE, SA</b><br>10MM TIP<br>     | 5MM      | 24CM   | 52224-13B1        | 52224-13B8  | 52224-13B9  | 52224-13B10  | 52224-13B17   | 52224-13B3  | 52224-13B4  |
|   | 5MM      | 33CM   | 52255-13B1        | 52255-13B8  | 52255-13B9  | 52255-13B10  | 52255-13B17   | 52255-13B3  | 52255-13B4  |
|   | 5MM      | 36CM   | 52236-13B1        | 52236-13B8  | 52236-13B9  | 52236-13B10  | 52236-13B17   | 52236-13B3  | 52236-13B4  |
|   | 5MM      | 45CM   | 52155-13B1        | 52155-13B8  | 52155-13B9  | 52155-13B10  | 52155-13B17   | 52155-13B3  | 52155-13B4  |
| <b>PETELIN STRONG RIGHT ANGLE DISSECTOR</b><br>10MM TIP<br> | 5MM      | 24CM   | 52224-113B1       | 52224-113B8 | 52224-113B9 | 52224-113B10 | 52224-113B17  | 52224-113B3 | 52224-113B4 |
|   | 5MM      | 33CM   | 52255-113B1       | 52255-113B8 | 52255-113B9 | 52255-113B10 | 52255-113B17  | 52255-113B3 | 52255-113B4 |
|   | 5MM      | 36CM   | 52236-113B1       | 52236-113B8 | 52236-113B9 | 52236-113B10 | 52236-113B17  | 52236-113B3 | 52236-113B4 |
|   | 5MM      | 45CM   | 52155-113B1       | 52155-113B8 | 52155-113B9 | 52155-113B10 | 52155-113B17  | 52155-113B3 | 52155-113B4 |



WE DESIGN, MANUFACTURE & SELL THE TOOLS THE SURGEONS USE



# 5MM DISSECTORS & GRASPERS



MADE IN THE USA

**BASIN SERIES:**  
ROTATABLE ONE-PIECE INSTRUMENT WITH  
FLUSH PORT



| TIP ID & LENGTH                               | HANDLE |        | TYPE 1            | TYPE 8      | TYPE 9      | TYPE 10      | TYPE 17      | TYPE 3        | TYPE 4      |
|---|--------|--------|-------------------|-------------|-------------|--------------|--------------|---------------|-------------|
|   | DIA.   | LENGTH |                   |             |             |              |              |               |             |
|   |        |        | INSULATED HANDLES |             |             |              |              | NON-INSULATED |             |
| MICRO GRASPER FENESTRATED 10MM TIP<br>        | 5MM    | 24CM   | 52224-14B1        | 52224-14B8  | 52224-14B9  | 52224-14B10  | 52224-14B17  | 52224-14I3    | 52224-14B4  |
|   | 5MM    | 33CM   | 52255-14B1        | 52255-14B8  | 52255-14B9  | 52255-14B10  | 52255-14B17  | 52255-14B3    | 52255-14B4  |
|   | 5MM    | 36CM   | 52236-14B1        | 52236-14B8  | 52236-14B9  | 52236-14B10  | 52236-14B17  | 52236-14B3    | 52236-14B4  |
|   | 5MM    | 45CM   | 52155-14B1        | 52155-14B8  | 52155-14B9  | 52155-14B10  | 52155-14B17  | 52155-14B3    | 52155-14B4  |
| COBRA GRASPER, DA 10MM TIP<br>                | 5MM    | 24CM   | 52224-15B1        | 52224-15B8  | 52224-15B9  | 52224-15B10  | 52224-15B17  | 52224-15B3    | 52224-15B4  |
|   | 5MM    | 33CM   | 52255-15B1        | 52255-15B8  | 52255-15B9  | 52255-15B10  | 52255-15B17  | 52255-15B3    | 52255-15B4  |
|   | 5MM    | 36CM   | 52236-15B1        | 52236-15B8  | 52236-15B9  | 52236-15B10  | 52236-15B17  | 52236-15B3    | 52236-15B4  |
|   | 5MM    | 45CM   | 52155-15B1        | 52155-15B8  | 52155-15B9  | 52155-15B10  | 52155-15B17  | 52155-15B3    | 52155-15B4  |
| BABCOCK GRASPER, FENESTRATED TIP 30MM TIP<br> | 5MM    | 24CM   | 52224-16B1        | 52224-16B8  | 52224-16B9  | 52224-16B10  | 52224-16B17  | 52224-16B3    | 52224-16B4  |
|   | 5MM    | 33CM   | 52255-16B1        | 52255-16B8  | 52255-16B9  | 52255-16B10  | 52255-16B17  | 52255-16B3    | 52255-16B4  |
|   | 5MM    | 36CM   | 52236-16B1        | 52236-16B8  | 52236-16B9  | 52236-16B10  | 52236-16B17  | 52236-16B3    | 52236-16B4  |
|   | 5MM    | 45CM   | 52155-16B1        | 52155-16B8  | 52155-16B9  | 52155-16B10  | 52155-16B17  | 52155-16B3    | 52155-16B4  |
| BABCOCK, AXIS STYLE, FENESTRATED 30MM TIP<br> | 5MM    | 24CM   | 52224-116B1       | 52224-116B8 | 52224-116B9 | 52224-116B10 | 52224-116B17 | 52224-116B3   | 52224-116B4 |
|   | 5MM    | 33CM   | 52255-116B1       | 52255-116B8 | 52255-116B9 | 52255-116B10 | 52255-116B17 | 52255-116B3   | 52255-116B4 |
|   | 5MM    | 36CM   | 52236-116B1       | 52236-116B8 | 52236-116B9 | 52236-116B10 | 52236-116B17 | 52236-116B3   | 52236-116B4 |
|   | 5MM    | 45CM   | 52155-116B1       | 52155-116B8 | 52155-116B9 | 52155-116B10 | 52155-116B17 | 52155-116B3   | 52155-116B4 |
| PADDLE BABCOCK GRASPER 30MM TIP<br>           | 5MM    | 24CM   | 52224-216B1       | 52224-216B8 | 52224-216B9 | 52224-216B10 | 52224-216B17 | 52224-216B3   | 52224-216B4 |
|   | 5MM    | 33CM   | 52255-216B1       | 52255-216B8 | 52255-216B9 | 52255-216B10 | 52255-216B17 | 52255-216B3   | 52255-216B4 |
|   | 5MM    | 36CM   | 52236-216B1       | 52236-216B8 | 52236-216B9 | 52236-216B10 | 52236-216B17 | 52236-216B3   | 52236-216B4 |
|   | 5MM    | 45CM   | 52155-216B1       | 52155-216B8 | 52155-216B9 | 52155-216B10 | 52155-216B17 | 52155-216B3   | 52155-216B4 |
| BABCOCK GRASPER, SHORT DELICATE 20MM TIP<br>  | 5MM    | 24CM   | 52224-17B1        | 52224-17B8  | 52224-17B9  | 52224-17B10  | 52224-17B17  | 52224-17B3    | 52224-17B4  |
|   | 5MM    | 33CM   | 52255-17B1        | 52255-17B8  | 52255-17B9  | 52255-17B10  | 52255-17B17  | 52255-17B3    | 52255-17B4  |
|   | 5MM    | 36CM   | 52236-17B1        | 52236-17B8  | 52236-17B9  | 52236-17B10  | 52236-17B17  | 52236-17B3    | 52236-17B4  |
|   | 5MM    | 45CM   | 52155-17B1        | 52155-17B8  | 52155-17B9  | 52155-17B10  | 52155-17B17  | 52155-17B3    | 52155-17B4  |
| ALLIS GRASPER, SHORT VERSION, SA 15MM TIP<br> | 5MM    | 24CM   | 52224-18B1        | 52224-18B8  | 52224-18B9  | 52224-18B10  | 52224-18B17  | 52224-18B3    | 52224-18B4  |
|   | 5MM    | 33CM   | 52255-18B1        | 52255-18B8  | 52255-18B9  | 52255-18B10  | 52255-18B17  | 52255-18B3    | 52255-18B4  |
|   | 5MM    | 36CM   | 52236-18B1        | 52236-18B8  | 52236-18B9  | 52236-18B10  | 52236-18B17  | 52236-18B3    | 52236-18B4  |
|   | 5MM    | 45CM   | 52155-18B1        | 52155-18B8  | 52155-18B9  | 52155-18B10  | 52155-18B17  | 52155-18B3    | 52155-18B4  |





# 5MM DISSECTORS & GRASPERS



MADE IN THE USA

**BASIN SERIES:**  
ROTATABLE ONE-PIECE INSTRUMENT WITH  
FLUSH PORT



| TIP ID & LENGTH  | HANDLE |        | TYPE 1            | TYPE 8      | TYPE 9      | TYPE 10      | TYPE 17      | TYPE 3        | TYPE 4      |
|--|--------|--------|-------------------|-------------|-------------|--------------|--------------|---------------|-------------|
|  | DIA.   | LENGTH |                   |             |             |              |              |               |             |
|  |        |        | INSULATED HANDLES |             |             |              |              | NON-INSULATED |             |
| ALLIS, SHORT VERSION, 3 X 4 TEETH, SERRATED 12MM TIP<br>       | 5MM    | 24CM   | 52224-19B1        | 52224-19B8  | 52224-19B9  | 52224-19B10  | 52224-19B17  | 52224-19B3    | 52224-19B4  |
|  | 5MM    | 33CM   | 52255-19B1        | 52255-19B8  | 52255-19B9  | 52255-19B10  | 52255-19B17  | 52255-19B3    | 52255-19B4  |
|  | 5MM    | 36CM   | 52236-19B1        | 52236-19B8  | 52236-19B9  | 52236-19B10  | 52236-19B17  | 52236-19B3    | 52236-19B4  |
|  | 5MM    | 45CM   | 52155-19B1        | 52155-19B8  | 52155-19B9  | 52155-19B10  | 52155-19B17  | 52155-19B3    | 52155-19B4  |
| ALLIS, SHORT VERSION, DBL. ROW OF TEETH, SERRATED 12MM TIP<br> | 5MM    | 24CM   | 52224-119B1       | 52224-119B8 | 52224-119B9 | 52224-119B10 | 52224-119B17 | 52224-119B3   | 52224-119B4 |
|  | 5MM    | 33CM   | 52255-119B1       | 52255-119B8 | 52255-119B9 | 52255-119B10 | 52255-119B17 | 52255-119B3   | 52255-119B4 |
|  | 5MM    | 36CM   | 52236-119B1       | 52236-119B8 | 52236-119B9 | 52236-119B10 | 52236-119B17 | 52236-119B3   | 52236-119B4 |
|  | 5MM    | 45CM   | 52155-119B1       | 52155-119B8 | 52155-119B9 | 52155-119B10 | 52155-119B17 | 52155-119B3   | 52155-119B4 |
| ALLIS, LONG VERSION, DBL ROW OF TEETH, SERRATED 25MM TIP<br>   | 5MM    | 24CM   | 52224-219B1       | 52224-219B8 | 52224-219B9 | 52224-219B10 | 52224-219B17 | 52224-219B3   | 52224-219B4 |
|  | 5MM    | 33CM   | 52255-219B1       | 52255-219B8 | 52255-219B9 | 52255-219B10 | 52255-219B17 | 52255-219B3   | 52255-219B4 |
|  | 5MM    | 36CM   | 52236-219B1       | 52236-219B8 | 52236-219B9 | 52236-219B10 | 52236-219B17 | 52236-219B3   | 52236-219B4 |
|  | 5MM    | 45CM   | 52155-219B1       | 52155-219B8 | 52155-219B9 | 52155-219B10 | 52155-219B17 | 52155-219B3   | 52155-219B4 |
| ALLIS GRASPER, MEDIUM, WECK STYLE 20MM TIP<br>                 | 5MM    | 24CM   | 52224-20B1        | 52224-20B8  | 52224-20B9  | 52224-20B10  | 52224-20B17  | 52224-20B3    | 52224-20B4  |
|  | 5MM    | 33CM   | 52255-20B1        | 52255-20B8  | 52255-20B9  | 52255-20B10  | 52255-20B17  | 52255-20B3    | 52255-20B4  |
|  | 5MM    | 36CM   | 52236-20B1        | 52236-20B8  | 52236-20B9  | 52236-20B10  | 52236-20B17  | 52236-20B3    | 52236-20B4  |
|  | 5MM    | 45CM   | 52155-20B1        | 52155-20B8  | 52155-20B9  | 52155-20B10  | 52155-20B17  | 52155-20B3    | 52155-20B4  |
| ALLIS GRASPER, STD. VERSION 30MM TIP<br>                       | 5MM    | 24CM   | 52224-21B1        | 52224-21B8  | 52224-21B9  | 52224-21B10  | 52224-21B17  | 52224-21B3    | 52224-21B4  |
|  | 5MM    | 33CM   | 52255-21B1        | 52255-21B8  | 52255-21B9  | 52255-21B10  | 52255-21B17  | 52255-21B3    | 52255-21B4  |
|  | 5MM    | 36CM   | 52236-21B1        | 52236-21B8  | 52236-21B9  | 52236-21B10  | 52236-21B17  | 52236-21B3    | 52236-21B4  |
|  | 5MM    | 45CM   | 52155-21B1        | 52155-21B8  | 52155-21B9  | 52155-21B10  | 52155-21B17  | 52155-21B3    | 52155-21B4  |
| ALLIS GRASPER, TC, STD VERSION 35MM TIP<br>                    | 5MM    | 24CM   | 52224-57B1        | 52224-57B8  | 52224-57B9  | 52224-57B10  | 52224-57B17  | 52224-57B3    | 52224-57B4  |
|  | 5MM    | 33CM   | 52255-57B1        | 52255-57B8  | 52255-57B9  | 52255-57B10  | 52255-57B17  | 52255-57B3    | 52255-57B4  |
|  | 5MM    | 36CM   | 52236-57B1        | 52236-57B8  | 52236-57B9  | 52236-57B10  | 52236-57B17  | 52236-57B3    | 52236-57B4  |
|  | 5MM    | 45CM   | 52155-57B1        | 52155-57B8  | 52155-57B9  | 52155-57B10  | 52155-57B17  | 52155-57B3    | 52155-57B4  |
| DEBAKEY GRASPER 20MM JAW 20MM TIP<br>                          | 5MM    | 24CM   | 52224-22B1        | 52224-22B8  | 52224-22B9  | 52224-22B10  | 52224-22B17  | 52224-22B3    | 52224-22B4  |
|  | 5MM    | 33CM   | 52255-22B1        | 52255-22B8  | 52255-22B9  | 52255-22B10  | 52255-22B17  | 52255-22B3    | 52255-22B4  |
|  | 5MM    | 36CM   | 52236-22B1        | 52236-22B8  | 52236-22B9  | 52236-22B10  | 52236-22B17  | 52236-22B3    | 52236-22B4  |
|  | 5MM    | 45CM   | 52155-22B1        | 52155-22B8  | 52155-22B9  | 52155-22B10  | 52155-22B17  | 52155-22B3    | 52155-22B4  |





# 5MM DISSECTORS & GRASPERS



MADE IN THE USA

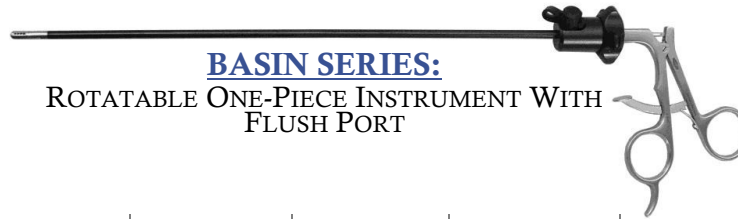

**BASIN SERIES:**  
ROTATABLE ONE-PIECE INSTRUMENT WITH  
FLUSH PORT

| TIP ID & LENGTH                                | HANDLE   |        | TYPE 1            | TYPE 8      | TYPE 9      | TYPE 10      | TYPE 17      | TYPE 3      | TYPE 4      |
|--|----------|--------|-------------------|-------------|-------------|--------------|--------------|-------------|-------------|
|  | DIAMETER | LENGTH |                   |             |             |              |              |             |             |
|  |          |        | INSULATED HANDLES |             |             |              |              | UNINSULATED |             |
| DEBAKEY GRASPER<br>34MM TIP<br>                | 5MM      | 24CM   | 52224-222B1       | 52224-222B8 | 52224-222B9 | 52224-222B10 | 52224-222B17 | 52224-222B3 | 52224-222B4 |
|  | 5MM      | 33CM   | 52255-222B1       | 52255-222B8 | 52255-222B9 | 52255-222B10 | 52255-222B17 | 52255-222B3 | 52255-222B4 |
|  | 5MM      | 36CM   | 52236-222B1       | 52236-222B8 | 52236-222B9 | 52236-222B10 | 52236-222B17 | 52236-222B3 | 52236-222B4 |
|  | 5MM      | 45CM   | 52155-222B1       | 52155-222B8 | 52155-222B9 | 52155-222B10 | 52155-222B17 | 52155-222B3 | 52155-222B4 |
| DEBAKEY GRASPER<br>40MM TIP<br>                | 5MM      | 24CM   | 52224-23B1        | 52224-23B8  | 52224-23B9  | 52224-23B10  | 52224-23B17  | 52224-23B3  | 52224-23B4  |
|  | 5MM      | 33CM   | 52255-23B1        | 52255-23B8  | 52255-23B9  | 52255-23B10  | 52255-23B17  | 52255-23B3  | 52255-23B4  |
|  | 5MM      | 36CM   | 52236-23B1        | 52236-23B8  | 52236-23B9  | 52236-23B10  | 52236-23B17  | 52236-23B3  | 52236-23B4  |
|  | 5MM      | 45CM   | 52155-23B1        | 52155-23B8  | 52155-23B9  | 52155-23B10  | 52155-23B17  | 52155-23B3  | 52155-23A4  |
| DEBAKEY GRASPER<br>60MM TIP<br>                | 5MM      | 24CM   | 52224-160B1       | 52224-160B8 | 52224-160B9 | 52224-160B10 | 52224-160B17 | 52224-160B3 | 52224-160B4 |
|  | 5MM      | 33CM   | 52255-160B1       | 52255-160B8 | 52255-160B9 | 52255-160B10 | 52255-160B17 | 52255-160B3 | 52255-160B4 |
|  | 5MM      | 36CM   | 52236-160B1       | 52236-160B8 | 52236-160B9 | 52236-160B10 | 52236-160B17 | 52236-160B3 | 52236-160B4 |
|  | 5MM      | 45CM   | 52155-160B1       | 52155-160B8 | 52155-160B9 | 52155-160B10 | 52155-160B17 | 52155-160B3 | 52155-160B4 |
| HUNTER DEBAKEY,<br>FENESTRATED<br>16MM TIP<br> | 5MM      | 24CM   | 52224-158B1       | 52224-158B8 | 52224-158B9 | 52224-158B10 | 52224-158B17 | 52224-158B3 | 52224-158B4 |
|  | 5MM      | 33CM   | 52255-158B1       | 52255-158B8 | 52255-158B9 | 52255-158B10 | 52255-158B17 | 52255-158B3 | 52255-158B4 |
|  | 5MM      | 36CM   | 52236-158B1       | 52236-158B8 | 52236-158B9 | 52236-158B10 | 52236-158B17 | 52236-158B3 | 52236-158B4 |
|  | 5MM      | 45CM   | 52155-158B1       | 52155-158B8 | 52155-158B9 | 52155-158B10 | 52155-158B17 | 52155-158B3 | 52155-158B4 |
| HUNTER DEBAKEY,<br>FENESTRATED<br>20MM TIP<br> | 5MM      | 24CM   | 52224-58B1        | 52224-58B8  | 52224-58B9  | 52224-58B10  | 52224-58B17  | 52224-58B3  | 52224-58B4  |
|  | 5MM      | 33CM   | 52255-58B1        | 52255-58B8  | 52255-58B9  | 52255-58B10  | 52255-58B17  | 52255-58B3  | 52255-58B4  |
|  | 5MM      | 36CM   | 52236-58B1        | 52236-58B8  | 52236-58B9  | 52236-58B10  | 52236-58B17  | 52236-58B3  | 52236-58B4  |
|  | 5MM      | 45CM   | 52155-58B1        | 52155-58B8  | 52155-58B9  | 52155-58B10  | 52155-58B17  | 52155-58B3  | 52155-58B4  |
| HUNTER DEBAKEY,<br>FENESTRATED<br>40MM TIP<br> | 5MM      | 24CM   | 52224-159B1       | 52224-159B8 | 52224-159B9 | 52224-159B10 | 52224-159B17 | 52224-159B3 | 52224-159B4 |
|  | 5MM      | 33CM   | 52255-159B1       | 52255-159B8 | 52255-159B9 | 52255-159B10 | 52255-159B17 | 52255-159B3 | 52255-159B4 |
|  | 5MM      | 36CM   | 52236-159B1       | 52236-159B8 | 52236-159B9 | 52236-159B10 | 52236-159B17 | 52236-159B3 | 52236-159B4 |
|  | 5MM      | 45CM   | 52155-159B1       | 52155-159B8 | 52155-159B9 | 52155-159B10 | 52155-159B17 | 52155-159B3 | 52155-159B4 |
| HUNTER DEBAKEY,<br>FENESTRATED<br>60MM TIP<br> | 5MM      | 24CM   | 52224-160B1       | 52224-160B8 | 52224-160B9 | 52224-160B10 | 52224-160B17 | 52224-160B3 | 52224-160B4 |
|  | 5MM      | 33CM   | 52255-160B1       | 52255-160B8 | 52255-160B9 | 52255-160B10 | 52255-160B17 | 52255-160B3 | 52255-160B4 |
|  | 5MM      | 36CM   | 52236-160B1       | 52236-160B8 | 52236-160B9 | 52236-160B10 | 52236-160B17 | 52236-160B3 | 52236-160B4 |
|  | 5MM      | 45CM   | 52155-160B1       | 52155-160B8 | 52155-160B9 | 52155-160B10 | 52155-160B17 | 52155-160B3 | 52155-160B4 |





# 5MM DISSECTORS & GRASPERS



MADE IN THE USA

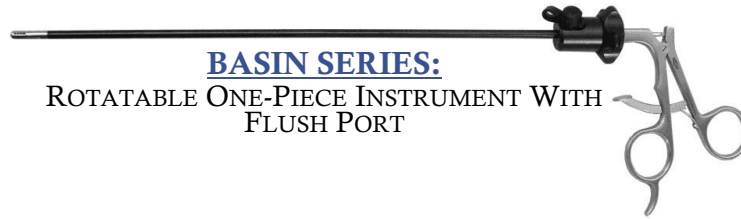

**BASIN SERIES:**  
ROTATABLE ONE-PIECE INSTRUMENT WITH  
FLUSH PORT

| TIP ID & LENGTH  | HANDLE   |        | TYPE 1            | TYPE 8      | TYPE 9      | TYPE 10      | TYPE 17      | TYPE 3        | TYPE 4      |
|--|----------|--------|-------------------|-------------|-------------|--------------|--------------|---------------|-------------|
|  | DIAMETER | LENGTH |                   |             |             |              |              |               |             |
|  |          |        | INSULATED HANDLES |             |             |              |              | NON-INSULATED |             |
| "WINER" STYLE<br>FUNDUS GRASPER<br>16MM TIP<br>                  | 5MM      | 24CM   | 52224-326B1       | 52224-326B8 | 52224-326B9 | 52224-326B10 | 52224-326B17 | 52224-326B3   | 52224-326B4 |
|  | 5MM      | 33CM   | 52255-326B1       | 52255-326B8 | 52255-326B9 | 52255-326B10 | 52255-326B17 | 52255-326B3   | 52255-326B4 |
|  | 5MM      | 36CM   | 52236-326B1       | 52236-326B8 | 52236-326B9 | 52236-326B10 | 52236-326B17 | 52236-326B3   | 52236-326B4 |
|  | 5MM      | 45CM   | 52155-326B1       | 52155-326B8 | 52155-326B9 | 52155-326B10 | 52155-326B17 | 52155-326B3   | 52155-326B4 |
| "JARIT STYLE"<br>GRASPING FORCEPS<br>DUAL CUP<br>16MM TIP<br>    | 5MM      | 24CM   | 52224-426B1       | 52224-426B8 | 52224-426B9 | 52224-426B10 | 52224-426B17 | 52224-426B3   | 52224-426B4 |
|  | 5MM      | 33CM   | 52255-426B1       | 52255-426B8 | 52255-426B9 | 52255-426B10 | 52255-426B17 | 52255-426B3   | 52255-426B4 |
|  | 5MM      | 36CM   | 52236-426B1       | 52236-426B8 | 52236-426B9 | 52236-426B10 | 52236-426B17 | 52236-426B3   | 52236-426B4 |
|  | 5MM      | 45CM   | 52155-426B1       | 52155-426B8 | 52155-426B9 | 52155-426B10 | 52155-426B17 | 52155-426B3   | 52155-426B4 |
| ENDOCLINCH<br>FENESTRATED<br>GRASPER<br>20MM TIP<br>             | 5MM      | 24CM   | 52224-27B1        | 52224-27B8  | 52224-27B9  | 52224-27B10  | 52224-27B17  | 52224-27B3    | 52224-27B4  |
|  | 5MM      | 33CM   | 52255-27B1        | 52255-27B8  | 52255-27B9  | 52255-27B10  | 52255-27B17  | 52255-27B3    | 52255-27B4  |
|  | 5MM      | 36CM   | 52236-27B1        | 52236-27B8  | 52236-27B9  | 52236-27B10  | 52236-27B17  | 52236-27B3    | 52236-27B4  |
|  | 5MM      | 45CM   | 52155-27B1        | 52155-27B8  | 52155-27B9  | 52155-27B10  | 52155-27B17  | 52155-27B3    | 52155-27B4  |
| RETRO-FACING,<br>RAT TOOTH W/<br>CUP<br>10MM TIP<br>             | 5MM      | 24CM   | 52224-28B1        | 52224-28B8  | 52224-28B9  | 52224-28B10  | 52224-28B17  | 52224-28B3    | 52224-28B4  |
|  | 5MM      | 33CM   | 52255-28B1        | 52255-28B8  | 52255-28B9  | 52255-28B10  | 52255-28B17  | 52255-28B3    | 52255-28B4  |
|  | 5MM      | 36CM   | 52236-28B1        | 52236-28B8  | 52236-28B9  | 52236-28B10  | 52236-28B17  | 52236-28B3    | 52236-28B4  |
|  | 5MM      | 45CM   | 52155-28B1        | 52155-28B8  | 52155-28B9  | 52155-28B10  | 52155-28B17  | 52155-28B3    | 52155-28B4  |
| ALLIGATOR<br>GRASPER, RETRO-<br>FACING TEETH, DA<br>10MM TIP<br> | 5MM      | 24CM   | 52224-29B1        | 52224-29B8  | 52224-29B9  | 52224-29B10  | 52224-29B17  | 52224-29B3    | 52224-29B4  |
|  | 5MM      | 33CM   | 52255-29B1        | 52255-29B8  | 52255-29B9  | 52255-29B10  | 52255-29B17  | 52255-29B3    | 52255-29B4  |
|  | 5MM      | 36CM   | 52236-29B1        | 52236-29B8  | 52236-29B9  | 52236-29B10  | 52236-29B17  | 52236-29B3    | 52236-29B4  |
|  | 5MM      | 45CM   | 52155-29B1        | 52155-29B8  | 52155-29B9  | 52155-29B10  | 52155-29B17  | 52155-29B3    | 52155-29B4  |
| ALLIGATOR<br>GRASPER, RETRO-<br>FACING TEETH, DA<br>20MM TIP<br> | 5MM      | 24CM   | 52224-129B1       | 52224-129B8 | 52224-129B9 | 52224-129B10 | 52224-129B17 | 52224-129B3   | 52224-129B4 |
|  | 5MM      | 33CM   | 52255-129B1       | 52255-129B8 | 52255-129B9 | 52255-129B10 | 52255-129B17 | 52255-129B3   | 52255-129B4 |
|  | 5MM      | 36CM   | 52236-129B1       | 52236-129B8 | 52236-129B9 | 52236-129B10 | 52236-129B17 | 52236-129B3   | 52236-129B4 |
|  | 5MM      | 45CM   | 52155-129B1       | 52155-129B8 | 52155-129B9 | 52155-129B10 | 52155-129B17 | 52155-129B3   | 52155-129B4 |
| ALLIGATOR<br>GRASPER, RETRO-<br>FACING TEETH, SA<br>10MM TIP<br> | 5MM      | 24CM   | 52224-30B1        | 52224-30B8  | 52224-30B9  | 52224-30B10  | 52224-30B17  | 52224-30B3    | 52224-30B4  |
|  | 5MM      | 33CM   | 52255-30B1        | 52255-30B8  | 52255-30B9  | 52255-30B10  | 52255-30B17  | 52255-30B3    | 52255-30B4  |
|  | 5MM      | 36CM   | 52236-30B1        | 52236-30B8  | 52236-30B9  | 52236-30B10  | 52236-30B17  | 52236-30B3    | 52236-30B4  |
|  | 5MM      | 45CM   | 52155-30B1        | 52155-30B8  | 52155-30B9  | 52155-30B10  | 52155-30B17  | 52155-30B3    | 52155-30B4  |





# 5MM DISSECTORS & GRASPERS



MADE IN THE USA

**BASIN SERIES:**  
ROTATABLE ONE-PIECE INSTRUMENT WITH  
FLUSH PORT



| TIP ID & LENGTH  | HANDLE   |        | TYPE 1      | TYPE 8      | TYPE 9      | TYPE 10      | TYPE 17      | TYPE 3        | TYPE 4      |
|--|----------|--------|-------------|-------------|-------------|--------------|--------------|---------------|-------------|
|  | DIAMETER | LENGTH |             |             |             |              |              |               |             |
|  |          |        | INSULATED   |             |             |              |              | NON-INSULATED |             |
| CUP SHAPED GRASPER, W/ RETRO-FACING TEETH<br>10MM TIP<br>        | 5MM      | 24CM   | 52224-31B1  | 52224-31B8  | 52224-31B9  | 52224-31B10  | 52224-31B17  | 52224-31B3    | 52224-31B4  |
|  | 5MM      | 33CM   | 52255-31B1  | 52255-31B8  | 52255-31B9  | 52255-31B10  | 52255-31B17  | 52255-31B3    | 52255-31B4  |
|  | 5MM      | 36CM   | 52236-31B1  | 52236-31B8  | 52236-31B9  | 52236-31B10  | 52236-31B17  | 52236-31B3    | 52236-31B4  |
|  | 5MM      | 45CM   | 52155-31B1  | 52155-31B8  | 52155-31B9  | 52155-31B10  | 52155-31B17  | 52155-31B3    | 52155-31B4  |
| WAVE GRASPER, LONG BEVELED EDGE, DA<br>22MM TIP<br>              | 5MM      | 24CM   | 52224-32B1  | 52224-32B8  | 52224-32B9  | 52224-32B10  | 52224-32B17  | 52224-32B3    | 52224-32B4  |
|  | 5MM      | 33CM   | 52255-32B1  | 52255-32B8  | 52255-32B9  | 52255-32B10  | 52255-32B17  | 52255-32B3    | 52255-32B4  |
|  | 5MM      | 36CM   | 52236-32B1  | 52236-32B8  | 52236-32B9  | 52236-32B10  | 52236-32B17  | 52236-32B3    | 52236-32B4  |
|  | 5MM      | 45CM   | 52155-32B1  | 52155-32B8  | 52155-32B9  | 52155-32B10  | 52155-32B17  | 52155-32B3    | 52155-32B4  |
| WAVE GRASPER, LONG BEVELED EDGE, SA<br>22MM TIP<br>              | 5MM      | 24CM   | 52224-33B1  | 52224-33B8  | 52224-33B9  | 52224-33B10  | 52224-33B17  | 52224-33B3    | 52224-33B4  |
|  | 5MM      | 33CM   | 52255-33B1  | 52255-33B8  | 52255-33B9  | 52255-33B10  | 52255-33B17  | 52255-33B3    | 52255-33B4  |
|  | 5MM      | 36CM   | 52236-33B1  | 52236-33B8  | 52236-33B9  | 52236-33B10  | 52236-33B17  | 52236-33B3    | 52236-33B4  |
|  | 5MM      | 45CM   | 52155-33B1  | 52155-33B8  | 52155-33B9  | 52155-33B10  | 52155-33B17  | 52155-33B3    | 52155-33B4  |
| RETRACTION GRASPER, 2 X 3 TEETH, COBRA STYLE, DA<br>20MM TIP<br> | 5MM      | 24CM   | 52224-34B1  | 52224-34B8  | 52224-34B9  | 52224-34B10  | 52224-34B17  | 52224-34B3    | 52224-34B4  |
|  | 5MM      | 33CM   | 52255-34B1  | 52255-34B8  | 52255-34B9  | 52255-34B10  | 52255-34B17  | 52255-34B3    | 52255-34B4  |
|  | 5MM      | 36CM   | 52236-34B1  | 52236-34B8  | 52236-34B9  | 52236-34B10  | 52236-34B17  | 52236-34B3    | 52236-34B4  |
|  | 5MM      | 45CM   | 52155-34B1  | 52155-34B8  | 52155-34B9  | 52155-34B10  | 52155-34B17  | 52155-34B3    | 52155-34B4  |
| RETRACTION GRASPER, 2 X 3 TEETH, COBRA STYLE, SA<br>20MM TIP<br> | 5MM      | 24CM   | 52224-35B1  | 52224-35B8  | 52224-35B9  | 52224-35B10  | 52224-35B17  | 52224-35B3    | 52224-35B4  |
|  | 5MM      | 33CM   | 52255-35B1  | 52255-35B8  | 52255-35B9  | 52255-35B10  | 52255-35B17  | 52255-35B3    | 52255-35B4  |
|  | 5MM      | 36CM   | 52236-35B1  | 52236-35B8  | 52236-35B9  | 52236-35B10  | 52236-35B17  | 52236-35B3    | 52236-35B4  |
|  | 5MM      | 45CM   | 52155-35B1  | 52155-35B8  | 52155-35B9  | 52155-35B10  | 52155-35B17  | 52155-35B3    | 52155-35B4  |
| RETRACTION GRASPER, 2 X 3 TEETH, JARIT STYLE, DA<br>20MM TIP<br> | 5MM      | 24CM   | 52224-134B1 | 52224-134B8 | 52224-134B9 | 52224-134B10 | 52224-134B17 | 52224-134B3   | 52224-134B4 |
|  | 5MM      | 33CM   | 52255-134B1 | 52255-134B8 | 52255-134B9 | 52255-134B10 | 52255-134B17 | 52255-134B3   | 52255-134B4 |
|  | 5MM      | 36CM   | 52236-134B1 | 52236-134B8 | 52236-134B9 | 52236-134B10 | 52236-134B17 | 52236-134B3   | 52236-134B4 |
|  | 5MM      | 45CM   | 52155-134B1 | 52155-134B8 | 52155-134B9 | 52155-134B10 | 52155-134B17 | 52155-134B3   | 52155-134B4 |
| RETRACTION GRASPER, 2 X 3 TEETH, JARIT STYLE, SA<br>20MM TIP<br> | 5MM      | 24CM   | 52224-135B1 | 52224-135B8 | 52224-135B9 | 52224-135B10 | 52224-135B17 | 52224-135B3   | 52224-135B4 |
|  | 5MM      | 33CM   | 52255-135B1 | 52255-135B8 | 52255-135B9 | 52255-135B10 | 52255-135B17 | 52255-135B3   | 52255-135B4 |
|  | 5MM      | 36CM   | 52236-135B1 | 52236-135B8 | 52236-135B9 | 52236-135B10 | 52236-135B17 | 52236-135B3   | 52236-135B4 |
|  | 5MM      | 45CM   | 52155-135B1 | 52155-135B8 | 52155-135B9 | 52155-135B10 | 52155-135B17 | 52155-135B3   | 52155-135B4 |





# 5MM DISSECTORS & GRASPERS



MADE IN THE USA

**BASIN SERIES:**  
ROTATABLE ONE-PIECE INSTRUMENT WITH  
FLUSH PORT



| TIP ID & LENGTH  | HANDLE   |        | TYPE 1            | TYPE 8      | TYPE 9      | TYPE 10      | TYPE 17       | TYPE 3      | TYPE 4      |
|--|----------|--------|-------------------|-------------|-------------|--------------|---------------|-------------|-------------|
|  | DIAMETER | LENGTH |                   |             |             |              |               |             |             |
|  |          |        | INSULATED HANDLES |             |             |              | NON-INSULATED |             |             |
| CLAW GRASPER,<br>2 X 3 TEETH, SA<br>20MM TIP<br>                         | 5MM      | 24CM   | 52224-36B1        | 52224-36B8  | 52224-36B9  | 52224-36B10  | 52224-36B17   | 52224-36B3  | 52224-36B4  |
|  | 5MM      | 33CM   | 52255-36B1        | 52255-36B8  | 52255-36B9  | 52255-36B10  | 52255-36B17   | 52255-36B3  | 52255-36B4  |
|  | 5MM      | 36CM   | 52236-36B1        | 52236-36B8  | 52236-36B9  | 52236-36B10  | 52236-36B17   | 52236-36B3  | 52236-36B4  |
|  | 5MM      | 45CM   | 52155-36B1        | 52155-36B8  | 52155-36B9  | 52155-36B10  | 52155-36B17   | 52155-36B3  | 52155-36B4  |
| CLAW GRASPER,<br>2 X 3 TEETH, W/<br>XTRA ROW OF<br>TEETH<br>20MM TIP<br> | 5MM      | 24CM   | 52224-136B1       | 52224-136B8 | 52224-136B9 | 52224-136B10 | 52224-136B17  | 52224-136B3 | 52224-136B4 |
|  | 5MM      | 33CM   | 52255-136B1       | 52255-136B8 | 52255-136B9 | 52255-136B10 | 52255-136B17  | 52255-136B3 | 52255-136B4 |
|  | 5MM      | 36CM   | 52236-136B1       | 52236-136B8 | 52236-136B9 | 52236-136B10 | 52236-136B17  | 52236-136B3 | 52236-136B4 |
|  | 5MM      | 45CM   | 52155-136B1       | 52155-136B8 | 52155-136B9 | 52155-136B10 | 52155-136B17  | 52155-136B3 | 52155-136B4 |
| ATRAUMATIC<br>FENESTRATED<br>GRASPER,<br>CURVED<br>16MM TIP<br>          | 5MM      | 24CM   | 52224-37B1        | 52224-37B8  | 52224-37B9  | 52224-37B10  | 52224-37B17   | 52224-37B3  | 52224-37B4  |
|  | 5MM      | 33CM   | 52255-37B1        | 52255-37B8  | 52255-37B9  | 52255-37B10  | 52255-37B17   | 52255-37B3  | 52255-37B4  |
|  | 5MM      | 36CM   | 52236-37B1        | 52236-37B8  | 52236-37B9  | 52236-37B10  | 52236-37B17   | 52236-37B3  | 52236-37B4  |
|  | 5MM      | 45CM   | 52155-37B1        | 52155-37B8  | 52155-37B9  | 52155-37B10  | 52155-37B17   | 52155-37B3  | 52155-37B4  |
| FENESTRATED<br>GRASPER,<br>16MM JAW<br>16MM TIP<br>                      | 5MM      | 24CM   | 52224-38B1        | 52224-38B8  | 52224-38B9  | 52224-38B10  | 52224-38B17   | 52224-38B3  | 52224-38B4  |
|  | 5MM      | 33CM   | 52255-38B1        | 52255-38B8  | 52255-38B9  | 52255-38B10  | 52255-38B17   | 52255-38B3  | 52255-38B4  |
|  | 5MM      | 36CM   | 52236-38B1        | 52236-38B8  | 52236-38B9  | 52236-38B10  | 52236-38B17   | 52236-38B3  | 52236-38B4  |
|  | 5MM      | 45CM   | 52155-38B1        | 52155-38B8  | 52155-38B9  | 52155-38B10  | 52155-38B17   | 52155-38B3  | 52155-38B4  |
| FENESTRATED<br>GRASPER,<br>20MM JAW<br>20MM TIP<br>                      | 5MM      | 24CM   | 52224-39B1        | 52224-39B8  | 52224-39B9  | 52224-39B10  | 52224-39B17   | 52224-39B3  | 52224-39B4  |
|  | 5MM      | 33CM   | 52255-39B1        | 52255-39B8  | 52255-39B9  | 52255-39B10  | 52255-39B17   | 52255-39B3  | 52255-39B4  |
|  | 5MM      | 36CM   | 52236-39B1        | 52236-39B8  | 52236-39B9  | 52236-39B10  | 52236-39B17   | 52236-39B3  | 52236-39B4  |
|  | 5MM      | 45CM   | 52155-39B1        | 52155-39B8  | 52155-39B9  | 52155-39B10  | 52155-39B17   | 52155-39B3  | 52155-39B4  |
| FENESTRATED<br>GRASPER<br>40MM JAW<br>40MM TIP<br>                       | 5MM      | 24CM   | 52224-40B1        | 52224-40B8  | 52224-40B9  | 52224-40B10  | 52224-40B17   | 52224-40B3  | 52224-40B4  |
|  | 5MM      | 33CM   | 52255-40B1        | 52255-40B8  | 52255-40B9  | 52255-40B10  | 52255-40B17   | 52255-40B3  | 52255-40B4  |
|  | 5MM      | 36CM   | 52236-40B1        | 52236-40B8  | 52236-40B9  | 52236-40B10  | 52236-40B17   | 52236-40B3  | 52236-40B4  |
|  | 5MM      | 45CM   | 52155-40B1        | 52155-40B8  | 52155-40B9  | 52155-40B10  | 52155-40B17   | 52155-40B3  | 52155-40B4  |
| JOHAN<br>FENESTRATED<br>GRASPER<br>20MM TIP, SA<br>20MM TIP<br>          | 5MM      | 24CM   | 52224-41B1        | 52224-41B8  | 52224-41B9  | 52224-41B10  | 52224-41B17   | 52224-41B3  | 52224-41B4  |
|  | 5MM      | 33CM   | 52255-41B1        | 52255-41B8  | 52255-41B9  | 52255-41B10  | 52255-41B17   | 52255-41B3  | 52255-41B4  |
|  | 5MM      | 36CM   | 52236-41B1        | 52236-41B8  | 52236-41B9  | 52236-41B10  | 52236-41B17   | 52236-41B3  | 52236-41B4  |
|  | 5MM      | 45CM   | 52155-41B1        | 52155-41B8  | 52155-41B9  | 52155-41B10  | 52155-41B17   | 52155-41B3  | 52155-41B4  |





# 5MM DISSECTORS & GRASPERS



MADE IN THE USA

**BASIN SERIES:**  
ROTATABLE ONE-PIECE INSTRUMENT WITH  
FLUSH PORT



| TIP ID & LENGTH  | HANDLE |        | TYPE 1            | TYPE 8      | TYPE 9      | TYPE 10      | TYPE 17      | TYPE 3        | TYPE 4      |
|--|--------|--------|-------------------|-------------|-------------|--------------|--------------|---------------|-------------|
|  | DIA.   | LENGTH |                   |             |             |              |              |               |             |
|  |        |        | INSULATED HANDLES |             |             |              |              | NON-INSULATED |             |
| <b>JOHANN FENESTRATED GRASPER, SA 45MM TIP</b><br>                   | 5MM    | 24CM   | 52224-42B1        | 52224-42B8  | 52224-42B9  | 52224-42B10  | 52224-42B17  | 52224-42B3    | 52224-42B4  |
|  | 5MM    | 33CM   | 52255-42B1        | 52255-42B8  | 52255-42B9  | 52255-42B10  | 52255-42B17  | 52255-42B3    | 52255-42B4  |
|  | 5MM    | 36CM   | 52236-42B1        | 52236-42B8  | 52236-42B9  | 52236-42B10  | 52236-42B17  | 52236-42B3    | 52236-42B4  |
|  | 5MM    | 45CM   | 52155-42B1        | 52155-42B8  | 52155-42B9  | 52155-42B10  | 52155-42B17  | 52155-42B3    | 52155-42B4  |
| <b>DOUBLE FENESTRATED GRASPER 25MM TIP</b><br>                       | 5MM    | 24CM   | 52224-139B1       | 52224-139B8 | 52224-139B9 | 52224-139B10 | 52224-139B17 | 52224-139B3   | 52224-139B4 |
|  | 5MM    | 33CM   | 52255-139B1       | 52255-139B8 | 52255-139B9 | 52255-139B10 | 52255-139B17 | 52255-139B3   | 52255-139B4 |
|  | 5MM    | 36CM   | 52236-139B1       | 52236-139B8 | 52236-139B9 | 52236-139B10 | 52236-139B17 | 52236-139B3   | 52236-139B4 |
|  | 5MM    | 45CM   | 52155-139B1       | 52155-139B8 | 52155-139B9 | 52155-139B10 | 52155-139B17 | 52155-139B3   | 52155-139B4 |
| <b>KOCHER GRASPER, 1 X 2 TEETH, SA 15MM TIP</b><br>                  | 5MM    | 24CM   | 52224-43B1        | 52224-43B8  | 52224-43B9  | 52224-43B10  | 52224-43B17  | 52224-43B3    | 52224-43B4  |
|  | 5MM    | 33CM   | 52255-43B1        | 52255-43B8  | 52255-43B9  | 52255-43B10  | 52255-43B17  | 52255-43B3    | 52255-43B4  |
|  | 5MM    | 36CM   | 52236-43B1        | 52236-43B8  | 52236-43B9  | 52236-43B10  | 52236-43B17  | 52236-43B3    | 52236-43B4  |
|  | 5MM    | 45CM   | 52155-43B1        | 52155-43B8  | 52155-43B9  | 52155-43B10  | 52155-43B17  | 52155-43B3    | 52155-43B4  |
| <b>KOCHER GRASPER, 1 X 2 TEETH, DA (WECK TYPE) 15MM TIP</b><br>      | 5MM    | 24CM   | 52224-44B1        | 52224-44B8  | 52224-44B9  | 52224-44B10  | 52224-44B17  | 52224-44B3    | 52224-44B4  |
|  | 5MM    | 33CM   | 52255-44B1        | 52255-44B8  | 52255-44B9  | 52255-44B10  | 52255-44B17  | 52255-44B3    | 52255-44B4  |
|  | 5MM    | 36CM   | 52236-44B1        | 52236-44B8  | 52236-44B9  | 52236-44B10  | 52236-44B17  | 52236-44B3    | 52236-44B4  |
|  | 5MM    | 45CM   | 52155-44B1        | 52155-44B8  | 52155-44B9  | 52155-44B10  | 52155-44B17  | 52155-44B3    | 52155-44B4  |
| <b>SCHROEDER TENACULUM, SINGLE TOOTH, ROUND TIP 25MM TIP</b><br>     | 5MM    | 24CM   | 52224-45B1        | 52224-45B8  | 52224-45B9  | 52224-45B10  | 52224-45B17  | 52224-45B3    | 52224-45B4  |
|  | 5MM    | 33CM   | 52255-45B1        | 52255-45B8  | 52255-45B9  | 52255-45B10  | 52255-45B17  | 52255-45B3    | 52255-45B4  |
|  | 5MM    | 36CM   | 52236-45B1        | 52236-45B8  | 52236-45B9  | 52236-45B10  | 52236-45B17  | 52236-45B3    | 52236-45B4  |
|  | 5MM    | 45CM   | 52155-45B1        | 52155-45B8  | 52155-45B9  | 52155-45B10  | 52155-45B17  | 52155-45B3    | 52155-45B4  |
| <b>SCHROEDER TENACULUM, SINGLE TOOTH, SQUARE TIP 25MM TIP</b><br>    | 5MM    | 24CM   | 52224-245B1       | 52224-245B8 | 52224-245B9 | 52224-245B10 | 52224-245B17 | 52224-245B3   | 52224-245B4 |
|  | 5MM    | 33CM   | 52255-245B1       | 52255-245B8 | 52255-245B9 | 52255-245B10 | 52255-245B17 | 52255-245B3   | 52255-245B4 |
|  | 5MM    | 36CM   | 52236-245B1       | 52236-245B8 | 52236-245B9 | 52236-245B10 | 52236-245B17 | 52236-245B3   | 52236-245B4 |
|  | 5MM    | 45CM   | 52155-245B1       | 52155-245B8 | 52155-245B9 | 52155-245B10 | 52155-245B17 | 52155-245B3   | 52155-245B4 |
| <b>SCHROEDER TEN. GRASPER, SINGLE TOOTH, XTRA TOOTH 25MM TIP</b><br> | 5MM    | 24CM   | 52224-94B1        | 52224-94B8  | 52224-94B9  | 52224-94B10  | 52224-94B17  | 52224-94B3    | 52224-94B4  |
|  | 5MM    | 33CM   | 52255-94B1        | 52255-94B8  | 52255-94B9  | 52255-94B10  | 52255-94B17  | 52255-94B3    | 52255-94B4  |
|  | 5MM    | 36CM   | 52236-94B1        | 52236-94B8  | 52236-94B9  | 52236-94B10  | 52236-94B17  | 52236-94B3    | 52236-94B4  |
|  | 5MM    | 45CM   | 52155-94B1        | 52155-94B8  | 52155-94B9  | 52155-94B10  | 52155-94B17  | 52155-94B3    | 52155-94B4  |





# 5MM DISSECTORS & GRASPERS



MADE IN THE USA

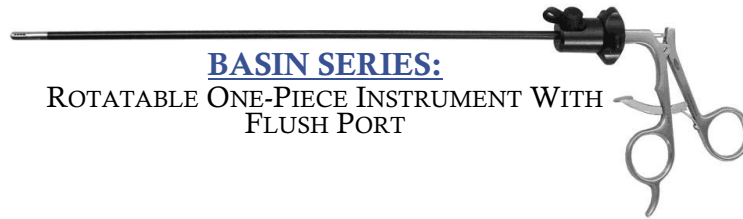

**BASIN SERIES:**  
ROTATABLE ONE-PIECE INSTRUMENT WITH  
FLUSH PORT

| TIP ID & LENGTH                               | HANDLE |        | TYPE 1            | TYPE 8      | TYPE 9      | TYPE 10      | TYPE 17      | TYPE 3        | TYPE 4      |
|---|--------|--------|-------------------|-------------|-------------|--------------|--------------|---------------|-------------|
|   | DIA.   | LENGTH |                   |             |             |              |              |               |             |
|   |        |        | INSULATED HANDLES |             |             |              |              | NON-INSULATED |             |
| DEBAKEY GRASPER, CURVED 30MM TIP<br>          | 5MM    | 24CM   | 52224-46B1        | 52224-46B8  | 52224-46B9  | 52224-46B10  | 52224-46B17  | 52224-46B3    | 52224-46B4  |
|   | 5MM    | 33CM   | 52255-46B1        | 52255-46B8  | 52255-46B9  | 52255-46B10  | 52255-46B17  | 52255-46B3    | 52255-46B4  |
|   | 5MM    | 36CM   | 52236-46B1        | 52236-46B8  | 52236-46B9  | 52236-46B10  | 52236-46B17  | 52236-46B3    | 52236-46B4  |
|   | 5MM    | 45CM   | 52155-46B1        | 52155-46B8  | 52155-46B9  | 52155-46B10  | 52155-46B17  | 52155-46B3    | 52155-46B4  |
| DEBAKEY MARYLAND GRASPER 35MM TIP<br>         | 5MM    | 24CM   | 52224-149B1       | 52224-149B8 | 52224-149B9 | 52224-149B10 | 52224-149B17 | 52224-149B3   | 52224-149B4 |
|   | 5MM    | 33CM   | 52255-149B1       | 52255-149B8 | 52255-149B9 | 52255-149B10 | 52255-149B17 | 52255-149B3   | 52255-149B4 |
|   | 5MM    | 36CM   | 52236-149B1       | 52236-149B8 | 52236-149B9 | 52236-149B10 | 52236-149B17 | 52236-149B3   | 52236-149B4 |
|   | 5MM    | 45CM   | 52155-149B1       | 52155-149B8 | 52155-149B9 | 52155-149B10 | 52155-149B17 | 52155-149B3   | 52155-149B4 |
| GLASSMAN ATRAUMATIC GRASPER 30MM TIP<br>      | 5MM    | 24CM   | 52224-24B1        | 52224-24B8  | 52224-24B9  | 52224-24B10  | 52224-24B17  | 52224-24B3    | 52224-24B4  |
|   | 5MM    | 33CM   | 52255-24B1        | 52255-24B8  | 52255-24B9  | 52255-24B10  | 52255-24B17  | 52255-24B3    | 52255-24B4  |
|   | 5MM    | 36CM   | 52236-24B1        | 52236-24B8  | 52236-24B9  | 52236-24B10  | 52236-24B17  | 52236-24B3    | 52236-24B4  |
|   | 5MM    | 45CM   | 52155-24B1        | 52155-24B8  | 52155-24B9  | 52155-24B10  | 52155-24B17  | 52155-24B3    | 52155-24B4  |
| GRASPER, CROSS SERRATED, SA 10MM TIP<br>      | 5MM    | 24CM   | 52224-25B1        | 52224-25B8  | 52224-25B9  | 52224-25B10  | 52224-25B17  | 52224-25B3    | 52224-25B4  |
|   | 5MM    | 33CM   | 52255-25B1        | 52255-25B8  | 52255-25B9  | 52255-25B10  | 52255-25B17  | 52255-25B3    | 52255-25B4  |
|   | 5MM    | 36CM   | 52236-25B1        | 52236-25B8  | 52236-25B9  | 52236-25B10  | 52236-25B17  | 52236-25B3    | 52236-25B4  |
|   | 5MM    | 45CM   | 52155-25B1        | 52155-25B8  | 52155-25B9  | 52155-25B10  | 52155-25B17  | 52155-25B3    | 52155-25B4  |
| DOUBLE CUP FUNDUS MAXI GRASPER 16MM TIP<br>   | 5MM    | 24CM   | 52224-26B1        | 52224-26B8  | 52224-26B9  | 52224-26B10  | 52224-26B17  | 52224-26B3    | 52224-26B4  |
|   | 5MM    | 33CM   | 52255-26B1        | 52255-26B8  | 52255-26B9  | 52255-26B10  | 52255-26B17  | 52255-26B3    | 52255-26B4  |
|   | 5MM    | 36CM   | 52236-26B1        | 52236-26B8  | 52236-26B9  | 52236-26B10  | 52236-26B17  | 52236-26B3    | 52236-26B4  |
|   | 5MM    | 45CM   | 52155-26B1        | 52155-26B8  | 52155-26B9  | 52155-26B10  | 52155-26B17  | 52155-26B3    | 52155-26B4  |
| FENESTRATED DBL. FUNDUS GRASPER 16MM TIP<br>  | 5MM    | 24CM   | 52224-226B1       | 52224-226B8 | 52224-226B9 | 52224-226B10 | 52224-226B17 | 52224-226B3   | 52224-226B4 |
|   | 5MM    | 33CM   | 52255-226B1       | 52255-226B8 | 52255-226B9 | 52255-226B10 | 52255-226B17 | 52255-226B3   | 52255-226B4 |
|   | 5MM    | 36CM   | 52236-226B1       | 52236-226B8 | 52236-226B9 | 52236-226B10 | 52236-226B17 | 52236-226B3   | 52236-226B4 |
|   | 5MM    | 45CM   | 52155-226B1       | 52155-226B8 | 52155-226B9 | 52155-226B10 | 52155-226B17 | 52155-226B3   | 52155-226B4 |
| "MCKEARNAN" STYLE FUNDUS GRASPER 16MM TIP<br> | 5MM    | 24CM   | 52224-126B1       | 52224-126B8 | 52224-126B9 | 52224-126B10 | 52224-126B17 | 52224-126B3   | 52224-126B4 |
|   | 5MM    | 33CM   | 52255-126B1       | 52255-126B8 | 52255-126B9 | 52255-126B10 | 52255-126B17 | 52255-126B3   | 52255-126B4 |
|   | 5MM    | 36CM   | 52236-126B1       | 52236-126B8 | 52236-126B9 | 52236-126B10 | 52236-126B17 | 52236-126B3   | 52236-126B4 |
|   | 5MM    | 45CM   | 52155-126B1       | 52155-126B8 | 52155-126B9 | 52155-126B10 | 52155-126B17 | 52155-126B3   | 52155-126B4 |





# 5MM DISSECTORS & GRASPERS



MADE IN THE USA

**BASIN SERIES:**  
ROTATABLE ONE-PIECE INSTRUMENT WITH  
FLUSH PORT

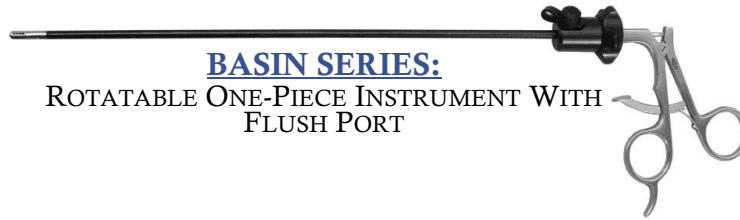

| TIP ID & LENGTH  | HANDLE   |        | TYPE 1            | TYPE 8      | TYPE 9      | TYPE 10      | TYPE 17      | TYPE 3        | TYPE 4      |
|--|----------|--------|-------------------|-------------|-------------|--------------|--------------|---------------|-------------|
|  | DIAMETER | LENGTH |                   |             |             |              |              |               |             |
|  |          |        | INSULATED HANDLES |             |             |              |              | NON-INSULATED |             |
| BLUNT ATRAUMATIC GRASPING FORCEPS, DA 14MM TIP<br>               | 5MM      | 24CM   | 52224-47B1        | 52224-47B8  | 52224-47B9  | 52224-47B10  | 52224-47B17  | 52224-47B3    | 52224-47B4  |
|  | 5MM      | 33CM   | 52255-47B1        | 52255-47B8  | 52255-47B9  | 52255-47B10  | 52255-47B17  | 52255-47B3    | 52255-47B4  |
|  | 5MM      | 36CM   | 52236-47B1        | 52236-47B8  | 52236-47B9  | 52236-47B10  | 52236-47B17  | 52236-47B3    | 52236-47B4  |
|  | 5MM      | 45CM   | 52155-47B1        | 52155-47B8  | 52155-47B9  | 52155-47B10  | 52155-47B17  | 52155-47B3    | 52155-47B4  |
| BLUNT ATRAUMATIC GRASPER W/ CROSS-SERRATED TIPS, DA 14MM TIP<br> | 5MM      | 24CM   | 52224-56B1        | 52224-56B8  | 52224-56B9  | 52224-56B10  | 52224-56B17  | 52224-56B3    | 52224-56B4  |
|  | 5MM      | 33CM   | 52255-56B1        | 52255-56B8  | 52255-56B9  | 52255-56B10  | 52255-56B17  | 52255-56B3    | 52255-56B4  |
|  | 5MM      | 36CM   | 52236-56B1        | 52236-56B8  | 52236-56B9  | 52236-56B10  | 52236-56B17  | 52236-56B3    | 52236-56B4  |
|  | 5MM      | 45CM   | 52155-56B1        | 52155-56B8  | 52155-56B9  | 52155-56B10  | 52155-56B17  | 52155-56B3    | 52155-56B4  |
| BULLET NOSE GRASPER TC, MICRO DIAMOND JAW 15MM TIP<br>           | 5MM      | 24CM   | 52224-48B1        | 52224-48B8  | 52224-48B9  | 52224-48B10  | 52224-48B17  | 52224-48B3    | 52224-48B4  |
|  | 5MM      | 33CM   | 52255-48B1        | 52255-48B8  | 52255-48B9  | 52255-48B10  | 52255-48B17  | 52255-48B3    | 52255-48B4  |
|  | 5MM      | 36CM   | 52236-48B1        | 52236-48B8  | 52236-48B9  | 52236-48B10  | 52236-48B17  | 52236-48B3    | 52236-48B4  |
|  | 5MM      | 45CM   | 52155-48B1        | 52155-48B8  | 52155-48B9  | 52155-48B10  | 52155-48B17  | 52155-48B3    | 52155-48B4  |
| BULLET NOSE GRASPER, TC, CROSS DIAMOND JAW 15MM TIP<br>          | 5MM      | 24CM   | 52224-49B1        | 52224-49B8  | 52224-49B9  | 52224-49B10  | 52224-49B17  | 52224-49B3    | 52224-49B4  |
|  | 5MM      | 33CM   | 52255-49B1        | 52255-49B8  | 52255-49B9  | 52255-49B10  | 52255-49B17  | 52255-49B3    | 52255-49B4  |
|  | 5MM      | 36CM   | 52236-49B1        | 52236-49B8  | 52236-49B9  | 52236-49B10  | 52236-49B17  | 52236-49B3    | 52236-49B4  |
|  | 5MM      | 45CM   | 52155-49B1        | 52155-49B8  | 52155-49B9  | 52155-49B10  | 52155-49B17  | 52155-49B3    | 52155-49B4  |
| LONG TAPERED GRASPER W/ ATRAUMATIC TEETH 20MM TIP<br>            | 5MM      | 24CM   | 52224-51B1        | 52224-51B8  | 52224-51B9  | 52224-51B10  | 52224-51B17  | 52224-51B3    | 52224-51B4  |
|  | 5MM      | 33CM   | 52255-51B1        | 52255-51B8  | 52255-51B9  | 52255-51B10  | 52255-51B17  | 52255-51B3    | 52255-51B4  |
|  | 5MM      | 36CM   | 52236-51B1        | 52236-51B8  | 52236-51B9  | 52236-51B10  | 52236-51B17  | 52236-51B3    | 52236-51B4  |
|  | 5MM      | 45CM   | 52155-51B1        | 52155-51B8  | 52155-51B9  | 52155-51B10  | 52155-51B17  | 52155-51B3    | 52155-51B4  |
| WAVE GRASPER, POINTED, SA 14MM TIP<br>                           | 5MM      | 24CM   | 52224-54B1        | 52224-54B8  | 52224-54B9  | 52224-54B10  | 52224-54B17  | 52224-54B3    | 52224-54B4  |
|  | 5MM      | 33CM   | 52255-54B1        | 52255-54B8  | 52255-54B9  | 52255-54B10  | 52255-54B17  | 52255-54B3    | 52255-54B4  |
|  | 5MM      | 36CM   | 52236-54B1        | 52236-54B8  | 52236-54B9  | 52236-54B10  | 52236-54B17  | 52236-54B3    | 52236-54B4  |
|  | 5MM      | 45CM   | 52155-54B1        | 52155-54B8  | 52155-54B9  | 52155-54B10  | 52155-54B17  | 52155-54B3    | 52155-54B4  |
| "ACCESS" TYPE, FENESTRATED GRASPER 20MM TIP<br>                  | 5MM      | 24CM   | 52224-191B1       | 52224-191B8 | 52224-191B9 | 52224-191B10 | 52224-191B17 | 52224-191B3   | 52224-191B4 |
|  | 5MM      | 33CM   | 52255-191B1       | 52255-191B8 | 52255-191B9 | 52255-191B10 | 52255-191B17 | 52255-191B3   | 52255-191B4 |
|  | 5MM      | 36CM   | 52236-191B1       | 52236-191B8 | 52236-191B9 | 52236-191B10 | 52236-191B17 | 52236-191B3   | 52236-191B4 |
|  | 5MM      | 45CM   | 52155-191B1       | 52155-191B8 | 52155-191B9 | 52155-191B10 | 52155-191B17 | 52155-191B3   | 52155-191B4 |





# 5MM DISSECTORS & GRASPERS



MADE IN THE USA



**BASIN SERIES:**  
ROTATABLE ONE-PIECE INSTRUMENT WITH  
FLUSH PORT

| TIP ID & LENGTH  | HANDLE   |        | TYPE 1            | TYPE 8      | TYPE 9      | TYPE 10      | TYPE 17      | TYPE 3        | TYPE 4      |
|--|----------|--------|-------------------|-------------|-------------|--------------|--------------|---------------|-------------|
|  | DIAMETER | LENGTH |                   |             |             |              |              |               |             |
|  |          |        | INSULATED HANDLES |             |             |              |              | NON-INSULATED |             |
| "SOFT TOUCH" GRASPER, 22MM JAW, TEFLON INSERTS<br>22MM TIP<br> | 5MM      | 24CM   | 52224-144B1       | 52224-144B8 | 52224-144B9 | 52224-144B10 | 52224-144B17 | 52224-144B3   | 52224-144B4 |
|  | 5MM      | 33CM   | 52255-144B1       | 52255-144B8 | 52255-144B9 | 52255-144B10 | 52255-144B17 | 52255-144B3   | 52255-144B4 |
|  | 5MM      | 36CM   | 52236-144B1       | 52236-144B8 | 52236-144B9 | 52236-144B10 | 52236-144B17 | 52236-144B3   | 52236-144B4 |
|  | 5MM      | 45CM   | 52155-144B1       | 52155-144B8 | 52155-144B9 | 52155-144B10 | 52155-144B17 | 52155-144B3   | 52155-144B4 |
| "SOFT TOUCH" GRASPER, 40MM JAW, TEFLON INSERTS<br>40MM TIP<br> | 5MM      | 24CM   | 52224-145B1       | 52224-145B8 | 52224-145B9 | 52224-145B10 | 52224-145B17 | 52224-145B3   | 52224-145B4 |
|  | 5MM      | 33CM   | 52255-145B1       | 52255-145B8 | 52255-145B9 | 52255-145B10 | 52255-145B17 | 52255-145B3   | 52255-145B4 |
|  | 5MM      | 36CM   | 52236-145B1       | 52236-145B8 | 52236-145B9 | 52236-145B10 | 52236-145B17 | 52236-145B3   | 52236-145B4 |
|  | 5MM      | 45CM   | 52155-145B1       | 52155-145B8 | 52155-145B9 | 52155-145B10 | 52155-145B17 | 52155-145B3   | 52155-145B4 |
| TUBAL GRASPER, DA<br>10MM TIP<br>                              | 5MM      | 24CM   | 52224-156B1       | 52224-156B8 | 52224-156B9 | 52224-156B10 | 52224-156B17 | 52224-156B3   | 52224-156B4 |
|  | 5MM      | 33CM   | 52255-156B1       | 52255-156B8 | 52255-156B9 | 52255-156B10 | 52255-156B17 | 52255-156B3   | 52255-156B4 |
|  | 5MM      | 36CM   | 52236-156B1       | 52236-156B8 | 52236-156B9 | 52236-156B10 | 52236-156B17 | 52236-156B3   | 52236-156B4 |
|  | 5MM      | 45CM   | 52155-156B1       | 52155-156B8 | 52155-156B9 | 52155-156B10 | 52155-156B17 | 52155-156B3   | 52155-156B4 |
| "DAVOL" TYPE, SCOOPED- JAW & GENTLY MASH TEETH<br>15MM TIP<br> | 5MM      | 24CM   | 52224-90B1        | 52224-90B8  | 52224-90B9  | 52224-90B10  | 52224-90B17  | 52224-90B3    | 52224-90B4  |
|  | 5MM      | 33CM   | 52255-90B1        | 52255-90B8  | 52255-90B9  | 52255-90B10  | 52255-90B17  | 52255-90B3    | 52255-90B4  |
|  | 5MM      | 36CM   | 52236-90B1        | 52236-90B8  | 52236-90B9  | 52236-90B10  | 52236-90B17  | 52236-90B3    | 52236-90B4  |
|  | 5MM      | 45CM   | 52155-90B1        | 52155-90B8  | 52155-90B9  | 52155-90B10  | 52155-90B17  | 52155-90B3    | 52155-90B4  |
| "DAVOL" TYPE, SCOOPED- JAW & 2 X 3 FRONT TEETH<br>15MM TIP<br> | 5MM      | 24CM   | 52224-190B1       | 52224-190B8 | 52224-190B9 | 52224-190B10 | 52224-190B17 | 52224-190B3   | 52224-190B4 |
|  | 5MM      | 33CM   | 52255-190B1       | 52255-190B8 | 52255-190B9 | 52255-190B10 | 52255-190B17 | 52255-190B3   | 52255-190B4 |
|  | 5MM      | 36CM   | 52236-190B1       | 52236-190B8 | 52236-190B9 | 52236-190B10 | 52236-190B17 | 52236-190B3   | 52236-190B4 |
|  | 5MM      | 45CM   | 52155-190B1       | 52155-190B8 | 52155-190B9 | 52155-190B10 | 52155-190B17 | 52155-190B3   | 52155-190B4 |
| DEBAKEY GRASPER, SA<br>22MM TIP<br>                            | 5MM      | 24CM   | 52224-122B1       | 52224-122B8 | 52224-122B9 | 52224-122B10 | 52224-122B17 | 52224-122B3   | 52224-122B4 |
|  | 5MM      | 33CM   | 52255-122B1       | 52255-122B8 | 52255-122B9 | 52255-122B10 | 52255-122B17 | 52255-122B3   | 52255-122B4 |
|  | 5MM      | 36CM   | 52236-122B1       | 52236-122B8 | 52236-122B9 | 52236-122B10 | 52236-122B17 | 52236-122B3   | 52236-122B4 |
|  | 5MM      | 45CM   | 52155-122B1       | 52155-122B8 | 52155-122B9 | 52155-122B10 | 52155-122B17 | 52155-122B3   | 52155-122B4 |





# 5MM SCISSORS & BIOPSY FORCEPS



MADE IN THE USA



## BASIN SERIES:

ROTATABLE ONE-PIECE INSTRUMENT WITH FLUSH PORT

| TIP ID & LENGTH   | HANDLE   |        | TYPE 1            | TYPE 5      | TYPE 9      | TYPE 17      | TYPE 23      | TYPE 3        | TYPE 16      |
|---|----------|--------|-------------------|-------------|-------------|--------------|--------------|---------------|--------------|
|   | DIAMETER | LENGTH |                   |             |             |              |              |               |              |
|   |          |        | INSULATED HANDLES |             |             |              |              | NON-INSULATED |              |
| HOOK SCISSORS, SA<br>10MM TIP<br>                                     | 5MM      | 24CM   | 52224-60B1        | 52224-60B8  | 52224-60B9  | 52224-60B17  | 52224-60B23  | 52224-60B3    | 52224-60B16  |
|   | 5MM      | 33CM   | 52255-60B1        | 52255-60B8  | 52255-60B9  | 52255-60B17  | 52255-60B23  | 52255-60B3    | 52255-60B16  |
|   | 5MM      | 36CM   | 52236-60B1        | 52236-60B8  | 52236-60B9  | 52236-60B17  | 52236-60B23  | 52236-60B3    | 52236-60B16  |
|   | 5MM      | 45CM   | 52155-60B1        | 52155-60B8  | 52155-60B9  | 52155-60B17  | 52155-60B23  | 52155-60B3    | 52155-60B16  |
| MICRO TIP<br>SCISSORS,<br>STRAIGHT, SA<br>5MM TIP<br>                 | 5MM      | 24CM   | 52224-61B1        | 52224-61B8  | 52224-61B9  | 52224-61B17  | 52224-61B23  | 52224-61B3    | 52224-61B16  |
|   | 5MM      | 33CM   | 52255-61B1        | 52255-61B8  | 52255-61B9  | 52255-61B17  | 52255-61B23  | 52255-61B3    | 52255-61B16  |
|   | 5MM      | 36CM   | 52236-61B1        | 52236-61B8  | 52236-61B9  | 52236-61B17  | 52236-61B23  | 52236-61B3    | 52236-61B16  |
|   | 5MM      | 45CM   | 52155-61B1        | 52155-61B8  | 52155-61B9  | 52155-61B17  | 52155-61B23  | 52155-61B3    | 52155-61B16  |
| MICRO TIP<br>SCISSORS,<br>CURVED, SA<br>5MM TIP<br>                   | 5MM      | 24CM   | 52224-62B1        | 52224-62B8  | 52224-62B9  | 52224-62B17  | 52224-62B23  | 52224-62B3    | 52224-62B16  |
|   | 5MM      | 33CM   | 52255-62B1        | 52255-62B8  | 52255-62B9  | 52255-62B17  | 52255-62B23  | 52255-62B3    | 52255-62B16  |
|   | 5MM      | 36CM   | 52236-62B1        | 52236-62B8  | 52236-62B9  | 52236-62B17  | 52236-62B23  | 52236-62B3    | 52236-62B16  |
|   | 5MM      | 45CM   | 52155-62B1        | 52155-62B8  | 52155-62B9  | 52155-62B17  | 52155-62B23  | 52155-62B3    | 52155-62B16  |
| METZENBAUM<br>SCISSORS,<br>STRAIGHT, LONG<br>BLADE<br>20MM TIP<br>    | 5MM      | 24CM   | 52224-63B1        | 52224-63B8  | 52224-63B9  | 52224-63B17  | 52224-63B23  | 52224-63B3    | 52224-63B16  |
|   | 5MM      | 33CM   | 52255-63B1        | 52255-63B8  | 52255-63B9  | 52255-63B17  | 52255-63B23  | 52255-63B3    | 52255-63B16  |
|   | 5MM      | 36CM   | 52236-63B1        | 52236-63B8  | 52236-63B9  | 52236-63B17  | 52236-63B23  | 52236-63B3    | 52236-63B16  |
|   | 5MM      | 45CM   | 52155-63B1        | 52155-63B8  | 52155-63B9  | 52155-63B17  | 52155-63B23  | 52155-63B3    | 52155-63B16  |
| METZENBAUM<br>SCISSORS,<br>STRAIGHT, SHORT<br>BLADE<br>12MM TIP<br>   | 5MM      | 24CM   | 52224-64B1        | 52224-64B8  | 52224-64B9  | 52224-64B17  | 52224-64B23  | 52224-64B3    | 52224-64B16  |
|   | 5MM      | 33CM   | 52255-64B1        | 52255-64B8  | 52255-64B9  | 52255-64B17  | 52255-64B23  | 52255-64B3    | 52255-64B16  |
|   | 5MM      | 36CM   | 52236-64B1        | 52236-64B8  | 52236-64B9  | 52236-64B17  | 52236-64B23  | 52236-64B3    | 52236-64B16  |
|   | 5MM      | 45CM   | 52155-64B1        | 52155-64B8  | 52155-64B9  | 52155-64B17  | 52155-64B23  | 52155-64B3    | 52155-64B16  |
| METZENBAUM<br>SCISSORS,<br>CURVED, LONG<br>BLADE<br>16MM TIP<br>      | 5MM      | 24CM   | 52224-65B1        | 52224-65B8  | 52224-65B9  | 52224-65B17  | 52224-65B23  | 52224-65B3    | 52224-65B16  |
|   | 5MM      | 33CM   | 52255-65B1        | 52255-65B8  | 52255-65B9  | 52255-65B17  | 52255-65B23  | 52255-65B3    | 52255-65B16  |
|   | 5MM      | 36CM   | 52236-65B1        | 52236-65B8  | 52236-65B9  | 52236-65B17  | 52236-65B23  | 52236-65B3    | 52236-65B16  |
|   | 5MM      | 45CM   | 52155-65B1        | 52155-65B8  | 52155-65B9  | 52155-65B17  | 52155-65B23  | 52155-65B3    | 52155-65B16  |
| METZENBAUM<br>SCISSORS,<br>WONDERCUT,<br>CURVED BLADE<br>20MM TIP<br> | 5MM      | 24CM   | 52224-265B1       | 52224-265B8 | 52224-265B9 | 52224-265B17 | 52224-265B23 | 52224-265B3   | 52224-265B16 |
|   | 5MM      | 33CM   | 52255-265B1       | 52255-265B8 | 52255-265B9 | 52255-265B17 | 52255-265B23 | 52255-265B3   | 52255-265B16 |
|   | 5MM      | 36CM   | 52236-265B1       | 52236-265B8 | 52236-265B9 | 52236-265B17 | 52236-265B23 | 52236-265B3   | 52236-265B16 |
|   | 5MM      | 45CM   | 52155-265B1       | 52155-265B8 | 52155-265B9 | 52155-265B17 | 52155-265B23 | 52155-265B3   | 52155-265B16 |





# 5MM SCISSORS & BIOPSY FORCEPS



MADE IN THE USA

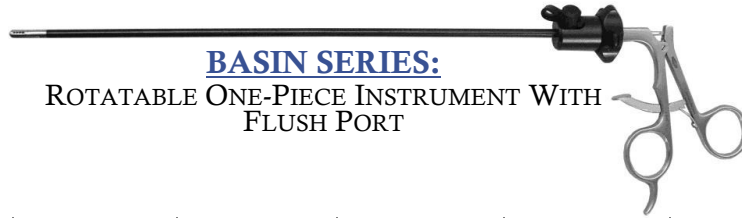

**BASIN SERIES:**  
ROTATABLE ONE-PIECE INSTRUMENT WITH  
FLUSH PORT

| TIP ID & LENGTH   | HANDLE   |        | TYPE 1            | TYPE 5      | TYPE 9      | TYPE 17      | TYPE 23      | TYPE 3        | TYPE 16      |
|---|----------|--------|-------------------|-------------|-------------|--------------|--------------|---------------|--------------|
|   | DIAMETER | LENGTH |                   |             |             |              |              |               |              |
|   |          |        | INSULATED HANDLES |             |             |              |              | NON-INSULATED |              |
| <b>METZENBAUM SCISSORS, CURVED, SHORT BLADE 12MM TIP</b><br>        | 5MM      | 24CM   | 52224-66B1        | 52224-66B8  | 52224-66B9  | 52224-66B17  | 52224-66B23  | 52224-66B3    | 52224-66B16  |
|   | 5MM      | 33CM   | 52255-66B1        | 52255-66B8  | 52255-66B9  | 52255-66B17  | 52255-66B23  | 52255-66B3    | 52255-66B16  |
|   | 5MM      | 36CM   | 52236-66B1        | 52236-66B8  | 52236-66B9  | 52236-66B17  | 52236-66B23  | 52236-66B3    | 52236-66B16  |
|   | 5MM      | 45CM   | 52155-66B1        | 52155-66B8  | 52155-66B9  | 52155-66B17  | 52155-66B23  | 52155-66B3    | 52155-66B16  |
| <b>PERITONEAL SCISSORS, SA 15MM TIP</b><br>                         | 5MM      | 24CM   | 52224-67B1        | 52224-67B8  | 52224-67B9  | 52224-67B17  | 52224-67B23  | 52224-67B3    | 52224-67B16  |
|   | 5MM      | 33CM   | 52255-67B1        | 52255-67B8  | 52255-67B9  | 52255-67B17  | 52255-67B23  | 52255-67B3    | 52255-67B16  |
|   | 5MM      | 36CM   | 52236-67B1        | 52236-67B8  | 52236-67B9  | 52236-67B17  | 52236-67B23  | 52236-67B3    | 52236-67B16  |
|   | 5MM      | 45CM   | 52155-67B1        | 52155-67B8  | 52155-67B9  | 52155-67B17  | 52155-67B23  | 52155-67B3    | 52155-67B16  |
| <b>BIOPSY SPOON FORCEPS W/ TOOTH 10MM TIP</b><br>                   | 5MM      | 24CM   | 52224-79B1        | 52224-79B8  | 52224-79B9  | 52224-79B17  | 52224-79B23  | 52224-79B3    | 52224-79B16  |
|   | 5MM      | 33CM   | 52255-79B1        | 52255-79B8  | 52255-79B9  | 52255-79B17  | 52255-79B23  | 52255-79B3    | 52255-79B16  |
|   | 5MM      | 36CM   | 52236-79B1        | 52236-79B8  | 52236-79B9  | 52236-79B17  | 52236-79B23  | 52236-79B3    | 52236-79B16  |
|   | 5MM      | 45CM   | 52155-79B1        | 52155-79B8  | 52155-79B9  | 52155-79B17  | 52155-79B23  | 52155-79B3    | 52155-79B16  |
| <b>BIOPSY SPOON FORCEPS, SHORT, SA 10MM TIP</b><br>                 | 5MM      | 24CM   | 52224-69B1        | 52224-69B8  | 52224-69B9  | 52224-69B17  | 52224-69B23  | 52224-69B3    | 52224-69B16  |
|   | 5MM      | 33CM   | 52255-69B1        | 52255-69B8  | 52255-69B9  | 52255-69B17  | 52255-69B23  | 52255-69B3    | 52255-69B16  |
|   | 5MM      | 36CM   | 52236-69B1        | 52236-69B8  | 52236-69B9  | 52236-69B17  | 52236-69B23  | 52236-69B3    | 52236-69B16  |
|   | 5MM      | 45CM   | 52155-69B1        | 52155-69B8  | 52155-69B9  | 52155-69B17  | 52155-69B23  | 52155-69B3    | 52155-69B16  |
| <b>POINTED BIOPSY SPOON FORCEPS, SA 10MM TIP</b><br>                | 5MM      | 24CM   | 52224-305B1       | 52224-305B8 | 52224-305B9 | 52224-305B17 | 52224-305B23 | 52224-305B3   | 52224-305B16 |
|   | 5MM      | 33CM   | 52255-305B1       | 52255-305B8 | 52255-305B9 | 52255-305B17 | 52255-305B23 | 52255-305B3   | 52255-305B16 |
|   | 5MM      | 36CM   | 52236-305B1       | 52236-305B8 | 52236-305B9 | 52236-305B17 | 52236-305B23 | 52236-305B3   | 52236-305B16 |
|   | 5MM      | 45CM   | 52155-305B1       | 52155-305B8 | 52155-305B9 | 52155-305B17 | 52155-305B23 | 52155-305B3   | 52155-305B16 |
| <b>BIOPSY SPOON FORCEPS, DA 10MM TIP</b><br>                        | 5MM      | 24CM   | 52224-70B1        | 52224-70B8  | 52224-70B9  | 52224-70B17  | 52224-70B23  | 52224-70B3    | 52224-70B16  |
|   | 5MM      | 33CM   | 52255-70B1        | 52255-70B8  | 52255-70B9  | 52255-70B17  | 52255-70B23  | 52255-70B3    | 52255-70B16  |
|   | 5MM      | 36CM   | 52236-70B1        | 52236-70B8  | 52236-70B9  | 52236-70B17  | 52236-70B23  | 52236-70B3    | 52236-70B16  |
|   | 5MM      | 45CM   | 52155-70B1        | 52155-70B8  | 52155-70B9  | 52155-70B17  | 52155-70B23  | 52155-70B3    | 52155-70B16  |
| <b>BIOPSY SPOON FORCEPS, W/ TOOTH (SEMM-TYPE), D/A 10MM TIP</b><br> | 5MM      | 24CM   | 52224-68B1        | 52224-68B8  | 52224-68B9  | 52224-68B17  | 52224-68B23  | 52224-68B3    | 52224-68B16  |
|   | 5MM      | 33CM   | 52255-68B1        | 52255-68B8  | 52255-68B9  | 52255-68B17  | 52255-68B23  | 52255-68B3    | 52255-68B16  |
|   | 5MM      | 36CM   | 52236-68B1        | 52236-68B8  | 52236-68B9  | 52236-68B17  | 52236-68B23  | 52236-68B3    | 52236-68B16  |
|   | 5MM      | 45CM   | 52155-68B1        | 52155-68B8  | 52155-68B9  | 52155-68B17  | 52155-68B23  | 52155-68B3    | 52155-68B16  |





# 5MM SCISSORS & BIOPSY FORCEPS





MADE IN THE USA



## BASIN SERIES:

ROTATABLE ONE-PIECE INSTRUMENT WITH FLUSH PORT

| TIP ID & LENGTH  | HANDLE ID |        | TYPE 1            | TYPE 5     | TYPE 9     | TYPE 17     | TYPE 23     | TYPE 3                | TYPE 16     |
|--|-----------|--------|-------------------|------------|------------|-------------|-------------|-----------------------|-------------|
|  | DIAMETER  | LENGTH |                   |            |            |             |             |                       |             |
|  |           |        | INSULATED HANDLES |            |            |             |             | NON-INSULATED HANDLES |             |
| BIOPSY PUNCH, SA<br>10MM TIP<br>               | 5MM       | 24CM   | 52224-71B1        | 52224-71B8 | 52224-71B9 | 52224-71B17 | 52224-71B23 | 52224-71B3            | 52224-71B16 |
|  | 5MM       | 33CM   | 52255-71B1        | 52255-71B8 | 52255-71B9 | 52255-71B17 | 52255-71B23 | 52255-71B3            | 52255-71B16 |
|  | 5MM       | 36CM   | 52236-71B1        | 52236-71B8 | 52236-71B9 | 52236-71B17 | 52236-71B23 | 52236-71B3            | 52236-71B16 |
|  | 5MM       | 45CM   | 52155-71B1        | 52155-71B8 | 52155-71B9 | 52155-71B17 | 52155-71B23 | 52155-71B3            | 52155-71B16 |
| BIOPSY PUNCH<br>W/ TOOTH, SA<br>10MM TIP<br> | 5MM       | 24CM   | 52224-72B1        | 52224-72B8 | 52224-72B9 | 52224-72B17 | 52224-72B23 | 52224-72B3            | 52224-72B16 |
|  | 5MM       | 33CM   | 52255-72B1        | 52255-72B8 | 52255-72B9 | 52255-72B17 | 52255-72B23 | 52255-72B3            | 52255-72B16 |
|  | 5MM       | 36CM   | 52236-72B1        | 52236-72B8 | 52236-72B9 | 52236-72B17 | 52236-72B23 | 52236-72B3            | 52236-72B16 |
|  | 5MM       | 45CM   | 52155-72B1        | 52155-72B8 | 52155-72B9 | 52155-72B17 | 52155-72B23 | 52155-72B3            | 52155-72B16 |





# 10MM DISSECTORS & GRASPERS



MADE IN THE USA



**BASIN SERIES:**  
ROTATABLE ONE-PIECE INSTRUMENT WITH FLUSH PORT

| TIP ID & LENGTH   | HANDLE ID |        | TYPE 1            | TYPE 8     | TYPE 9     | TYPE 10     | TYPE 17     | TYPE 3        | TYPE 4     |
|---|-----------|--------|-------------------|------------|------------|-------------|-------------|---------------|------------|
|   | DIAMETER  | LENGTH |                   |            |            |             |             |               |            |
|   |           |        | INSULATED HANDLES |            |            |             |             | NON-INSULATED |            |
| <b>MARYLAND DISSECTOR</b><br>18MM TIP<br>                       | 10MM      | 33CM   | 52102-06B1        | 52102-06B8 | 52102-06B9 | 52102-06B10 | 52102-06B17 | 52102-06B3    | 52102-06B4 |
|   | 10MM      | 36CM   | 52103-06B1        | 52103-06B8 | 52103-06B9 | 52103-06B10 | 52103-06B17 | 52103-06B3    | 52103-06B4 |
|   | 10MM      | 45CM   | 52101-06B1        | 52101-06B8 | 52101-06B9 | 52101-06B10 | 52101-06B17 | 52101-06B3    | 52101-06B4 |
| <b>RIGHT ANGLE MIXTER LONG</b><br>TEFON INSERTS<br>22MM TIP<br> | 10MM      | 33CM   | 52102-07B1        | 52102-07B8 | 52102-07B9 | 52102-07B10 | 52102-07B17 | 52102-07B3    | 52102-07B4 |
|   | 10MM      | 36CM   | 52103-07B1        | 52103-07B8 | 52103-07B9 | 52103-07B10 | 52103-07B17 | 52103-07B3    | 52103-07B4 |
|   | 10MM      | 45CM   | 52101-07B1        | 52101-07B8 | 52101-07B9 | 52101-07B10 | 52101-07B17 | 52101-07B3    | 52101-07B4 |
| <b>RIGHT ANGLE MIXTER, SHORT</b><br>12MM TIP<br>                | 10MM      | 33CM   | 52102-59B1        | 52102-59B8 | 52102-59B9 | 52102-59B10 | 52102-59B17 | 52102-59B3    | 52102-59B4 |
|   | 10MM      | 36CM   | 52103-59B1        | 52103-59B8 | 52103-59B9 | 52103-59B10 | 52103-59B17 | 52103-59B3    | 52103-59B4 |
|   | 10MM      | 45CM   | 52101-59B1        | 52101-59B8 | 52101-59B9 | 52101-59B10 | 52101-59B17 | 52101-59B3    | 52101-59B4 |
| <b>45° ANGLED MIXTER</b><br>20MM TIP<br>                        | 10MM      | 33CM   | 52102-08B1        | 52102-08B8 | 52102-08B9 | 52102-08B10 | 52102-08B17 | 52102-08B3    | 52102-08B4 |
|   | 10MM      | 36CM   | 52103-08B1        | 52103-08B8 | 52103-08B9 | 52103-08B10 | 52103-08B17 | 52103-08B3    | 52103-08B4 |
|   | 10MM      | 45CM   | 52101-08B1        | 52101-08B8 | 52101-08B9 | 52101-08B10 | 52101-08B17 | 52101-08B3    | 52101-08B4 |
| <b>BABCOCK GRASPER</b><br>FENESTRATED TIP<br>30MM TIP<br>       | 10MM      | 33CM   | 52102-16A1        | 52102-16B8 | 52102-16B9 | 52102-16B10 | 52102-16B17 | 52102-16B3    | 52102-16B4 |
|   | 10MM      | 36CM   | 52103-16B1        | 52103-16B8 | 52103-16B9 | 52103-16B10 | 52103-16B17 | 52103-16B3    | 52103-16B4 |
|   | 10MM      | 45CM   | 52101-16B1        | 52101-16B8 | 52101-16B9 | 52101-16B10 | 52101-16B17 | 52101-16B3    | 52101-16B4 |
| <b>ALLIS GRASPER</b><br>STD VERSION<br>30MM TIP<br>             | 10MM      | 33CM   | 52102-21B1        | 52102-21B8 | 52102-21B9 | 52102-21B10 | 52102-21B17 | 52102-21B3    | 52102-21B4 |
|   | 10MM      | 36CM   | 52103-21B1        | 52103-21B8 | 52103-21B9 | 52103-21B10 | 52103-21B17 | 52103-21B3    | 52103-21B4 |
|   | 10MM      | 45CM   | 52101-21B1        | 52101-21B8 | 52101-21B9 | 52101-21B10 | 52101-21B17 | 52101-21B3    | 52101-21B4 |
| <b>DEBAKEY GRASPER</b><br>40MM TIP<br>                          | 10MM      | 33CM   | 52102-22B1        | 52102-22B8 | 52102-22B9 | 52102-22B10 | 52102-22B17 | 52102-22B3    | 52102-22B4 |
|   | 10MM      | 36CM   | 52103-22B1        | 52103-22B8 | 52103-22B9 | 52103-22B10 | 52103-22B17 | 52103-22B3    | 52103-22B4 |
|   | 10MM      | 45CM   | 52101-22B1        | 52101-22B8 | 52101-22B9 | 52101-22B10 | 52101-22B17 | 52101-22B3    | 52101-22B4 |
| <b>DEBAKEY GRASPER</b><br>60MM TIP<br>                          | 10MM      | 33CM   | 52102-23B1        | 52102-23B8 | 52102-23B9 | 52102-23B10 | 52102-23B17 | 52102-23B3    | 52102-23B4 |
|   | 10MM      | 36CM   | 52103-23B1        | 52103-23B8 | 52103-23B9 | 52103-23B10 | 52103-23B17 | 52103-23B3    | 52103-23B4 |
|   | 10MM      | 45CM   | 52101-23B1        | 52101-23B8 | 52101-23B9 | 52101-23B10 | 52101-23B17 | 52101-23B3    | 52101-23B4 |
| <b>CLAW GRASPER,</b><br>2 X 3 TEETH, SA<br>20MM TIP<br>         | 10MM      | 33CM   | 52102-36B1        | 52102-36B8 | 52102-36B9 | 52102-36B10 | 52102-36B17 | 52102-36B3    | 52102-36B4 |
|   | 10MM      | 36CM   | 52103-36B1        | 52103-36B8 | 52103-36B9 | 52103-36B10 | 52103-36B17 | 52103-36B3    | 52103-36B4 |
|   | 10MM      | 45CM   | 52101-36B1        | 52101-36B8 | 52101-36B9 | 52101-36B10 | 52101-36B17 | 52101-36B3    | 52101-36B4 |





# 10MM DISSECTORS & GRASPERS



MADE IN THE USA



**BASIN SERIES:**  
ROTATABLE ONE-PIECE INSTRUMENT WITH  
FLUSH PORT

| TIP ID & LENGTH                                     | HANDLE   |        | TYPE 1            | TYPE 8     | TYPE 9     | TYPE 10     | TYPE 17     | TYPE 3        | TYPE 4     |
|---|----------|--------|-------------------|------------|------------|-------------|-------------|---------------|------------|
|   | DIAMETER | LENGTH |                   |            |            |             |             |               |            |
|   |          |        | INSULATED HANDLES |            |            |             |             | NON-INSULATED |            |
| SCHROEDER TEN, SINGLE TOOTH 25MM TIP<br>            | 10MM     | 33CM   | 52102-45B1        | 52102-45B8 | 52102-45B9 | 52102-45B10 | 52102-45B17 | 52102-45B3    | 52102-45B4 |
|   | 10MM     | 36CM   | 52103-45B1        | 52103-45B8 | 52103-45B9 | 52103-45B10 | 52103-45B17 | 52103-45B3    | 52103-45B4 |
|   | 10MM     | 45CM   | 52101-45B1        | 52101-45B8 | 52101-45B9 | 52101-45B10 | 52101-45B17 | 52101-45B3    | 52101-45B4 |
| US BABCOCK, SPRING TENSION, ATRAUMATIC 22MM TIP<br> | 10MM     | 33CM   | 52102-17B1        | 52102-17B8 | 52102-17B9 | 52102-17B10 | 52102-17B17 | 52102-17B3    | 52102-17B4 |
|   | 10MM     | 36CM   | 52103-17B1        | 52103-17B8 | 52103-17B9 | 52103-17B10 | 52103-17B17 | 52103-17B3    | 52103-17B4 |
|   | 10MM     | 45CM   | 52101-17B1        | 52101-17B8 | 52101-17B9 | 52101-17B10 | 52101-17B17 | 52101-17B3    | 52101-17B4 |
| DUVAL GRASPER, AXIAL SERRATIONS 40MM TIP<br>        | 10MM     | 33CM   | 52102-26B1        | 52102-26B8 | 52102-26B9 | 52102-26B10 | 52102-26B17 | 52102-26B3    | 52102-26B4 |
|   | 10MM     | 36CM   | 52103-26B1        | 52103-26B8 | 52103-26B9 | 52103-26B10 | 52103-26B17 | 52103-26B3    | 52103-26B4 |
|   | 10MM     | 45CM   | 52101-26B1        | 52101-26B8 | 52101-26B9 | 52101-26B10 | 52101-26B17 | 52101-26B3    | 52101-26B4 |
| STRONG ATRAUMATIC CLAMP, STRAIGHT JAW, 40MM TIP<br> | 10MM     | 33CM   | 52102-46B1        | 52102-46B8 | 52102-46B9 | 52102-46B10 | 52102-46B17 | 52102-46B3    | 52102-46B4 |
|   | 10MM     | 36CM   | 52103-46B1        | 52103-46B8 | 52103-46B9 | 52103-46B10 | 52103-46B17 | 52103-46B3    | 52103-46B4 |
|   | 10MM     | 45CM   | 52101-46B1        | 52101-46B8 | 52101-46B9 | 52101-46B10 | 52101-46B17 | 52101-46B3    | 5210-46B4  |
| STRONG ATRAUMATIC CLAMP, CURVED JAW, 40MM TIP<br>   | 10MM     | 33CM   | 52102-47B1        | 52102-47B8 | 52102-47B9 | 52102-47B10 | 52102-47B17 | 52102-47B3    | 52102-47B4 |
|   | 10MM     | 36CM   | 52103-47B1        | 52103-47B8 | 52103-47B9 | 52103-47B10 | 52103-47B17 | 52103-47B3    | 52103-47B4 |
|   | 10MM     | 45CM   | 52101-47B1        | 52101-47B8 | 52101-47B9 | 52101-47B10 | 52101-47B17 | 52101-47B3    | 5210-47B4  |
| ANVIL GRAPER TO GRASP & HOLD ANVIL, 10MM TIP<br>    | 10MM     | 33CM   | 52102-20B1        | 52102-20B8 | 52102-20B9 | 52102-20B10 | 52102-20B17 | 52102-20B3    | 52102-20B4 |
|   | 10MM     | 36CM   | 52103-20B1        | 52103-20B8 | 52103-20B9 | 52103-20B10 | 52103-20B17 | 52103-20B3    | 52103-20B4 |
|   | 10MM     | 45CM   | 52101-20B1        | 52101-20B8 | 52101-20B9 | 52101-20B10 | 52101-20B17 | 52101-20B3    | 5210-20B4  |





# 10MM SCISSORS & BIOPSY FORCEPS



MADE IN THE USA



## BASIN SERIES:

ROTATABLE ONE-PIECE INSTRUMENT WITH FLUSH PORT

| TIP ID & LENGTH                               | HANDLE ID |        | TYPE 1            | TYPE 5     | TYPE 9     | TYPE 17     | TYPE 23     | TYPE 3        | TYPE 16     |
|---|-----------|--------|-------------------|------------|------------|-------------|-------------|---------------|-------------|
|   | DIAMETER  | LENGTH |                   |            |            |             |             |               |             |
|   |           |        | INSULATED HANDLES |            |            |             |             | NON-INSULATED |             |
| STRAIGHT SCISSORS, SA<br>20MM TIP<br>         | 10MM      | 33CM   | 52102-64B1        | 52102-64B5 | 52102-64B9 | 52102-64B17 | 52102-64B23 | 52102-64B3    | 52102-64B16 |
|   | 10MM      | 36CM   | 52103-64B1        | 52103-64B5 | 52103-64B9 | 52103-64B17 | 52103-64B23 | 52103-64B3    | 52103-64B16 |
|   | 10MM      | 45CM   | 52101-64B1        | 52101-64B5 | 52101-64B9 | 52101-64B17 | 52101-64B23 | 52101-64B3    | 52101-64B16 |
| CURVED SCISSORS, DA<br>20MM TIP<br>           | 10MM      | 33CM   | 52102-66B1        | 52102-66B5 | 52102-66B9 | 52102-66B17 | 52102-66B23 | 52102-66B3    | 52102-66B16 |
|   | 10MM      | 36CM   | 52103-66B1        | 52103-66B5 | 52103-66B9 | 52103-66B17 | 52103-66B23 | 52103-66B3    | 52103-66B16 |
|   | 10MM      | 45CM   | 52101-66B1        | 52101-66B5 | 52101-66B9 | 52101-66B17 | 52101-66B23 | 52101-66B3    | 52101-66B16 |
| BIOPSY SPOON FORCEPS, SHORT, SA, 10MM TIP<br> | 10MM      | 33CM   | 52102-37B1        | 52102-37B5 | 52102-37B9 | 52102-37B17 | 52102-37B23 | 52102-37B3    | 52102-37B16 |
|   | 10MM      | 36CM   | 52103-37B1        | 52103-37B5 | 52103-37B9 | 52103-37B17 | 52103-37B23 | 52103-37B3    | 52103-37B16 |
|   | 10MM      | 45CM   | 52101-37B1        | 52101-37B5 | 52101-37B9 | 52101-37B17 | 52101-37B23 | 52101-37B3    | 52101-37B16 |
| BIOPSY SPOON FORCEPS, LONG, SA, 25MM TIP<br>  | 10MM      | 33CM   | 52102-38B1        | 52102-38B5 | 52102-38B9 | 52102-38B17 | 52102-38B23 | 52102-38B3    | 52102-38B16 |
|   | 10MM      | 36CM   | 52103-38B1        | 52103-38B5 | 52103-38B9 | 52103-38B17 | 52103-38B23 | 52103-38B3    | 52103-38B16 |
|   | 10MM      | 45CM   | 52101-38B1        | 52101-38B5 | 52101-38B9 | 52101-38B17 | 52101-38B23 | 52101-38B3    | 52101-38B16 |



# SUMMIT SERIES



THE *SUMMIT SERIES* 5MM MODULAR, THREE-PIECE DETACHABLE INSTRUMENTS IS OUR MOST EXTENSIVE LINE OF LAPAROSCOPIC INSTRUMENTS, OFFERING OVER 2000 DIFFERENT COMBINATIONS FOR THE MOST PRECISE INSTRUMENTATION NEEDED FOR ANY PROCEDURE. OUR THREE-PIECE MODULAR INSTRUMENTS ARE DESIGNED TO COME APART FOR SUPERIOR CLEANING.

THEY ARE ALSO COMPLETELY INTERCHANGEABLE WITH ANY OF OUR LAPAROSCOPIC HANDLES GIVING HOSPITALS & SURGERY CENTERS THE FLEXIBILITY TO QUICKLY ASSEMBLE INSTRUMENTS WITHOUT HAVING TO MATCH UP EVERY INSERT, SHAFT, & HANDLE.

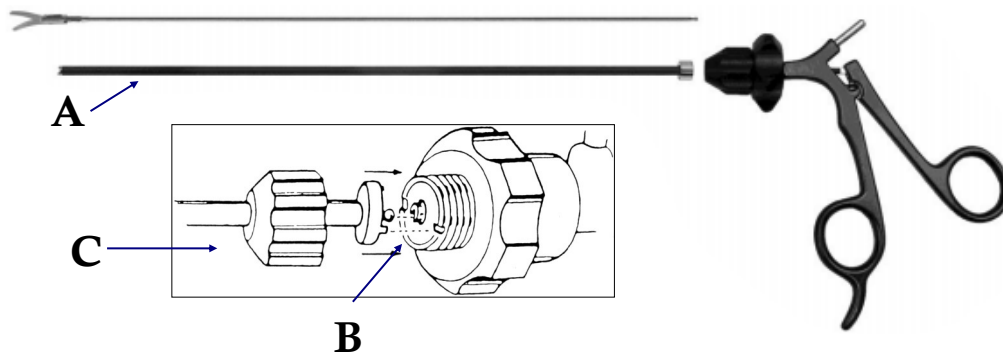

### **ASSEMBLY:**

1. TURN THE **TIP (C)** CLOCKWISE INTO THE SHAFT
2. SET THE HANDLE IN THE OPEN POSITION & ENGAGE THE **BALL (B)** OF **INNER ROD** INTO ITS FIXATION IN THE HANDLE PORT.
3. TURN MAIN **SCREW CAP (A)** CLOCKWISE UNTIL IT ENGAGES THE HANDLE.



# SUMMIT SERIES OUTER TUBES & ACCESSORIES



MADE IN THE USA



## 5MM INSULATED SHAFT

| ITEM NO.        | DESCRIPTION |
|-----------------|-------------|
| <b>52555-49</b> | 5MM X 24CM  |
| <b>52555-45</b> | 5MM X 33CM  |
| <b>52555-39</b> | 5MM X 36CM  |
| <b>52555-47</b> | 5MM X 45CM  |



**52555-47-01**

SHAFT LOCKING  
CAP

## 5MM NON-INSULATED SHAFT

| ITEM NO.        | DESCRIPTION |
|-----------------|-------------|
| <b>52555-32</b> | 5MM X 24CM  |
| <b>52555-51</b> | 5MM X 33CM  |
| <b>52555-34</b> | 5MM X 36CM  |
| <b>52555-35</b> | 5MM X 45CM  |

## REUSABLE CABLES FOR MONOPOLAR INSTRUMENTS & GENERATORS



GENERATOR



INSTRUMENT END

**52005-31**

4MM DIA. PLUG (UNIT) &  
4MM DIA. FEMALE INST. PLUG



## 10MM INSULATED SHAFT

| ITEM NO.        | DESCRIPTION |
|-----------------|-------------|
| <b>52555-50</b> | 10MM X 24CM |
| <b>52555-46</b> | 10MM X 33CM |
| <b>52555-56</b> | 10MM X 36CM |
| <b>52555-48</b> | 10MM X 45CM |



GENERATOR



INSTRUMENT END

**52005-32**

8MM DIA. "BOVIE" PLUG  
(UNIT) & 4MM DIA. FEMALE  
INST. PLUG

## 10MM NON-INSULATED SHAFT

| ITEM NO.        | DESCRIPTION |
|-----------------|-------------|
| <b>52555-55</b> | 10MM X 24CM |
| <b>52555-52</b> | 10MM X 33CM |
| <b>52555-53</b> | 10MM X 36CM |
| <b>52555-54</b> | 10M X 45CM  |





# HANDLES: INSULATED & CARBON FIBER



MADE IN THE USA

## 52555-40-01

INSULATED STAINLESS STEEL W/ RF POST  
(TYPE 1)



## 52555-40-02

INSULATED STAINLESS STEEL W/ RF-POST  
& RATCHET  
(TYPE 2)

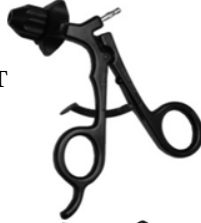

## 52555-40-05

INSULATED W/ RF-POST & RATCHET  
(TYPE 5)



## 52555-40-06

LIGHTWEIGHT CARBON FIBER W/ RF-POST  
& ON DEMAND ON/OFF RATCHET  
(TYPE 6)



## 52555-40-07

LIGHTWEIGHT CARBON-FIBER W/ RF POST,  
RATCHET / RATCHET  
DEFEATING (TYPE 7)



## 52555-40-08

LIGHTWEIGHT CARBON-FIBER W/ RF POST,  
ON DEMAND FRENCH ON/OFF RATCHET  
(TYPE 8)



## 52555-40-09

LIGHTWEIGHT CARBON-FIBER W/ RF POST,  
W/ LARGE FINGER LOOPS  
(TYPE 9)



## 52555-40-10

LIGHTWEIGHT CARBON-FIBER W/ RF POST,  
RATCHET/RATCHET DEFEATING W/ LARGE  
FINGER LOOPS  
(TYPE 10)



## 52555-40-14

INSULATED STAINLESS STEEL LINVATEC-  
WECK STYLE W/ LONG SHANKS  
(TYPE 14)



## 52555-40-17

LIGHTWEIGHT CARBON FIBER W/ RF POST  
(TYPE 17)



## 52555-40-18

LIGHTWEIGHT CARBON-FIBER W/ RF POST,  
RATCHET / RATCHET DEFEATING  
(TYPE 18)



## 52555-40-23

LIGHTWEIGHT THERMO-PLASTIC W/ RF  
POST, NON-RATCHET  
(TYPE 23)



## 52555-40-24

LIGHTWEIGHT THERMO-PLASTIC W/ RF  
POST, W/ RATCHET (TYPE 24)





# HANDLES: NON-INSULATED



MADE IN THE USA

**52555-40-03**  
NON-INSULATED STAINLESS STEEL  
(TYPE 3)



**52555-40-21**  
STAINLESS STEEL AXIAL HANDLE V-  
SHAPED W/ SPREADING SPRING &  
THUMB RELEASE RATCHET  
(TYPE 21)



**52555-40-04**  
NON-INSULATED STAINLESS STEEL W/  
RATCHET  
(TYPE 4)



**52555-40-30**  
STAINLESS STEEL AXIAL HANDLE  
V-SHAPED W/ SPREADING SPRING, NON-  
RATCHET  
(TYPE 30)



**52555-40-11**  
NON-INSULATED RING AXIAL HANDLE  
(TYPE 11)

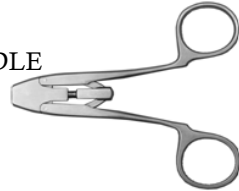

**52555-40-19**  
STAINLESS STEEL AXIAL HANDLE  
V-SHAPED, ANGLED DOWN W/  
SPREADING SPRING & RATCHET  
(TYPE 19)



**52555-40-12**  
NON-INSULATED RING AXIAL HANDLE  
W/ RATCHET  
(TYPE 12)



**52555-40-31**  
STAINLESS STEEL AXIAL  
HANDLE V-SHAPED, ANGLED DOWN W/  
SPREADING SPRING, NON-RATCHET  
(TYPE 31)



**52555-40-13**  
STAINLESS STEEL AXIAL HANDLE  
W/ PRECISE ENGAGEMENT RATCHET  
(TYPE 13)



**52555-40-26**  
ALUMINUM AXIAL HANDLE, SINGLE  
ACTION W/ RATCHET  
(TYPE 26)



**52555-40-15**  
NON-INSULATED STAINLESS STEEL LINAVEC-  
WECK STYLE W/ QUICK RELEASE RATCHET &  
LONG SHANKS  
(TYPE 15)



**52555-40-28**  
ALUMINUM AXIAL HANDLE, SINGLE  
ACTION, NON-RATCHET  
(TYPE 28)



**52555-40-16**  
NON-INSULATED STAINLESS STEEL W/  
SPRING ASSIST CLOSING  
(TYPE 16)



**52555-40-27**  
ALUMINUM AXIAL HANDLE, ANGLED  
DOWN, SINGLE ACTION W/ RATCHET  
(TYPE 27)



**52555-40-29**  
ALUMINUM AXIAL HANDLE, ANGLED  
DOWN, SINGLE ACTION, NON-RATCHET  
(TYPE 29)













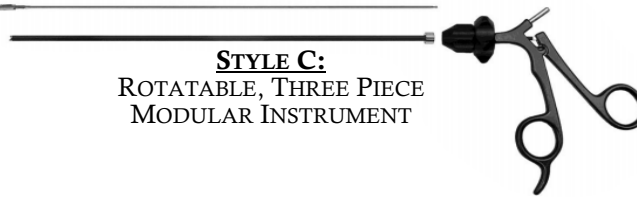



# 5MM DISSECTORS & GRASPERS

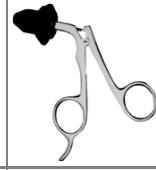

MADE IN THE USA

**STYLE C:**  
ROTATABLE, THREE PIECE  
MODULAR INSTRUMENT



| TIP ID & LENGTH  | HANDLE   |        | INSERT ONLY | TYPE 1  | TYPE 9  | TYPE 10  | TYPE 17   | TYPE 3  | TYPE 4  |
|--|----------|--------|-------------|---|---|--|---|---|---|
|  | DIAMETER | LENGTH |             |  |  |  |  |  |  |
|  |          |        |             | INSULATED HANDLES   |   |  |   | NON-INSULATED   |   |
| <b>MICRO REDDICK OLSEN</b><br>12MM TIP<br>               | 5MM      | 24CM   | 52224-01I   | 52224-01C1  | 52224-01C9  | 52224-01C10  | 52224-01C17   | 52224-01C3  | 52224-01C4  |
|  | 5MM      | 33CM   | 52255-01I   | 52255-01C1  | 52255-01C9  | 52255-01C10  | 52255-01C17   | 52255-01C3  | 52255-01C4  |
|  | 5MM      | 36CM   | 52236-01I   | 52236-01C1  | 52236-01C9  | 52236-01C10  | 52236-01C17   | 52236-01C3  | 52236-01C4  |
|  | 5MM      | 45CM   | 52155-01I   | 52155-01C1  | 52155-01C9  | 52155-01C10  | 52155-01C17   | 52155-01C3  | 52155-01C4  |
| <b>STANDARD GRASPER W/ SPOON</b><br>12MM TIP<br>         | 5MM      | 24CM   | 52224-02I   | 52224-02C1  | 52224-02C9  | 52224-02C10  | 52224-02C17   | 52224-02C3  | 52224-02C4  |
|  | 5MM      | 33CM   | 52255-02I   | 52255-02C1  | 52255-02C9  | 52255-02C10  | 52255-02C17   | 52255-02C3  | 52255-02C4  |
|  | 5MM      | 36CM   | 52236-02I   | 52236-02C1  | 52236-02C9  | 52236-02C10  | 52236-02C17   | 52236-02C3  | 52236-02C4  |
|  | 5MM      | 45CM   | 52155-02I   | 52155-02C1  | 52155-02C9  | 52155-02C10  | 52155-02C17   | 52155-02C3  | 52155-02C4  |
| <b>STANDARD GRASPER W/ SPOON, LONG</b><br>20MM TIP<br> | 5MM      | 24CM   | 52224-52I   | 52224-52C1  | 52224-52C9  | 52224-52C10  | 52224-52C17   | 52224-52C3  | 52224-52C4  |
|  | 5MM      | 33CM   | 52255-52I   | 52255-52C1  | 52255-52C9  | 52255-52C10  | 52255-52C17   | 52255-52C3  | 52255-52C4  |
|  | 5MM      | 36CM   | 52236-52I   | 52236-52C1  | 52236-52C9  | 52236-52C10  | 52236-52C17   | 52236-52C3  | 52236-52C4  |
|  | 5MM      | 45CM   | 52155-52I   | 52155-52C1  | 52155-52C9  | 52155-52C10  | 52155-52C17   | 52155-52C3  | 52155-52C4  |
| <b>STANDARD GRASPER</b><br>12MM TIP<br>                | 5MM      | 24CM   | 52224-03I   | 52224-03C1  | 52224-03C9  | 52224-03C10  | 52224-03C17   | 52224-03C3  | 52224-03C4  |
|  | 5MM      | 33CM   | 52255-03I   | 52255-03C1  | 52255-03C9  | 52255-03C10  | 52255-03C17   | 52255-03C3  | 52255-03C4  |
|  | 5MM      | 36CM   | 52236-03I   | 52236-03C1  | 52236-03C9  | 52236-03C10  | 52236-03C17   | 52236-03C3  | 52236-03C4  |
|  | 5MM      | 45CM   | 52155-03I   | 52155-03C1  | 52155-03C9  | 52155-03C10  | 52155-03C17   | 52155-03C3  | 52155-03C4  |
| <b>BULLET-NOSE GRASPER W/ SPOON</b><br>12MM TIP<br>    | 5MM      | 24CM   | 52224-04I   | 52224-04C1  | 52224-04C9  | 52224-04C10  | 52224-04C17   | 52224-04C3  | 52224-04C4  |
|  | 5MM      | 33CM   | 52255-04I   | 52255-04C1  | 52255-04C9  | 52255-04C10  | 52255-04C17   | 52255-04C3  | 52255-04C4  |
|  | 5MM      | 36CM   | 52236-04I   | 52236-04C1  | 52236-04C9  | 52236-04C10  | 52236-04C17   | 52236-04C3  | 52236-04C4  |
|  | 5MM      | 45CM   | 52155-04I   | 52155-04C1  | 52155-04C9  | 52155-04C10  | 52155-04C17   | 52155-04C3  | 52155-04C4  |
| <b>TAPERED DOLPHIN-NOSE</b><br>15MM TIP<br>            | 5MM      | 24CM   | 52224-05I   | 52224-05C1  | 52224-05C9  | 52224-05C10  | 52224-05C17   | 52224-05C3  | 52224-05C4  |
|  | 5MM      | 33CM   | 52255-05I   | 52255-05C1  | 52255-05C9  | 52255-05C10  | 52255-05C17   | 52255-05C3  | 52255-05C4  |
|  | 5MM      | 36CM   | 52236-05I   | 52236-05C1  | 52236-05C9  | 52236-05C10  | 52236-05C17   | 52236-05C3  | 52236-05C4  |
|  | 5MM      | 45CM   | 52155-05I   | 52155-05C1  | 52155-05C9  | 52155-05C10  | 52155-05C17   | 52155-05C3  | 52155-05C4  |
| <b>TAPERED DOLPHIN-NOSE W/ SPOON</b><br>15MM TIP<br>   | 5MM      | 24CM   | 52224-105I  | 52224-105C1   | 52224-105C9   | 52224-105C10   | 52224-105C17  | 52224-105C3   | 52224-105C4   |
|  | 5MM      | 33CM   | 52255-105I  | 52255-105C1   | 52255-105C9   | 52255-105C10   | 52255-105C17  | 52255-105C3   | 52255-105C4   |
|  | 5MM      | 36CM   | 52236-105I  | 52236-105C1   | 52236-105C9   | 52236-105C10   | 52236-105C17  | 52236-105C3   | 52236-105C4   |
|  | 5MM      | 45CM   | 52155-105I  | 52155-105C1   | 52155-105C9   | 52155-105C10   | 52155-105C17  | 52155-105C3   | 52155-105C4   |















# 5MM DISSECTORS & GRASPERS

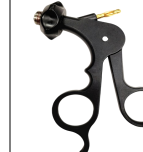
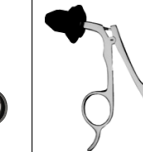
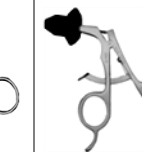

MADE IN THE USA

**STYLE C:**  
ROTATABLE, THREE PIECE  
MODULAR INSTRUMENT



| TIP ID<br>&<br>LENGTH  | HANDLE   |        | INSERT<br>ONLY | TYPE 1  | TYPE 9  | TYPE 10  | TYPE 17   | TYPE 3  | TYPE 4  |
|--|----------|--------|----------------|---|---|--|---|---|---|
|  | DIAMETER | LENGTH |                |  |  |  |  |  |  |
|  |          |        |                | INSULATED HANDLES   |   |  |   | NON-INSULATED   |   |
| TAPERED<br>DOLPHIN-NOSE<br>W/ LONG SPOON<br>22MM TIP<br> | 5MM      | 24CM   | 52224-205I     | 52224-205C1   | 52224-205C9   | 52224-205C10   | 52224-205C17  | 52224-205C3   | 52224-205C4   |
|  | 5MM      | 33CM   | 52255-205I     | 52255-205C1   | 52255-205C9   | 52255-205C10   | 52255-205C17  | 52255-205C3   | 52255-205C4   |
|  | 5MM      | 36CM   | 52236-205I     | 52236-205C1   | 52236-205C9   | 52236-205C10   | 52236-205C17  | 52236-205C3   | 52236-205C4   |
|  | 5MM      | 45CM   | 52155-205I     | 52155-205C1   | 52155-205C9   | 52155-205C10   | 52155-205C17  | 52155-205C3   | 52155-205C4   |
| MARYLAND<br>DISSECTOR<br>18MM TIP<br>                    | 5MM      | 24CM   | 52224-06I      | 52224-06C1  | 52224-06C9  | 52224-06C10  | 52224-06C17   | 52224-06C3  | 52224-06C4  |
|  | 5MM      | 33CM   | 52255-06I      | 52255-06C1  | 52255-06C9  | 52255-06C10  | 52255-06C17   | 52255-06C3  | 52255-06C4  |
|  | 5MM      | 36CM   | 52236-06I      | 52236-06C1  | 52236-06C9  | 52236-06C10  | 52236-06C17   | 52236-06C3  | 52236-06C4  |
|  | 5MM      | 45CM   | 52155-06I      | 52155-06C1  | 52155-06C9  | 52155-06C10  | 52155-06C17   | 52155-06C3  | 52155-06C4  |
| TAPERED<br>MARYLAND<br>DISSECTOR<br>18MM TIP<br>       | 5MM      | 24CM   | 52224-106I     | 52224-106C1   | 52224-106C9   | 52224-106C10   | 52224-106C17  | 52224-106C3   | 52224-106C4   |
|  | 5MM      | 33CM   | 52255-106I     | 52255-106C1   | 52255-106C9   | 52255-106C10   | 52255-106C17  | 52255-106C3   | 52255-106C4   |
|  | 5MM      | 36CM   | 52236-106I     | 52236-106C1   | 52236-106C9   | 52236-106C10   | 52236-106C17  | 52236-106C3   | 52236-106C4   |
|  | 5MM      | 45CM   | 52155-106I     | 52155-106C1   | 52155-106C9   | 52155-106C10   | 52155-106C17  | 52155-106C3   | 52155-106C4   |
| SHORT<br>MARYLAND<br>DISSECTOR<br>15MM TIP<br>         | 5MM      | 24CM   | 52224-206I     | 52224-206C1   | 52224-206C9   | 52224-206C10   | 52224-206C17  | 52224-206C3   | 52224-206C4   |
|  | 5MM      | 33CM   | 52255-206I     | 52255-206C1   | 52255-206C9   | 52255-206C10   | 52255-206C17  | 52255-206C3   | 52255-206C4   |
|  | 5MM      | 36CM   | 52236-206I     | 52236-206C1   | 52236-206C9   | 52236-206C10   | 52236-206C17  | 52236-206C3   | 52236-206C4   |
|  | 5MM      | 45CM   | 52155-206I     | 52155-206C1   | 52155-206C9   | 52155-206C10   | 52155-206C17  | 52155-206C3   | 52155-206C4   |
| RIGHT ANGLE<br>MIXTER, LONG<br>22MM TIP<br>            | 5MM      | 24CM   | 52224-07I      | 52224-07C1  | 52224-07C9  | 52224-07C10  | 52224-07C17   | 52224-07C3  | 52224-07C4  |
|  | 5MM      | 33CM   | 52255-07I      | 52255-07C1  | 52255-07C9  | 52255-07C10  | 52255-07C17   | 52255-07C3  | 52255-07C4  |
|  | 5MM      | 36CM   | 52236-07I      | 52236-07C1  | 52236-07C9  | 52236-07C10  | 52236-07C17   | 52236-07C3  | 52236-07C4  |
|  | 5MM      | 45CM   | 52155-07I      | 52155-07C1  | 52155-07C9  | 52155-07C10  | 52155-07C17   | 52155-07C3  | 52155-07C4  |
| RIGHT ANGLE<br>MIXTER, SHORT<br>12MM TIP<br>           | 5MM      | 24CM   | 52224-59I      | 52224-59C1  | 52224-59C9  | 52224-59C10  | 52224-59C17   | 52224-59C3  | 52224-59C4  |
|  | 5MM      | 33CM   | 52255-59I      | 52255-59C1  | 52255-59C9  | 52255-59C10  | 52255-59C17   | 52255-59C3  | 52255-59C4  |
|  | 5MM      | 36CM   | 52236-59I      | 52236-59C1  | 52236-59C9  | 52236-59C10  | 52236-59C17   | 52236-59C3  | 52236-59C4  |
|  | 5MM      | 45CM   | 52155-59I      | 52155-59C1  | 52155-59C9  | 52155-59C10  | 52155-59C17   | 52155-59C3  | 52155-59C4  |
| 45° ANGLED<br>MIXTER<br>20MM TIP<br>                   | 5MM      | 24CM   | 52224-08I      | 52224-08C1  | 52224-08C9  | 52224-08C10  | 52224-08C17   | 52224-08C3  | 52224-08C4  |
|  | 5MM      | 33CM   | 52255-08I      | 52255-08C1  | 52255-08C9  | 52255-08C10  | 52255-08C17   | 52255-08C3  | 52255-08C4  |
|  | 5MM      | 36CM   | 52236-08I      | 52236-08C1  | 52236-08C9  | 52236-08C10  | 52236-08C17   | 52236-08C3  | 52236-08C4  |
|  | 5MM      | 45CM   | 52155-08I      | 52155-08C1  | 52155-08C9  | 52155-08C10  | 52155-08C17   | 52155-08C3  | 52155-08C4  |











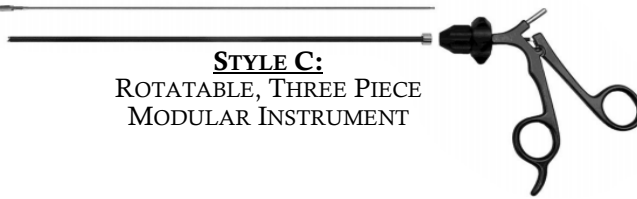





# 5MM DISSECTORS & GRASPERS

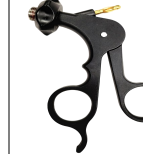
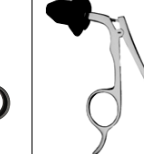
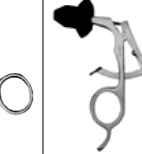

MADE IN THE USA



**STYLE C:**  
ROTATABLE, THREE PIECE  
MODULAR INSTRUMENT

| TIP ID & LENGTH   | HANDLE   |        | INSERT ONLY | TYPE 1  | TYPE 9  | TYPE 10  | TYPE 17   | TYPE 3  | TYPE 4  |
|---|----------|--------|-------------|---|---|--|---|---|---|
|   | DIAMETER | LENGTH |             |  |  |  |  |  |  |
|   |          |        |             | INSULATED HANDLES   |   |  |   | NON-INSULATED   |   |
| <b>DUCKBILL GRASPER</b><br>12MM TIP<br>                       | 5MM      | 24CM   | 52224-09I   | 52224-09C1  | 52224-09C9  | 52224-09C10  | 52224-09C17   | 52224-09C3  | 52224-09C4  |
|   | 5MM      | 33CM   | 52255-09I   | 52255-09C1  | 52255-09C9  | 52255-09C10  | 52255-09C17   | 52255-09C3  | 52255-09C4  |
|   | 5MM      | 36CM   | 52236-09I   | 52236-09C1  | 52236-09C9  | 52236-09C10  | 52236-09C17   | 52236-09C3  | 52236-09C4  |
|   | 5MM      | 45CM   | 52155-09I   | 52155-09C1  | 52155-09C9  | 52155-09C10  | 52155-09C17   | 52155-09C3  | 52155-09C4  |
| <b>NEEDLE-NOSE GRASPER</b><br>20MM TIP<br>                    | 5MM      | 24CM   | 52224-10I   | 52224-10C1  | 52224-10C9  | 52224-10C10  | 52224-10C17   | 52224-10C3  | 52224-10C4  |
|   | 5MM      | 33CM   | 52255-10I   | 52255-10C1  | 52255-10C9  | 52255-10C10  | 52255-10C17   | 52255-10C3  | 52255-10C4  |
|   | 5MM      | 36CM   | 52236-10I   | 52236-10C1  | 52236-10C9  | 52236-10C10  | 52236-10C17   | 52236-10C3  | 52236-10C4  |
|   | 5MM      | 45CM   | 52155-10I   | 52155-10C1  | 52155-10C9  | 52155-10C10  | 52155-10C17   | 52155-10C3  | 52155-10C4  |
| <b>KELLY GRASPER</b><br>14MM TIP<br>                        | 5MM      | 24CM   | 52224-11I   | 52224-11C1  | 52224-11C9  | 52224-11C10  | 52224-11C17   | 52224-11C3  | 52224-11C4  |
|   | 5MM      | 33CM   | 52255-11I   | 52255-11C1  | 52255-11C9  | 52255-11C10  | 52255-11C17   | 52255-11C3  | 52255-11C4  |
|   | 5MM      | 36CM   | 52236-11I   | 52236-11C1  | 52236-11C9  | 52236-11C10  | 52236-11C17   | 52236-11C3  | 52236-11C4  |
|   | 5MM      | 45CM   | 52155-11I   | 52155-11C1  | 52155-11C9  | 52155-11C10  | 52155-11C17   | 52155-11C3  | 52155-11C4  |
| <b>RIGHT ANGLE, LONG REACH GRASPER</b><br>22MM TIP<br>      | 5MM      | 24CM   | 52224-53I   | 52224-53C1  | 52224-53C9  | 52224-53C10  | 52224-53C17   | 52224-53C3  | 52224-53C4  |
|   | 5MM      | 33CM   | 52255-53I   | 52255-53C1  | 52255-53C9  | 52255-53C10  | 52255-53C17   | 52255-53C3  | 52255-53C4  |
|   | 5MM      | 36CM   | 52236-53I   | 52236-53C1  | 52236-53C9  | 52236-53C10  | 52236-53C17   | 52236-53C3  | 52236-53C4  |
|   | 5MM      | 45CM   | 52155-53I   | 52155-53C1  | 52155-53C9  | 52155-53C10  | 52155-53C17   | 52155-53C3  | 52155-53C4  |
| <b>PETELIN DISSECTOR, 60° ANGLE, SA</b><br>10MM TIP<br>     | 5MM      | 24CM   | 52224-12I   | 52224-12C1  | 52224-12C9  | 52224-12C10  | 52224-12C17   | 52224-12C3  | 52224-12C4  |
|   | 5MM      | 33CM   | 52255-12I   | 52255-12C1  | 52255-12C9  | 52255-12C10  | 52255-12C17   | 52255-12C3  | 52255-12C4  |
|   | 5MM      | 36CM   | 52236-12I   | 52236-12C1  | 52236-12C9  | 52236-12C10  | 52236-12C17   | 52236-12C3  | 52236-12C4  |
|   | 5MM      | 45CM   | 52155-12I   | 52155-12C1  | 52155-12C9  | 52155-12C10  | 52155-12C17   | 52155-12C3  | 52155-12C4  |
| <b>PETELIN DISSECTOR, 30° ANGLE, SA</b><br>10MM TIP<br>     | 5MM      | 24CM   | 52224-13I   | 52224-13C1  | 52224-13C9  | 52224-13C10  | 52224-13C17   | 52224-13C3  | 52224-13C4  |
|   | 5MM      | 33CM   | 52255-13I   | 52255-13C1  | 52255-13C9  | 52255-13C10  | 52255-13C17   | 52255-13C3  | 52255-13C4  |
|   | 5MM      | 36CM   | 52236-13I   | 52236-13C1  | 52236-13C9  | 52236-13C10  | 52236-13C17   | 52236-13C3  | 52236-13C4  |
|   | 5MM      | 45CM   | 52155-13I   | 52155-13C1  | 52155-13C9  | 52155-13C10  | 52155-13C17   | 52155-13C3  | 52155-13C4  |
| <b>PETELIN STRONG RIGHT ANGLE DISSECTOR</b><br>10MM TIP<br> | 5MM      | 24CM   | 52224-113I  | 52224-113C1   | 52224-113C9   | 52224-113C10   | 52224-113C17  | 52224-113C3   | 52224-113C4   |
|   | 5MM      | 33CM   | 52255-113I  | 52255-113C1   | 52255-113C9   | 52255-113C10   | 52255-113C17  | 52255-113C3   | 52255-113C4   |
|   | 5MM      | 36CM   | 52236-113I  | 52236-113C1   | 52236-113C9   | 52236-113C10   | 52236-113C17  | 52236-113C3   | 52236-113C4   |
|   | 5MM      | 45CM   | 52155-113I  | 52155-113C1   | 52155-113C9   | 52155-113C10   | 52155-113C17  | 52155-113C3   | 52155-113C4   |













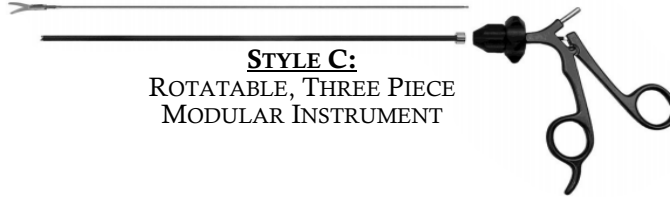



# 5MM DISSECTORS & GRASPERS

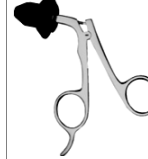

MADE IN THE USA

**STYLE C:**  
ROTATABLE, THREE PIECE  
MODULAR INSTRUMENT



| TIP ID & LENGTH  | HANDLE   |        | INSERT ONLY | TYPE 1  | TYPE 9  | TYPE 10  | TYPE 17   | TYPE 3  | TYPE 4  |
|--|----------|--------|-------------|---|---|--|---|---|---|
|  | DIAMETER | LENGTH |             |  |  |  |  |  |  |
|  |          |        |             | INSULATED HANDLES   |   |  |   | NON-INSULATED   |   |
|    | 5MM      | 24CM   | 52224-14I   | 52224-14C1  | 52224-14C9  | 52224-14C10  | 52224-14C17   | 52224-14C3  | 52224-14C4  |
|  | 5MM      | 33CM   | 52255-14I   | 52255-14C1  | 52255-14C9  | 52255-14C10  | 52255-14C17   | 52255-14C3  | 52255-14C4  |
|  | 5MM      | 36CM   | 52236-14I   | 52236-14C1  | 52236-14C9  | 52236-14C10  | 52236-14C17   | 52236-14C3  | 52236-14C4  |
|  | 5MM      | 45CM   | 52155-14I   | 52155-14C1  | 52155-14C9  | 52155-14C10  | 52155-14C17   | 52155-14C3  | 52155-14C4  |
|    | 5MM      | 24CM   | 52224-15I   | 52224-15C1  | 52224-15C9  | 52224-15C10  | 52224-15C17   | 52224-15C3  | 52224-15C4  |
|  | 5MM      | 33CM   | 52255-15I   | 52255-15C1  | 52255-15C9  | 52255-15C10  | 52255-15C17   | 52255-15C3  | 52255-15C4  |
|  | 5MM      | 36CM   | 52236-15I   | 52236-15C1  | 52236-15C9  | 52236-15C10  | 52236-15C17   | 52236-15C3  | 52236-15C4  |
|  | 5MM      | 45CM   | 52155-15I   | 52155-15C1  | 52155-15C9  | 52155-15C10  | 52155-15C17   | 52155-15C3  | 52155-15C4  |
|  | 5MM      | 24CM   | 52224-16I   | 52224-16C1  | 52224-16C9  | 52224-16C10  | 52224-16C17   | 52224-16C3  | 52224-16C4  |
|  | 5MM      | 33CM   | 52255-16I   | 52255-16C1  | 52255-16C9  | 52255-16C10  | 52255-16C17   | 52255-16C3  | 52255-16C4  |
|  | 5MM      | 36CM   | 52236-16I   | 52236-16C1  | 52236-16C9  | 52236-16C10  | 52236-16C17   | 52236-16C3  | 52236-16C4  |
|  | 5MM      | 45CM   | 52155-16I   | 52155-16C1  | 52155-16C9  | 52155-16C10  | 52155-16C17   | 52155-16C3  | 52155-16C4  |
|  | 5MM      | 24CM   | 52224-116I  | 52224-116C1   | 52224-116C9   | 52224-116C10   | 52224-116C17  | 52224-116C3   | 52224-116C4   |
|  | 5MM      | 33CM   | 52255-116I  | 52255-116C1   | 52255-116C9   | 52255-116C10   | 52255-116C17  | 52255-116C3   | 52255-116C4   |
|  | 5MM      | 36CM   | 52236-116I  | 52236-116C1   | 52236-116C9   | 52236-116C10   | 52236-116C17  | 52236-116C3   | 52236-116C4   |
|  | 5MM      | 45CM   | 52155-116I  | 52155-116C1   | 52155-116C9   | 52155-116C10   | 52155-116C17  | 52155-116C3   | 52155-116C4   |
|  | 5MM      | 24CM   | 52224-216I  | 52224-216C1   | 52224-216C9   | 52224-216C10   | 52224-216C17  | 52224-216C3   | 52224-216C4   |
|  | 5MM      | 33CM   | 52255-216I  | 52255-216C1   | 52255-216C9   | 52255-216C10   | 52255-216C17  | 52255-216C3   | 52255-216C4   |
|  | 5MM      | 36CM   | 52236-216I  | 52236-216C1   | 52236-216C9   | 52236-216C10   | 52236-216C17  | 52236-216C3   | 52236-216C4   |
|  | 5MM      | 45CM   | 52155-216I  | 52155-216C1   | 52155-216C9   | 52155-216C10   | 52155-216C17  | 52155-216C3   | 52155-216C4   |
|  | 5MM      | 24CM   | 52224-17I   | 52224-17C1  | 52224-17C9  | 52224-17C10  | 52224-17C17   | 52224-17C3  | 52224-17C4  |
|  | 5MM      | 33CM   | 52255-17I   | 52255-17C1  | 52255-17C9  | 52255-17C10  | 52255-17C17   | 52255-17C3  | 52255-17C4  |
|  | 5MM      | 36CM   | 52236-17I   | 52236-17C1  | 52236-17C9  | 52236-17C10  | 52236-17C17   | 52236-17C3  | 52236-17C4  |
|  | 5MM      | 45CM   | 52155-17I   | 52155-17C1  | 52155-17C9  | 52155-17C10  | 52155-17C17   | 52155-17C3  | 52155-17C4  |
|  | 5MM      | 24CM   | 52224-18I   | 52224-18C1  | 52224-18C9  | 52224-18C10  | 52224-18C17   | 52224-18C3  | 52224-18C4  |
|  | 5MM      | 33CM   | 52255-18I   | 52255-18C1  | 52255-18C9  | 52255-18C10  | 52255-18C17   | 52255-18C3  | 52255-18C4  |
|  | 5MM      | 36CM   | 52236-18I   | 52236-18C1  | 52236-18C9  | 52236-18C10  | 52236-18C17   | 52236-18C3  | 52236-18C4  |
|  | 5MM      | 45CM   | 52155-18I   | 52155-18C1  | 52155-18C9  | 52155-18C10  | 52155-18C17   | 52155-18C3  | 52155-18C4  |



WE DESIGN, MANUFACTURE & SELL THE TOOLS THE SURGEONS USE









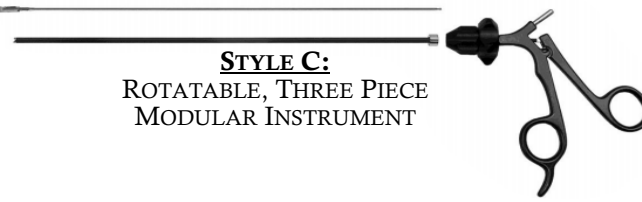





# 5MM DISSECTORS & GRASPERS

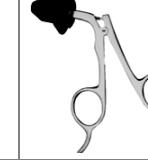
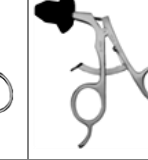

MADE IN THE USA



**STYLE C:**  
ROTATABLE, THREE PIECE  
MODULAR INSTRUMENT

| TIP ID & LENGTH   | HANDLE   |        | INSERT ONLY | TYPE 1  | TYPE 9  | TYPE 10  | TYPE 17   | TYPE 3  | TYPE 4  |
|---|----------|--------|-------------|---|---|--|---|---|---|
|   | DIAMETER | LENGTH |             |  |  |  |  |  |  |
|   |          |        |             | INSULATED HANDLES   |   |  |   | NON-INSULATED   |   |
| <b>ALLIS, SHORT VERSION, 3X4 TEETH, SERRATED 12MM TIP</b><br>         | 5MM      | 24CM   | 52224-19I   | 52224-19C1  | 52224-19C9  | 52224-19C10  | 52224-19C17   | 52224-19C3  | 52224-19C4  |
|   | 5MM      | 33CM   | 52255-19I   | 52255-19C1  | 52255-19C9  | 52255-19C10  | 52255-19C17   | 52255-19C3  | 52255-19C4  |
|   | 5MM      | 36CM   | 52236-19I   | 52236-19C1  | 52236-19C9  | 52236-19C10  | 52236-19C17   | 52236-19C3  | 52236-19C4  |
|   | 5MM      | 45CM   | 52155-19I   | 52155-19C1  | 52155-19C9  | 52155-19C10  | 52155-19C17   | 52155-19C3  | 52155-19C4  |
| <b>ALLIS, SHORT VERSION, DBL ROW OF TEETH, SERRATED 12MM TIP</b><br>  | 5MM      | 24CM   | 52224-119I  | 52224-119C1   | 52224-119C9   | 52224-119C10   | 52224-119C17  | 52224-119C3   | 52224-119C4   |
|   | 5MM      | 33CM   | 52255-119I  | 52255-119C1   | 52255-119C9   | 52255-119C10   | 52255-119C17  | 52255-119C3   | 52255-119C4   |
|   | 5MM      | 36CM   | 52236-119I  | 52236-119C1   | 52236-119C9   | 52236-119C10   | 52236-119C17  | 52236-119C3   | 52236-119C4   |
|   | 5MM      | 45CM   | 52155-119I  | 52155-119C1   | 52155-119C9   | 52155-119C10   | 52155-119C17  | 52155-119C3   | 52155-119C4   |
| <b>ALLIS, LONG VERSION, DBL ROW OF TEETH, SERRATED 25MM TIP</b><br> | 5MM      | 24CM   | 52224-219I  | 52224-219C1   | 52224-219C9   | 52224-219C10   | 52224-219C17  | 52224-219C3   | 52224-219C4   |
|   | 5MM      | 33CM   | 52255-219I  | 52255-219C1   | 52255-219C9   | 52255-219C10   | 52255-219C17  | 52255-219C3   | 52255-219C4   |
|   | 5MM      | 36CM   | 52236-219I  | 52236-219C1   | 52236-219C9   | 52236-219C10   | 52236-219C17  | 52236-219C3   | 52236-219C4   |
|   | 5MM      | 45CM   | 52155-219I  | 52155-219C1   | 52155-219C9   | 52155-219C10   | 52155-219C17  | 52155-219C3   | 52155-219C4   |
| <b>ALLIS GRASPER, MEDIUM, WECK STYLE 20MM TIP</b><br>               | 5MM      | 24CM   | 52224-20I   | 52224-20C1  | 52224-20C9  | 52224-20C10  | 52224-20C17   | 52224-20C3  | 52224-20C4  |
|   | 5MM      | 33CM   | 52255-20I   | 52255-20C1  | 52255-20C9  | 52255-20C10  | 52255-20C17   | 52255-20C3  | 52255-20C4  |
|   | 5MM      | 36CM   | 52236-20I   | 52236-20C1  | 52236-20C9  | 52236-20C10  | 52236-20C17   | 52236-20C3  | 52236-20C4  |
|   | 5MM      | 45CM   | 52155-20I   | 52155-20C1  | 52155-20C9  | 52155-20C10  | 52155-20C17   | 52155-20C3  | 52155-20C4  |
| <b>ALLIS GRASPER STD. VERSION 30MM TIP</b><br>                      | 5MM      | 24CM   | 52224-21I   | 52224-21C1  | 52224-21C9  | 52224-21C10  | 52224-21C17   | 52224-21C3  | 52224-21C4  |
|   | 5MM      | 33CM   | 52255-21I   | 52255-21C1  | 52255-21C9  | 52255-21C10  | 52255-21C17   | 52255-21C3  | 52255-21C4  |
|   | 5MM      | 36CM   | 52236-21I   | 52236-21C1  | 52236-21C9  | 52236-21C10  | 52236-21C17   | 52236-21C3  | 52236-21C4  |
|   | 5MM      | 45CM   | 52155-21I   | 52155-21C1  | 52155-21C9  | 52155-21C10  | 52155-21C17   | 52155-21C3  | 52155-21C4  |
| <b>ALLIS GRASPER, TC, STD. VERSION 35MM TIP</b><br>                 | 5MM      | 24CM   | 52224-57I   | 52224-57C1  | 52224-57C9  | 52224-57C10  | 52224-57C17   | 52224-57C3  | 52224-57C4  |
|   | 5MM      | 33CM   | 52255-57I   | 52255-57C1  | 52255-57C9  | 52255-57C10  | 52255-57C17   | 52255-57C3  | 52255-57C4  |
|   | 5MM      | 36CM   | 52236-57I   | 52236-57C1  | 52236-57C9  | 52236-57C10  | 52236-57C17   | 52236-57C3  | 52236-57C4  |
|   | 5MM      | 45CM   | 52155-57I   | 52155-57C1  | 52155-57C9  | 52155-57C10  | 52155-57C17   | 52155-57C3  | 52155-57C4  |
| <b>DEBAKEY GRASPER 20MM TIP</b><br>                                 | 5MM      | 24CM   | 52224-22I   | 52224-22C1  | 52224-22C9  | 52224-22C10  | 52224-22C17   | 52224-22C3  | 52224-22C4  |
|   | 5MM      | 33CM   | 52255-22I   | 52255-22C1  | 52255-22C9  | 52255-22C10  | 52255-22C17   | 52255-22C3  | 52255-22C4  |
|   | 5MM      | 36CM   | 52236-22I   | 52236-22C1  | 52236-22C9  | 52236-22C10  | 52236-22C17   | 52236-22C3  | 52236-22C4  |
|   | 5MM      | 45CM   | 52155-22I   | 52155-22C1  | 52155-22C9  | 52155-22C10  | 52155-22C17   | 52155-22C3  | 52155-22C4  |













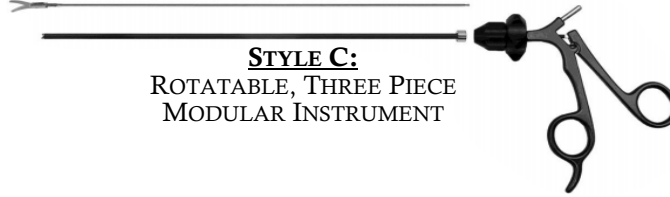





# 5MM DISSECTORS & GRASPERS



MADE IN THE USA

**STYLE C:**  
ROTATABLE, THREE PIECE  
MODULAR INSTRUMENT



| TIP ID<br>&<br>LENGTH  | HANDLE   |        | INSERT ONLY | TYPE 1  | TYPE 9  | TYPE 10  | TYPE 17   | TYPE 3  | TYPE 4  |
|--|----------|--------|-------------|---|---|--|---|---|---|
|  | DIAMETER | LENGTH |             |  |  |  |  |  |  |
|  |          |        |             | INSULATED HANDLES   |   |  |   | NON-INSULATED   |   |
| <b>DEBAKEY GRASPER</b><br>34MM TIP<br>               | 5MM      | 24CM   | 52224-222I  | 52224-222C1   | 52224-222C9   | 52224-222C10   | 52224-222C17  | 52224-222C3   | 52224-222C4   |
|  | 5MM      | 33CM   | 52255-222I  | 52255-222C1   | 52255-222C9   | 52255-222C10   | 52255-222C17  | 52255-222C3   | 52255-222C4   |
|  | 5MM      | 36CM   | 52236-222I  | 52236-222C1   | 52236-222C9   | 52236-222C10   | 52236-222C17  | 52236-222C3   | 52236-222C4   |
|  | 5MM      | 45CM   | 52155-222I  | 52155-222C1   | 52155-222C9   | 52155-222C10   | 52155-222C17  | 52155-222C3   | 52155-222C4   |
| <b>DEBAKEY GRASPER</b><br>40MM TIP<br>               | 5MM      | 24CM   | 52224-23I   | 52224-23C1  | 52224-23C9  | 52224-23C10  | 52224-23C17   | 52224-23C3  | 52224-23C4  |
|  | 5MM      | 33CM   | 52255-23I   | 52255-23C1  | 52255-23C9  | 52255-23C10  | 52255-23C17   | 52255-23C3  | 52255-23C4  |
|  | 5MM      | 36CM   | 52236-23I   | 52236-23C1  | 52236-23C9  | 52236-23C10  | 52236-23C17   | 52236-23C3  | 52236-23C4  |
|  | 5MM      | 45CM   | 52155-23I   | 52155-23C1  | 52155-23C9  | 52155-23C10  | 52155-23C17   | 52155-23C3  | 52155-23A4  |
| <b>DEBAKEY GRASPER</b><br>60MM TIP<br>             | 5MM      | 24CM   | 52224-160I  | 52224-160C1   | 52224-160C9   | 52224-160C10   | 52224-160C17  | 52224-160C3   | 52224-160C4   |
|  | 5MM      | 33CM   | 52255-160I  | 52255-160C1   | 52255-160C9   | 52255-160C10   | 52255-160C17  | 52255-160C3   | 52255-160C4   |
|  | 5MM      | 36CM   | 52236-160I  | 52236-160C1   | 52236-160C9   | 52236-160C10   | 52236-160C17  | 52236-160C3   | 52236-160C4   |
|  | 5MM      | 45CM   | 52155-160I  | 52155-160C1   | 52155-160C9   | 52155-160C10   | 52155-160C17  | 52155-160C3   | 52155-160C4   |
| <b>HUNTER DEBAKEY, FENESTRATED</b><br>16MM TIP<br> | 5MM      | 24CM   | 52224-158I  | 52224-158C1   | 52224-158C9   | 52224-158C10   | 52224-158C17  | 52224-158C3   | 52224-158C4   |
|  | 5MM      | 33CM   | 52255-158I  | 52255-158C1   | 52255-158C9   | 52255-158C10   | 52255-158C17  | 52255-158C3   | 52255-158C4   |
|  | 5MM      | 36CM   | 52236-158I  | 52236-158C1   | 52236-158C9   | 52236-158C10   | 52236-158C17  | 52236-158C3   | 52236-158C4   |
|  | 5MM      | 45CM   | 52155-158I  | 52155-158C1   | 52155-158C9   | 52155-158C10   | 52155-158C17  | 52155-158C3   | 52155-158C4   |
| <b>HUNTER DEBAKEY, FENESTRATED</b><br>20MM TIP<br> | 5MM      | 24CM   | 52224-58I   | 52224-58C1  | 52224-58C9  | 52224-58C10  | 52224-58C17   | 52224-58C3  | 52224-58C4  |
|  | 5MM      | 33CM   | 52255-58I   | 52255-58C1  | 52255-58C9  | 52255-58C10  | 52255-58C17   | 52255-58C3  | 52255-58C4  |
|  | 5MM      | 36CM   | 52236-58I   | 52236-58C1  | 52236-58C9  | 52236-58C10  | 52236-58C17   | 52236-58C3  | 52236-58C4  |
|  | 5MM      | 45CM   | 52155-58I   | 52155-58C1  | 52155-58C9  | 52155-58C10  | 52155-58C17   | 52155-58C3  | 52155-58C4  |
| <b>HUNTER DEBAKEY, FENESTRATED</b><br>40MM TIP<br> | 5MM      | 24CM   | 52224-159I  | 52224-159C1   | 52224-159C9   | 52224-159C10   | 52224-159C17  | 52224-159C3   | 52224-159C4   |
|  | 5MM      | 33CM   | 52255-159I  | 52255-159C1   | 52255-159C9   | 52255-159C10   | 52255-159C17  | 52255-159C3   | 52255-159C4   |
|  | 5MM      | 36CM   | 52236-159I  | 52236-159C1   | 52236-159C9   | 52236-159C10   | 52236-159C17  | 52236-159C3   | 52236-159C4   |
|  | 5MM      | 45CM   | 52155-159I  | 52155-159C1   | 52155-159C9   | 52155-159C10   | 52155-159C17  | 52155-159C3   | 52155-159C4   |
| <b>HUNTER DEBAKEY, FENESTRATED</b><br>60MM TIP<br> | 5MM      | 24CM   | 52224-160I  | 52224-160C1   | 52224-160C9   | 52224-160C10   | 52224-160C17  | 52224-160C3   | 52224-160C4   |
|  | 5MM      | 33CM   | 52255-160I  | 52255-160C1   | 52255-160C9   | 52255-160C10   | 52255-160C17  | 52255-160C3   | 52255-160C4   |
|  | 5MM      | 36CM   | 52236-160I  | 52236-160C1   | 52236-160C9   | 52236-160C10   | 52236-160C17  | 52236-160C3   | 52236-160C4   |
|  | 5MM      | 45CM   | 52155-160I  | 52155-160C1   | 52155-160C9   | 52155-160C10   | 52155-160C17  | 52155-160C3   | 52155-160C4   |











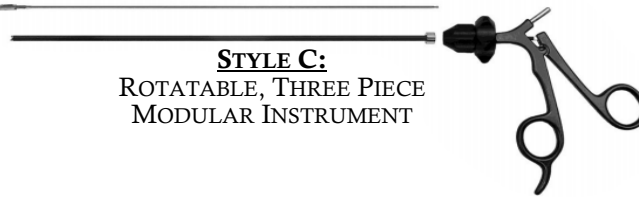



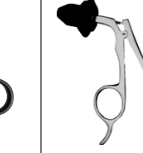
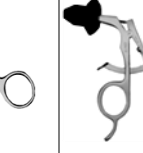

# 5MM DISSECTORS & GRASPERS



MADE IN THE USA



| TIP ID & LENGTH   | HANDLE   |        | INSERT ONLY | TYPE 1  | TYPE 9  | TYPE 10  | TYPE 17   | TYPE 3  | TYPE 4  |
|---|----------|--------|-------------|---|---|--|---|---|---|
|   | DIAMETER | LENGTH |             |  |  |  |  |  |  |
|   |          |        |             | INSULATED HANDLES   |   |  |   | NON-INSULATED   |   |
| <b>DEBAKEY GRASPER, CURVED 30MM TIP</b><br>             | 5MM      | 24CM   | 52224-46I   | 52224-46C1  | 52224-46C9  | 52224-46C10  | 52224-46C17   | 52224-46C3  | 52224-46C4  |
|   | 5MM      | 33CM   | 52255-46I   | 52255-46C1  | 52255-46C9  | 52255-46C10  | 52255-46C17   | 52255-46C3  | 52255-46C4  |
|   | 5MM      | 36CM   | 52236-46I   | 52236-46C1  | 52236-46C9  | 52236-46C10  | 52236-46C17   | 52236-46C3  | 52236-46C4  |
|   | 5MM      | 45CM   | 52155-46I   | 52155-46C1  | 52155-46C9  | 52155-46C10  | 52155-46C17   | 52155-46C3  | 52155-46C4  |
| <b>DEBAKEY MARYLAND GRASPER 35MM TIP</b><br>            | 5MM      | 24CM   | 52224-149I  | 52224-149C1   | 52224-149C9   | 52224-149C10   | 52224-149C17  | 52224-149C3   | 52224-149C4   |
|   | 5MM      | 33CM   | 52255-149I  | 52255-149C1   | 52255-149C9   | 52255-149C10   | 52255-149C17  | 52255-149C3   | 52255-149C4   |
|   | 5MM      | 36CM   | 52236-149I  | 52236-149C1   | 52236-149C9   | 52236-149C10   | 52236-149C17  | 52236-149C3   | 52236-149C4   |
|   | 5MM      | 45CM   | 52155-149I  | 52155-149C1   | 52155-149C9   | 52155-149C10   | 52155-149C17  | 52155-149C3   | 52155-149C4   |
| <b>GLASSMAN ATRAUMATIC GRASPER 30MM TIP</b><br>       | 5MM      | 24CM   | 52224-24I   | 52224-24C1  | 52224-24C9  | 52224-24C10  | 52224-24C17   | 52224-24C3  | 52224-24C4  |
|   | 5MM      | 33CM   | 52255-24I   | 52255-24C1  | 52255-24C9  | 52255-24C10  | 52255-24C17   | 52255-24C3  | 52255-24C4  |
|   | 5MM      | 36CM   | 52236-24I   | 52236-24C1  | 52236-24C9  | 52236-24C10  | 52236-24C17   | 52236-24C3  | 52236-24C4  |
|   | 5MM      | 45CM   | 52155-24I   | 52155-24C1  | 52155-24C9  | 52155-24C10  | 52155-24C17   | 52155-24C3  | 52155-24C4  |
| <b>GRASPER, CROSS SERRATED, SA 10MM TIP</b><br>       | 5MM      | 24CM   | 52224-25I   | 52224-25C1  | 52224-25C9  | 52224-25C10  | 52224-25C17   | 52224-25C3  | 52224-25C4  |
|   | 5MM      | 33CM   | 52255-25I   | 52255-25C1  | 52255-25C9  | 52255-25C10  | 52255-25C17   | 52255-25C3  | 52255-25C4  |
|   | 5MM      | 36CM   | 52236-25I   | 52236-25C1  | 52236-25C9  | 52236-25C10  | 52236-25C17   | 52236-25C3  | 52236-25C4  |
|   | 5MM      | 45CM   | 52155-25I   | 52155-25C1  | 52155-25C9  | 52155-25C10  | 52155-25C17   | 52155-25C3  | 52155-25C4  |
| <b>DOUBLE CUP FUNDUS MAXI GRASPER 16MM TIP</b><br>    | 5MM      | 24CM   | 52224-26I   | 52224-26C1  | 52224-26C9  | 52224-26C10  | 52224-26C17   | 52224-26C3  | 52224-26C4  |
|   | 5MM      | 33CM   | 52255-26I   | 52255-26C1  | 52255-26C9  | 52255-26C10  | 52255-26C17   | 52255-26C3  | 52255-26C4  |
|   | 5MM      | 36CM   | 52236-26I   | 52236-26C1  | 52236-26C9  | 52236-26C10  | 52236-26C17   | 52236-26C3  | 52236-26C4  |
|   | 5MM      | 45CM   | 52155-26I   | 52155-26C1  | 52155-26C9  | 52155-26C10  | 52155-26C17   | 52155-26C3  | 52155-26C4  |
| <b>FENESTRATED DOUBLE FUNDUS GRASPER 16MM TIP</b><br> | 5MM      | 24CM   | 52224-226I  | 52224-226C1   | 52224-226C9   | 52224-226C10   | 52224-226C17  | 52224-226C3   | 52224-226C4   |
|   | 5MM      | 33CM   | 52255-226I  | 52255-226C1   | 52255-226C9   | 52255-226C10   | 52255-226C17  | 52255-226C3   | 52255-226C4   |
|   | 5MM      | 36CM   | 52236-226C1 | 52236-226C1   | 52236-226C9   | 52236-226C10   | 52236-226C17  | 52236-226C3   | 52236-226C4   |
|   | 5MM      | 45CM   | 52155-22I   | 52155-226C1   | 52155-226C9   | 52155-226C10   | 52155-226C17  | 52155-226C3   | 52155-226C4   |
| <b>"MCKEARNAN" STYLE FUNDUS GRASPER 16MM TIP</b><br>  | 5MM      | 24CM   | 52224-126I  | 52224-126C1   | 52224-126C9   | 52224-126C10   | 52224-126C17  | 52224-126C3   | 52224-126C4   |
|   | 5MM      | 33CM   | 52255-126I  | 52255-126C1   | 52255-126C9   | 52255-126C10   | 52255-126C17  | 52255-126C3   | 52255-126C4   |
|   | 5MM      | 36CM   | 52236-126I  | 52236-126C1   | 52236-126C9   | 52236-126C10   | 52236-126C17  | 52236-126C3   | 52236-126C4   |
|   | 5MM      | 45CM   | 52155-126I  | 52155-126C1   | 52155-126C9   | 52155-126C10   | 52155-126C17  | 52155-126C3   | 52155-126C4   |











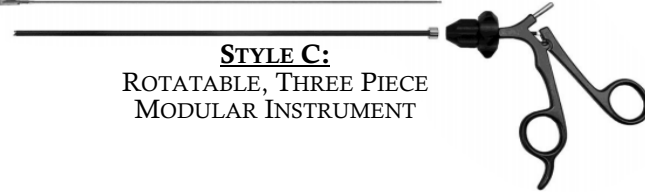





# 5MM DISSECTORS & GRASPERS

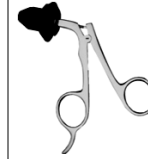
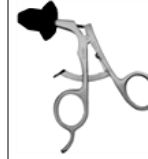

MADE IN THE USA



**STYLE C:**  
ROTATABLE, THREE PIECE  
MODULAR INSTRUMENT

| TIP ID & LENGTH  | HANDLE   |        | INSERT ONLY | TYPE 1  | TYPE 9  | TYPE 10  | TYPE 17   | TYPE 3  | TYPE 4  |
|--|----------|--------|-------------|---|---|--|---|---|---|
|  | DIAMETER | LENGTH |             |  |  |  |  |  |  |
|  |          |        |             | INSULATED HANDLES   |   |  |   | NON-INSULATED   |   |
| <b>"WINER" STYLE<br/>FUNDUS GRASPER<br/>16MM TIP</b><br>                     | 5MM      | 24CM   | 52224-326I  | 52224-326C1   | 52224-326C9   | 52224-326C10   | 52224-326C17  | 52224-326C3   | 52224-326C4   |
|  | 5MM      | 33CM   | 52255-326I  | 52255-326C1   | 52255-326C9   | 52255-326C10   | 52255-326C17  | 52255-326C3   | 52255-326C4   |
|  | 5MM      | 36CM   | 52236-326I  | 52236-326C1   | 52236-326C9   | 52236-326C10   | 52236-326C17  | 52236-326C3   | 52236-326C4   |
|  | 5MM      | 45CM   | 52155-326I  | 52155-326C1   | 52155-326C9   | 52155-326C10   | 52155-326C17  | 52155-326C3   | 52155-326C4   |
| <b>"JARIT" STYLE<br/>GRASPING FORCEPS<br/>DUAL CUP<br/>16MM TIP</b><br>      | 5MM      | 24CM   | 52224-426I  | 52224-426C1   | 52224-426C9   | 52224-426C10   | 52224-426C17  | 52224-426C3   | 52224-426C4   |
|  | 5MM      | 33CM   | 52255-426I  | 52255-426C1   | 52255-426C9   | 52255-426C10   | 52255-426C17  | 52255-426C3   | 52255-426C4   |
|  | 5MM      | 36CM   | 52236-426I  | 52236-426C1   | 52236-426C9   | 52236-426C10   | 52236-426C17  | 52236-426C3   | 52236-426C4   |
|  | 5MM      | 45CM   | 52155-426I  | 52155-426C1   | 52155-426C9   | 52155-426C10   | 52155-426C17  | 52155-426C3   | 52155-426C4   |
| <b>ENDOCLINCH<br/>FENESTRATED<br/>GRASPER<br/>20MM TIP</b><br>             | 5MM      | 24CM   | 52224-27I   | 52224-27C1  | 52224-27C9  | 52224-27C10  | 52224-27C17   | 52224-27C3  | 52224-27C4  |
|  | 5MM      | 33CM   | 52255-27CI  | 52255-27C1  | 52255-27C9  | 52255-27C10  | 52255-27C17   | 52255-27C3  | 52255-27C4  |
|  | 5MM      | 36CM   | 52236-27I   | 52236-27C1  | 52236-27C9  | 52236-27C10  | 52236-27C17   | 52236-27C3  | 52236-27C4  |
|  | 5MM      | 45CM   | 52155-27I   | 52155-27C1  | 52155-27C9  | 52155-27C10  | 52155-27C17   | 52155-27C3  | 52155-27C4  |
| <b>RETRO-FACING,<br/>RAT TOOTH W/<br/>CUP<br/>10MM TIP</b><br>             | 5MM      | 24CM   | 52224-28I   | 52224-28C1  | 52224-28C9  | 52224-28C10  | 52224-28C17   | 52224-28C3  | 52224-28C4  |
|  | 5MM      | 33CM   | 52255-28I   | 52255-28C1  | 52255-28C9  | 52255-28C10  | 52255-28C17   | 52255-28C3  | 52255-28C4  |
|  | 5MM      | 36CM   | 52236-28I   | 52236-28C1  | 52236-28C9  | 52236-28C10  | 52236-28C17   | 52236-28C3  | 52236-28C4  |
|  | 5MM      | 45CM   | 52155-28I   | 52155-28C1  | 52155-28C9  | 52155-28C10  | 52155-28C17   | 52155-28C3  | 52155-28C4  |
| <b>ALLIGATOR<br/>GRASPER, RETRO-<br/>FACING TEETH DA<br/>10MM TIP</b><br>  | 5MM      | 24CM   | 52224-29I   | 52224-29C1  | 52224-29C9  | 52224-29C10  | 52224-29C17   | 52224-29C3  | 52224-29C4  |
|  | 5MM      | 33CM   | 52255-29I   | 52255-29C1  | 52255-29C9  | 52255-29C10  | 52255-29C17   | 52255-29C3  | 52255-29C4  |
|  | 5MM      | 36CM   | 52236-29I   | 52236-29C1  | 52236-29C9  | 52236-29C10  | 52236-29C17   | 52236-29C3  | 52236-29C4  |
|  | 5MM      | 45CM   | 52155-29I   | 52155-29C1  | 52155-29C9  | 52155-29C10  | 52155-29C17   | 52155-29C3  | 52155-29C4  |
| <b>ALLIGATOR<br/>GRASPER, RETRO-<br/>FACING TEETH, DA<br/>20MM TIP</b><br> | 5MM      | 24CM   | 52224-129I  | 52224-129C1   | 52224-129C9   | 52224-129C10   | 52224-129C17  | 52224-129C3   | 52224-129C4   |
|  | 5MM      | 33CM   | 52255-129I  | 52255-129C1   | 52255-129C9   | 52255-129C10   | 52255-129C17  | 52255-129C3   | 52255-129C4   |
|  | 5MM      | 36CM   | 52236-129I  | 52236-129C1   | 52236-129C9   | 52236-129C10   | 52236-129C17  | 52236-129C3   | 52236-129C4   |
|  | 5MM      | 45CM   | 52155-129I  | 52155-129C1   | 52155-129C9   | 52155-129C10   | 52155-129C17  | 52155-129C3   | 52155-129C4   |
| <b>ALLIGATOR<br/>GRASPER, RETRO-<br/>FACING TEETH, SA<br/>10MM TIP</b><br> | 5MM      | 24CM   | 52224-30I   | 52224-30C1  | 52224-30C9  | 52224-30C10  | 52224-30C17   | 52224-30C3  | 52224-30C4  |
|  | 5MM      | 33CM   | 52255-30I   | 52255-30C1  | 52255-30C9  | 52255-30C10  | 52255-30C17   | 52255-30C3  | 52255-30C4  |
|  | 5MM      | 36CM   | 52236-30I   | 52236-30C1  | 52236-30C9  | 52236-30C10  | 52236-30C17   | 52236-30C3  | 52236-30C4  |
|  | 5MM      | 45CM   | 52155-30I   | 52155-30C1  | 52155-30C9  | 52155-30C10  | 52155-30C17   | 52155-30C3  | 52155-30C4  |











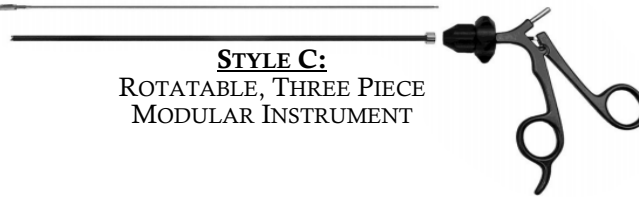





# 5MM DISSECTORS & GRASPERS

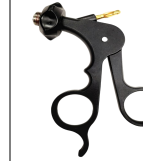
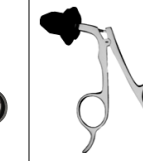
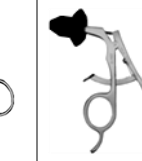

MADE IN THE USA



**STYLE C:**  
ROTATABLE, THREE PIECE  
MODULAR INSTRUMENT

| TIP ID<br>&<br>LENGTH   | HANDLE   |        | INSERT ONLY | TYPE 1  | TYPE 9  | TYPE 10  | TYPE 17   | TYPE 3  | TYPE 4  |
|---|----------|--------|-------------|---|---|--|---|---|---|
|   | DIAMETER | LENGTH |             |  |  |  |  |  |  |
|   |          |        |             | INSULATED HANDLES   |   |  |   | NON-INSULATED   |   |
| CUP SHAED GRASPER, W/<br>RETRO-FACING<br>TEETH<br>10MM TIP<br>             | 5MM      | 24CM   | 52224-31I   | 52224-31C1  | 52224-31C9  | 52224-31C10  | 52224-31C17   | 52224-31C3  | 52224-31C4  |
|   | 5MM      | 33CM   | 52255-31I   | 52255-31C1  | 52255-31C9  | 52255-31C10  | 52255-31C17   | 52255-31C3  | 52255-31C4  |
|   | 5MM      | 36CM   | 52236-31I   | 52236-31C1  | 52236-31C9  | 52236-31C10  | 52236-31C17   | 52236-31C3  | 52236-31C4  |
|   | 5MM      | 45CM   | 52155-31I   | 52155-31C1  | 52155-31C9  | 52155-31C10  | 52155-31C17   | 52155-31C3  | 52155-31C4  |
| WAVE GRASPER,<br>LONG BEVELED<br>EDGE, DA<br>22MM TIP<br>                   | 5MM      | 24CM   | 52224-32I   | 52224-32C1  | 52224-32C9  | 52224-32C10  | 52224-32C17   | 52224-32C3  | 52224-32C4  |
|   | 5MM      | 33CM   | 52255-32I   | 52255-32C1  | 52255-32C9  | 52255-32C10  | 52255-32C17   | 52255-32C3  | 52255-32C4  |
|   | 5MM      | 36CM   | 52236-32I   | 52236-32C1  | 52236-32C9  | 52236-32C10  | 52236-32C17   | 52236-32C3  | 52236-32C4  |
|   | 5MM      | 45CM   | 52155-32I   | 52155-32C1  | 52155-32C9  | 52155-32C10  | 52155-32C17   | 52155-32C3  | 52155-32C4  |
| WAVE GRASPER,<br>LONG BEVELED<br>EDGE, SA<br>22MM TIP<br>                 | 5MM      | 24CM   | 52224-33I   | 52224-33C1  | 52224-33C9  | 52224-33C10  | 52224-33C17   | 52224-33C3  | 52224-33C4  |
|   | 5MM      | 33CM   | 52255-33I   | 52255-33C1  | 52255-33C9  | 52255-33C10  | 52255-33C17   | 52255-33C3  | 52255-33C4  |
|   | 5MM      | 36CM   | 52236-33I   | 52236-33C1  | 52236-33C9  | 52236-33C10  | 52236-33C17   | 52236-33C3  | 52236-33C4  |
|   | 5MM      | 45CM   | 52155-33I   | 52155-33C1  | 52155-33C9  | 52155-33C10  | 52155-33C17   | 52155-33C3  | 52155-33C4  |
| RETRACTION<br>GRASPER, 2 X 3<br>TEETH, COBRA<br>STYLE, DA<br>20MM TIP<br> | 5MM      | 24CM   | 52224-34I   | 52224-34C1  | 52224-34C9  | 52224-34C10  | 52224-34C17   | 52224-34C3  | 52224-34C4  |
|   | 5MM      | 33CM   | 52255-34I   | 52255-34C1  | 52255-34C9  | 52255-34C10  | 52255-34C17   | 52255-34C3  | 52255-34C4  |
|   | 5MM      | 36CM   | 52236-34I   | 52236-34C1  | 52236-34C9  | 52236-34C10  | 52236-34C17   | 52236-34C3  | 52236-34C4  |
|   | 5MM      | 45CM   | 52155-34I   | 52155-34C1  | 52155-34C9  | 52155-34C10  | 52155-34C17   | 52155-34C3  | 52155-34C4  |
| RETRACTION<br>GRASPER, 2 X 3<br>TEETH, COBRA<br>STYLE, SA<br>20MM TIP<br> | 5MM      | 24CM   | 52224-35I   | 52224-35C1  | 52224-35C9  | 52224-35C10  | 52224-35C17   | 52224-35C3  | 52224-35C4  |
|   | 5MM      | 33CM   | 52255-35I   | 52255-35C1  | 52255-35C9  | 52255-35C10  | 52255-35C17   | 52255-35C3  | 52255-35C4  |
|   | 5MM      | 36CM   | 52236-35I   | 52236-35C1  | 52236-35C9  | 52236-35C10  | 52236-35C17   | 52236-35C3  | 52236-35C4  |
|   | 5MM      | 45CM   | 52155-35I   | 52155-35C1  | 52155-35C9  | 52155-35C10  | 52155-35C17   | 52155-35C3  | 52155-35C4  |
| RETRACTION<br>GRASPER, 2 X 3<br>TEETH, JARIT<br>STYLE, DA<br>20MM TIP<br> | 5MM      | 24CM   | 52224-134I  | 52224-134C1   | 52224-134C9   | 52224-134C10   | 52224-134C17  | 52224-134C3   | 52224-134C4   |
|   | 5MM      | 33CM   | 52255-134I  | 52255-134C1   | 52255-134C9   | 52255-134C10   | 52255-134C17  | 52255-134C3   | 52255-134C4   |
|   | 5MM      | 36CM   | 52236-134I  | 52236-134C1   | 52236-134C9   | 52236-134C10   | 52236-134C17  | 52236-134C3   | 52236-134C4   |
|   | 5MM      | 45CM   | 52155-134II | 52155-134C1   | 52155-134C9   | 52155-134C10   | 52155-134C17  | 52155-134C3   | 52155-134C4   |
| RETRACTION<br>GRASPER, 2 X 3<br>TEETH, JARIT<br>STYLE, SA<br>20MM TIP<br> | 5MM      | 24CM   | 52224-135I  | 52224-135C1   | 52224-135C9   | 52224-135C10   | 52224-135C17  | 52224-135C3   | 52224-135C4   |
|   | 5MM      | 33CM   | 52255-135I  | 52255-135C1   | 52255-135C9   | 52255-135C10   | 52255-135C17  | 52255-135C3   | 52255-135C4   |
|   | 5MM      | 36CM   | 52236-135I  | 52236-135C1   | 52236-135C9   | 52236-135C10   | 52236-135C17  | 52236-135C3   | 52236-135C4   |
|   | 5MM      | 45CM   | 52155-135I  | 52155-135C1   | 52155-135C9   | 52155-135C10   | 52155-135C17  | 52155-135C3   | 52155-135C4   |











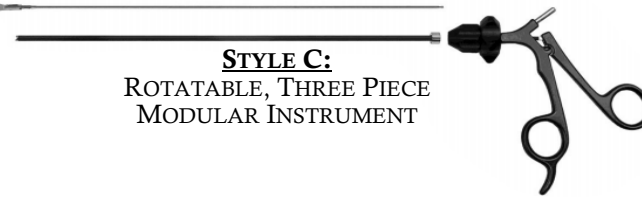





# 5MM DISSECTORS & GRASPERS

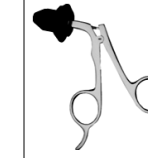
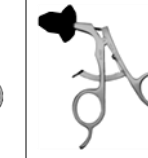

MADE IN THE USA



**STYLE C:**  
ROTATABLE, THREE PIECE  
MODULAR INSTRUMENT

| TIP ID & LENGTH   | HANDLE |        | INSERT ONLY | TYPE 1  | TYPE 9  | TYPE 10  | TYPE 17   | TYPE 3  | TYPE 4  |
|---|--------|--------|-------------|---|---|--|---|---|---|
|   | DIA.   | LENGTH |             |  |  |  |  |  |  |
|   |        |        |             | INSULATED HANDLES   |   |  |   | NON-INSULATED   |   |
|  CLAW GRASPER,<br>2 X 3 TEETH, SA<br>20MM TIP                         | 5MM    | 24CM   | 52224-36I   | 52224-36C1  | 52224-36C9  | 52224-36C10  | 52224-36C17   | 52224-36C3  | 52224-36C4  |
|   | 5MM    | 33CM   | 52255-36I   | 52255-36C1  | 52255-36C9  | 52255-36C10  | 52255-36C17   | 52255-36C3  | 52255-36C4  |
|   | 5MM    | 36CM   | 52236-36I   | 52236-36C1  | 52236-36C9  | 52236-36C10  | 52236-36C17   | 52236-36C3  | 52236-36C4  |
|   | 5MM    | 45CM   | 52155-36I   | 52155-36C1  | 52155-36C9  | 52155-36C10  | 52155-36C17   | 52155-36C3  | 52155-36C4  |
|  CLAW GRASPER,<br>2 X 3 TEETH, W/<br>XTRA ROW OF<br>TEETH<br>20MM TIP | 5MM    | 24CM   | 52224-136I  | 52224-136C1   | 52224-136C9   | 52224-136C10   | 52224-136C17  | 52224-136C3   | 52224-136C4   |
|   | 5MM    | 33CM   | 52255-136I  | 52255-136C1   | 52255-136C9   | 52255-136C10   | 52255-136C17  | 52255-136C3   | 52255-136C4   |
|   | 5MM    | 36CM   | 52236-136I  | 52236-136C1   | 52236-136C9   | 52236-136C10   | 52236-136C17  | 52236-136C3   | 52236-136C4   |
|   | 5MM    | 45CM   | 52155-136I  | 52155-136C1   | 52155-136C9   | 52155-136C10   | 52155-136C17  | 52155-136C3   | 52155-136C4   |
|  ATRAUMATIC<br>FENESTRATED<br>GRASPER,<br>CURVED<br>16MM TIP        | 5MM    | 24CM   | 52224-37I   | 52224-37C1  | 52224-37C9  | 52224-37C10  | 52224-37C17   | 52224-37C3  | 52224-37C4  |
|   | 5MM    | 33CM   | 52255-37I   | 52255-37C1  | 52255-37C9  | 52255-37C10  | 52255-37C17   | 52255-37C3  | 52255-37C4  |
|   | 5MM    | 36CM   | 52236-37I   | 52236-37C1  | 52236-37C9  | 52236-37C10  | 52236-37C17   | 52236-37C3  | 52236-37C4  |
|   | 5MM    | 45CM   | 52155-37I   | 52155-37C1  | 52155-37C9  | 52155-37C10  | 52155-37C17   | 52155-37C3  | 52155-37C4  |
|  FENESTRATED<br>GRASPER<br>16MM TIP                                 | 5MM    | 24CM   | 52224-38I   | 52224-38C1  | 52224-38C9  | 52224-38C10  | 52224-38C17   | 52224-38C3  | 52224-38C4  |
|   | 5MM    | 33CM   | 52255-38I   | 52255-38C1  | 52255-38C9  | 52255-38C10  | 52255-38C17   | 52255-38C3  | 52255-38C4  |
|   | 5MM    | 36CM   | 52236-38I   | 52236-38C1  | 52236-38C9  | 52236-38C10  | 52236-38C17   | 52236-38C3  | 52236-38C4  |
|   | 5MM    | 45CM   | 52155-38I   | 52155-38C1  | 52155-38C9  | 52155-38C10  | 52155-38C17   | 52155-38C3  | 52155-38C4  |
|  FENESTRATED<br>GRASPER<br>20MM TIP                                 | 5MM    | 24CM   | 52224-39I   | 52224-39C1  | 52224-39C9  | 52224-39C10  | 52224-39C17   | 52224-39C3  | 52224-39C4  |
|   | 5MM    | 33CM   | 52255-39I   | 52255-39C1  | 52255-39C9  | 52255-39C10  | 52255-39C17   | 52255-39C3  | 52255-39C4  |
|   | 5MM    | 36CM   | 52236-39I   | 52236-39C1  | 52236-39C9  | 52236-39C10  | 52236-39C17   | 52236-39C3  | 52236-39C4  |
|   | 5MM    | 45CM   | 52155-39I   | 52155-39C1  | 52155-39C9  | 52155-39C10  | 52155-39C17   | 52155-39C3  | 52155-39C4  |
|  FENESTRATED<br>GRASPER<br>40MM TIP                                 | 5MM    | 24CM   | 52224-40I   | 52224-40C1  | 52224-40C9  | 52224-40C10  | 52224-40C17   | 52224-40C3  | 52224-40C4  |
|   | 5MM    | 33CM   | 52255-40I   | 52255-40C1  | 52255-40C9  | 52255-40C10  | 52255-40C17   | 52255-40C3  | 52255-40C4  |
|   | 5MM    | 36CM   | 52236-40I   | 52236-40C1  | 52236-40C9  | 52236-40C10  | 52236-40C17   | 52236-40C3  | 52236-40C4  |
|   | 5MM    | 45CM   | 52155-40I   | 52155-40C1  | 52155-40C9  | 52155-40C10  | 52155-40C17   | 52155-40C3  | 52155-40C4  |
|  JOHAN<br>FENESTRATED<br>GRASPER, SA<br>20MM TIP                    | 5MM    | 24CM   | 52224-41I   | 52224-41C1  | 52224-41C9  | 52224-41C10  | 52224-41C17   | 52224-41C3  | 52224-41C4  |
|   | 5MM    | 33CM   | 52255-41I   | 52255-41C1  | 52255-41C9  | 52255-41C10  | 52255-41C17   | 52255-41C3  | 52255-41C4  |
|   | 5MM    | 36CM   | 52236-41I   | 52236-41C1  | 52236-41C9  | 52236-41C10  | 52236-41C17   | 52236-41C3  | 52236-41C4  |
|   | 5MM    | 45CM   | 52155-41I   | 52155-41C1  | 52155-41C9  | 52155-41C10  | 52155-41C17   | 52155-41C3  | 52155-41C4  |











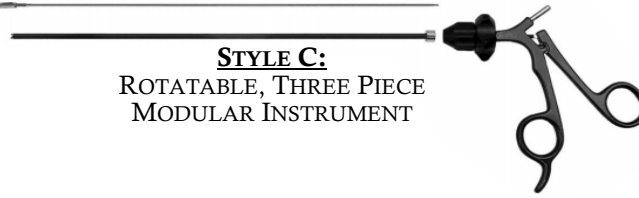





# 5MM DISSECTORS & GRASPERS



MADE IN THE USA

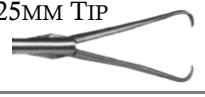

| TIP ID & LENGTH  | HANDLE   |        | INSERT ONLY | TYPE 1  | TYPE 9  | TYPE 10  | TYPE 17   | TYPE 3  | TYPE 4  |
|--|----------|--------|-------------|---|---|--|---|---|---|
|  | DIAMETER | LENGTH |             |  |  |  |  |  |  |
|  |          |        |             | INSULATED HANDLES   |   |  |   | NON-INSULATED   |   |
| <b>JOHAN FENESTRATED GRASPER, 45MM TIP, SA 45MM TIP</b><br>            | 5MM      | 24CM   | 52224-42I   | 52224-42C1  | 52224-42C9  | 52224-42C10  | 52224-42C17   | 52224-42C3  | 52224-42C4  |
|  | 5MM      | 33CM   | 52255-42I   | 52255-42C1  | 52255-42C9  | 52255-42C10  | 52255-42C17   | 52255-42C3  | 52255-42C4  |
|  | 5MM      | 36CM   | 52236-42I   | 52236-42C1  | 52236-42C9  | 52236-42C10  | 52236-42C17   | 52236-42C3  | 52236-42C4  |
|  | 5MM      | 45CM   | 52155-42I   | 52155-42C1  | 52155-42C9  | 52155-42C10  | 52155-42C17   | 52155-42C3  | 52155-42C4  |
| <b>DOUBLE FENESTRATED GRASPER 25MM TIP</b><br>                         | 5MM      | 24CM   | 52224-139I  | 52224-139C1   | 52224-139C9   | 52224-139C10   | 52224-139C17  | 52224-139C3   | 52224-139C4   |
|  | 5MM      | 33CM   | 52255-139I  | 52255-139C1   | 52255-139C9   | 52255-139C10   | 52255-139C17  | 52255-139C3   | 52255-139C4   |
|  | 5MM      | 36CM   | 52236-139I  | 52236-139C1   | 52236-139C9   | 52236-139C10   | 52236-139C17  | 52236-139C3   | 52236-139C4   |
|  | 5MM      | 45CM   | 52155-139I  | 52155-139C1   | 52155-139C9   | 52155-139C10   | 52155-139C17  | 52155-139C3   | 52155-139C4   |
| <b>KOCHER GRASPER, 1 X 2 TEETH, SA 15MM TIP</b><br>                  | 5MM      | 24CM   | 52224-43I   | 52224-43C1  | 52224-43C9  | 52224-43C10  | 52224-43C17   | 52224-43C3  | 52224-43C4  |
|  | 5MM      | 33CM   | 52255-43I   | 52255-43C1  | 52255-43C9  | 52255-43C10  | 52255-43C17   | 52255-43C3  | 52255-43C4  |
|  | 5MM      | 36CM   | 52236-43I   | 52236-43C1  | 52236-43C9  | 52236-43C10  | 52236-43C17   | 52236-43C3  | 52236-43C4  |
|  | 5MM      | 45CM   | 52155-43I   | 52155-43C1  | 52155-43C9  | 52155-43C10  | 52155-43C17   | 52155-43C3  | 52155-43C4  |
| <b>KOCHER GRASPER, 1 X 2 TEETH, DA (WECK TYPE) 15MM TIP</b><br>      | 5MM      | 24CM   | 52224-44I   | 52224-44C1  | 52224-44C9  | 52224-44C10  | 52224-44C17   | 52224-44C3  | 52224-44C4  |
|  | 5MM      | 33CM   | 52255-44I   | 52255-44C1  | 52255-44C9  | 52255-44C10  | 52255-44C17   | 52255-44C3  | 52255-44C4  |
|  | 5MM      | 36CM   | 52236-44I   | 52236-44C1  | 52236-44C9  | 52236-44C10  | 52236-44C17   | 52236-44C3  | 52236-44C4  |
|  | 5MM      | 45CM   | 52155-44I   | 52155-44C1  | 52155-44C9  | 52155-44C10  | 52155-44C17   | 52155-44C3  | 52155-44C4  |
| <b>SCHROEDER TENACULUM, SINGLE TOOTH, ROUND TIP 25MM TIP</b><br>     | 5MM      | 24CM   | 52224-45I   | 52224-45C1  | 52224-45C9  | 52224-45C10  | 52224-45C17   | 52224-45C3  | 52224-45C4  |
|  | 5MM      | 33CM   | 52255-45I   | 52255-45C1  | 52255-45C9  | 52255-45C10  | 52255-45C17   | 52255-45C3  | 52255-45C4  |
|  | 5MM      | 36CM   | 52236-45I   | 52236-45C1  | 52236-45C9  | 52236-45C10  | 52236-45C17   | 52236-45C3  | 52236-45C4  |
|  | 5MM      | 45CM   | 52155-45I   | 52155-45C1  | 52155-45C9  | 52155-45C10  | 52155-45C17   | 52155-45C3  | 52155-45C4  |
| <b>SCHROEDER TENACULUM, SINGLE TOOTH SQUARE TIP 25MM TIP</b><br>     | 5MM      | 24CM   | 52224-245I  | 52224-245C1   | 52224-245C9   | 52224-245C10   | 52224-245C17  | 52224-245C3   | 52224-245C4   |
|  | 5MM      | 33CM   | 52255-245I  | 52255-245C1   | 52255-245C9   | 52255-245C10   | 52255-245C17  | 52255-245C3   | 52255-245C4   |
|  | 5MM      | 36CM   | 52236-245I  | 52236-245C1   | 52236-245C9   | 52236-245C10   | 52236-245C17  | 52236-245C3   | 52236-245C4   |
|  | 5MM      | 45CM   | 52155-245I  | 52155-245C1   | 52155-245C9   | 52155-245C10   | 52155-245C17  | 52155-245C3   | 52155-245C4   |
| <b>SCHROEDER TEN. GRASPER, SINGLE TOOTH, XTRA TOOTH 25MM TIP</b><br> | 5MM      | 24CM   | 52224-94I   | 52224-94C1  | 52224-94C9  | 52224-94C10  | 52224-94C17   | 52224-94C3  | 52224-94C4  |
|  | 5MM      | 33CM   | 52255-94I   | 52255-94C1  | 52255-94C9  | 52255-94C10  | 52255-94C17   | 52255-94C3  | 52255-94C4  |
|  | 5MM      | 36CM   | 52236-94I   | 52236-94C1  | 52236-94C9  | 52236-94C10  | 52236-94C17   | 52236-94C3  | 52236-94C4  |
|  | 5MM      | 45CM   | 52155-94I   | 52155-94C1  | 52155-94C9  | 52155-94C10  | 52155-94C17   | 52155-94C3  | 52155-94C4  |













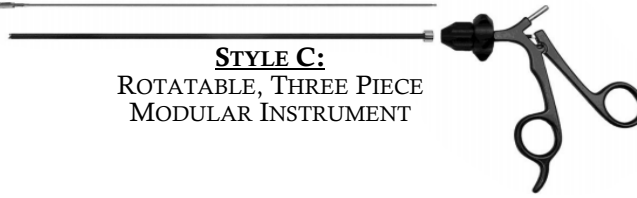



# 5MM DISSECTORS & GRASPERS

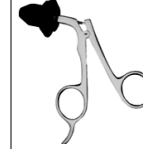
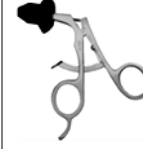

MADE IN THE USA

**STYLE C:**  
ROTATABLE, THREE PIECE  
MODULAR INSTRUMENT



| TIP ID & LENGTH  | HANDLE   |        | INSERT ONLY | TYPE 1  | TYPE 9  | TYPE 10  | TYPE 17   | TYPE 3  | TYPE 4  |
|--|----------|--------|-------------|---|---|--|---|---|---|
|  | DIAMETER | LENGTH |             |  |  |  |  |  |  |
|  |          |        |             | INSULATED HANDLES   |   |  |   | NON-INSULATED   |   |
| <b>BLUNT ATRAUMATIC GRASPING FORCEPS, DA, 14MM TIP</b><br>               | 5MM      | 24CM   | 52224-47I   | 52224-47C1  | 52224-47C9  | 52224-47C10  | 52224-47C17   | 52224-47C3  | 52224-47C4  |
|  | 5MM      | 33CM   | 52255-47I   | 52255-47C1  | 52255-47C9  | 52255-47C10  | 52255-47C17   | 52255-47C3  | 52255-47C4  |
|  | 5MM      | 36CM   | 52236-47I   | 52236-47C1  | 52236-47C9  | 52236-47C10  | 52236-47C17   | 52236-47C3  | 52236-47C4  |
|  | 5MM      | 45CM   | 52155-47I   | 52155-47C1  | 52155-47C9  | 52155-47C10  | 52155-47C17   | 52155-47C3  | 52155-47C4  |
| <b>BLUNT ATRAUMATIC GRASPER W/ CROSS-SERRATED TIPS, DA, 14MM TIP</b><br> | 5MM      | 24CM   | 52224-56I   | 52224-56C1  | 52224-56C9  | 52224-56C10  | 52224-56C17   | 52224-56C3  | 52224-56C4  |
|  | 5MM      | 33CM   | 52255-56I   | 52255-56C1  | 52255-56C9  | 52255-56C10  | 52255-56C17   | 52255-56C3  | 52255-56C4  |
|  | 5MM      | 36CM   | 52236-56I   | 52236-56C1  | 52236-56C9  | 52236-56C10  | 52236-56C17   | 52236-56C3  | 52236-56C4  |
|  | 5MM      | 45CM   | 52155-56I   | 52155-56C1  | 52155-56C9  | 52155-56C10  | 52155-56C17   | 52155-56C3  | 52155-56C4  |
| <b>BULLET NOSE GRASPER TC, MICRO DIAMOND JAW, 15MM TIP</b><br>         | 5MM      | 24CM   | 52224-48I   | 52224-48C1  | 52224-48C9  | 52224-48C10  | 52224-48C17   | 52224-48C3  | 52224-48C4  |
|  | 5MM      | 33CM   | 52255-48I   | 52255-48C1  | 52255-48C9  | 52255-48C10  | 52255-48C17   | 52255-48C3  | 52255-48C4  |
|  | 5MM      | 36CM   | 52236-48I   | 52236-48C1  | 52236-48C9  | 52236-48C10  | 52236-48C17   | 52236-48C3  | 52236-48C4  |
|  | 5MM      | 45CM   | 52155-48I   | 52155-48C1  | 52155-48C9  | 52155-48C10  | 52155-48C17   | 52155-48C3  | 52155-48C4  |
| <b>BULLET NOSE GRASPER, TC, CROSS DIAMOND JAW, 15MM TIP</b><br>        | 5MM      | 24CM   | 52224-49I   | 52224-49C1  | 52224-49C9  | 52224-49C10  | 52224-49C17   | 52224-49C3  | 52224-49C4  |
|  | 5MM      | 33CM   | 52255-49I   | 52255-49C1  | 52255-49C9  | 52255-49C10  | 52255-49C17   | 52255-49C3  | 52255-49C4  |
|  | 5MM      | 36CM   | 52236-49I   | 52236-49C1  | 52236-49C9  | 52236-49C10  | 52236-49C17   | 52236-49C3  | 52236-49C4  |
|  | 5MM      | 45CM   | 52155-49I   | 52155-49C1  | 52155-49C9  | 52155-49C10  | 52155-49C17   | 52155-49C3  | 52155-49C4  |
| <b>LONG TAPERED GRASPER W/ ATRAUMATIC TEETH 20MM TIP</b><br>           | 5MM      | 24CM   | 52224-51I   | 52224-51C1  | 52224-51C9  | 52224-51C10  | 52224-51C17   | 52224-51C3  | 52224-51C4  |
|  | 5MM      | 33CM   | 52255-51I   | 52255-51C1  | 52255-51C9  | 52255-51C10  | 52255-51C17   | 52255-51C3  | 52255-51C4  |
|  | 5MM      | 36CM   | 52236-51I   | 52236-51C1  | 52236-51C9  | 52236-51C10  | 52236-51C17   | 52236-51C3  | 52236-51C4  |
|  | 5MM      | 45CM   | 52155-51I   | 52155-51C1  | 52155-51C9  | 52155-51C10  | 52155-51C17   | 52155-51C3  | 52155-51C4  |
| <b>WAVE GRASPER, POINTED, SA 14MM TIP</b><br>                          | 5MM      | 24CM   | 52224-54I   | 52224-54C1  | 52224-54C9  | 52224-54C10  | 52224-54C17   | 52224-54C3  | 52224-54C4  |
|  | 5MM      | 33CM   | 52255-54I   | 52255-54C1  | 52255-54C9  | 52255-54C10  | 52255-54C17   | 52255-54C3  | 52255-54C4  |
|  | 5MM      | 36CM   | 52236-54I   | 52236-54C1  | 52236-54C9  | 52236-54C10  | 52236-54C17   | 52236-54C3  | 52236-54C4  |
|  | 5MM      | 45CM   | 52155-54I   | 52155-54C1  | 52155-54C9  | 52155-54C10  | 52155-54C17   | 52155-54C3  | 52155-54C4  |
| <b>"ACCESS" TYPE FENESTRATED GRASPER 20MM TIP</b><br>                  | 5MM      | 24CM   | 52224-19II  | 52224-19IC1   | 52224-19IC9   | 52224-19IC10   | 52224-19IC17  | 52224-19IC3   | 52224-19IC4   |
|  | 5MM      | 33CM   | 52255-19II  | 52255-19IC1   | 52255-19IC9   | 52255-19IC10   | 52255-19IC17  | 52255-19IC3   | 52255-19IC4   |
|  | 5MM      | 36CM   | 52236-19II  | 52236-19IC1   | 52236-19IC9   | 52236-19IC10   | 52236-19IC17  | 52236-19IC3   | 52236-19IC4   |
|  | 5MM      | 45CM   | 52155-19II  | 52155-19IC1   | 52155-19IC9   | 52155-19IC10   | 52155-19IC17  | 52155-19IC3   | 52155-19IC4   |











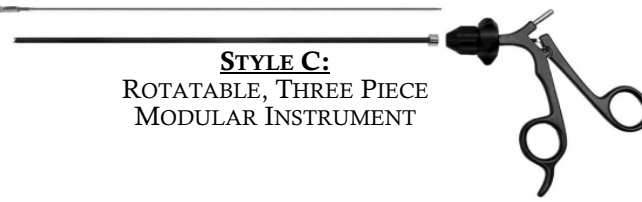







# 5MM DISSECTORS & GRASPERS



MADE IN THE USA



**STYLE C:**  
ROTATABLE, THREE PIECE  
MODULAR INSTRUMENT

| TIP ID & LENGTH   | HANDLE   |        | INSERT ONLY | TYPE 1  | TYPE 9  | TYPE 10  | TYPE 17   | TYPE 3  | TYPE 4  |
|---|----------|--------|-------------|---|---|--|---|---|---|
|   | DIAMETER | LENGTH |             |  |  |  |  |  |  |
|   |          |        |             | INSULATED HANDLES   |   |  |   | NON-INSULATED   |   |
| <b>DEBAKEY GRASPER, SA 22MM TIP</b><br>                                 | 5MM      | 24CM   | 52224-122I  | 52224-122C1   | 52224-122C9   | 52224-122C10   | 52224-122C17  | 52224-122C3   | 52224-122C4   |
|   | 5MM      | 33CM   | 52255-122I  | 52255-122C1   | 52255-122C9   | 52255-122C10   | 52255-122C17  | 52255-122C3   | 52255-122C4   |
|   | 5MM      | 36CM   | 52236-122I  | 52236-122C1   | 52236-122C9   | 52236-122C10   | 52236-122C17  | 52236-122C3   | 52236-122C4   |
|   | 5MM      | 45CM   | 52155-122I  | 52155-122C1   | 52155-122C9   | 52155-122C10   | 52155-122C17  | 52155-122C3   | 52155-122C4   |
| <b>STANDARD GRASPER, LONG 20MM TIP</b><br>                              | 5MM      | 24CM   | 52224-103I  | 52224-103C1   | 52224-103C9   | 52224-103C10   | 52224-103C17  | 52224-103C3   | 52224-103C4   |
|   | 5MM      | 33CM   | 52255-103I  | 52255-103C1   | 52255-103C9   | 52255-103C10   | 52255-103C17  | 52255-103C3   | 52255-103C4   |
|   | 5MM      | 36CM   | 52236-103I  | 52236-103C1   | 52236-103C9   | 52236-103C10   | 52236-103C17  | 52236-103C3   | 52236-103C4   |
|   | 5MM      | 45CM   | 52155-103I  | 52155-103C1   | 52155-103C9   | 52155-103C10   | 52155-103C17  | 52155-103C3   | 52155-103C4   |
| <b>TUBAL GRASPER, DA 10MM TIP</b><br>                                 | 5MM      | 24CM   | 52224-156I  | 52224-156C1   | 52224-156C9   | 52224-156C10   | 52224-156C17  | 52224-156C3   | 52224-156C4   |
|   | 5MM      | 33CM   | 52255-156I  | 52255-156C1   | 52255-156C9   | 52255-156C10   | 52255-156C17  | 52255-156C3   | 52255-156C4   |
|   | 5MM      | 36CM   | 52236-156I  | 52236-156C1   | 52236-156C9   | 52236-156C10   | 52236-156C17  | 52236-156C3   | 52236-156C4   |
|   | 5MM      | 45CM   | 52155-156I  | 52155-156C1   | 52155-156C9   | 52155-156C10   | 52155-156C17  | 52155-156C3   | 52155-156C4   |
| <b>“DAVOL” TYPE, SCOOPED JAW &amp; GENTLY MASH TEETH 15MM TIP</b><br> | 5MM      | 24CM   | 52224-90I   | 52224-90C1  | 52224-90C9  | 52224-90C10  | 52224-90C17   | 52224-90C3  | 52224-90C4  |
|   | 5MM      | 33CM   | 52255-90I   | 52255-90C1  | 52255-90C9  | 52255-90C10  | 52255-90C17   | 52255-90C3  | 52255-90C4  |
|   | 5MM      | 36CM   | 52236-90I   | 52236-90C1  | 52236-90C9  | 52236-90C10  | 52236-90C17   | 52236-90C3  | 52236-90C4  |
|   | 5MM      | 45CM   | 52155-90I   | 52155-90C1  | 52155-90C9  | 52155-90C10  | 52155-90C17   | 52155-90C3  | 52155-90C4  |
| <b>“DAVOL” TYPE, SCOOPED- JAW &amp; 2X3 FRONT TEETH 15MM TIP</b><br>  | 5MM      | 24CM   | 52224-190I  | 52224-190C1   | 52224-190C9   | 52224-190C10   | 52224-190C17  | 52224-190C3   | 52224-190C4   |
|   | 5MM      | 33CM   | 52255-190I  | 52255-190C1   | 52255-190C9   | 52255-190C10   | 52255-190C17  | 52255-190C3   | 52255-190C4   |
|   | 5MM      | 36CM   | 52236-190II | 52236-190C1   | 52236-190C9   | 52236-190C10   | 52236-190C17  | 52236-190C3   | 52236-190C4   |
|   | 5MM      | 45CM   | 52155-190I  | 52155-190C1   | 52155-190C9   | 52155-190C10   | 52155-190C17  | 52155-190C3   | 52155-190C4   |
| <b>NEEDLE NOSE GRASPER, SHORT, SERRATED 11MM TIP</b><br>              | 5MM      | 24CM   | 52224-110I  | 52224-110C1   | 52224-110C9   | 52224-110C10   | 52224-110C17  | 52224-110C3   | 52224-110C4   |
|   | 5MM      | 33CM   | 52255-110I  | 52255-110C1   | 52255-110C9   | 52255-110C10   | 52255-110C17  | 52255-110C3   | 52255-110C4   |
|   | 5MM      | 36CM   | 52236-110I  | 52236-110C1   | 52236-110C9   | 52236-110C10   | 52236-110C17  | 52236-110C3   | 52236-110C4   |
|   | 5MM      | 45CM   | 52155-110I  | 52155-110C1   | 52155-110C9   | 52155-110C10   | 52155-110C17  | 52155-110C3   | 52155-110C4   |
| <b>DUAL FENESTRATED GRASPER, SA, CURVED UP TIP 20MM TIP</b><br>       | 5MM      | 24CM   | 52224-141I  | 52224-141C1   | 52224-141C9   | 52224-141C10   | 52224-141C17  | 52224-141C3   | 52224-141C4   |
|   | 5MM      | 33CM   | 52255-141I  | 52255-141C1   | 52255-141C9   | 52255-141C10   | 52255-141C17  | 52255-141C3   | 52255-141C4   |
|   | 5MM      | 36CM   | 52236-141I  | 52236-141C1   | 52236-141C9   | 52236-141C10   | 52236-141C17  | 52236-141C3   | 52236-141C4   |
|   | 5MM      | 45CM   | 52155-141I  | 52155-141C1   | 52155-141C9   | 52155-141C10   | 52155-141C17  | 52155-141C3   | 52155-141C4   |











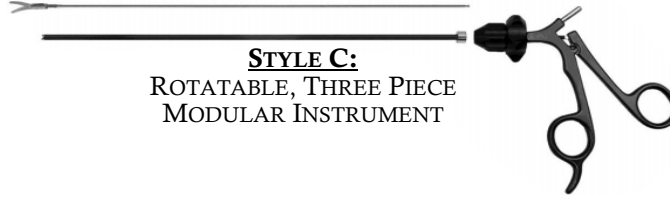

# 5MM DISSECTORS & GRASPERS



MADE IN THE USA

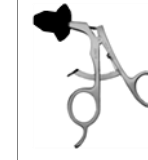

| TIP ID & LENGTH  | HANDLE   |        | INSERT ONLY | TYPE 1  | TYPE 9  | TYPE 10  | TYPE 17   | TYPE 3  | TYPE 4  |
|--|----------|--------|-------------|---|---|--|---|---|---|
|  | DIAMETER | LENGTH |             |  |  |  |  |  |  |
|  |          |        |             | INSULATED HANDLES   |   |  |   | NON-INSULATED   |   |
| FENESTRATED GRASPER, AGGRESSIVE 40MM TIP<br>       | 5MM      | 24CM   | 52224-139I  | 52224-139C1   | 52224-139C9   | 52224-139C10   | 52224-139C17  | 52224-139C3   | 52224-139C4   |
|  | 5MM      | 33CM   | 52255-139I  | 52255-139C1   | 52255-139C9   | 52255-139C10   | 52255-139C17  | 52255-139C3   | 52255-139C4   |
|  | 5MM      | 36CM   | 52236-139I  | 52236-139C1   | 52236-139C9   | 52236-139C10   | 52236-139C17  | 52236-139C3   | 52236-139C4   |
|  | 5MM      | 45CM   | 52155-139I  | 52155-139C1   | 52155-139C9   | 52155-139C10   | 52155-139C17  | 52155-139C3   | 52155-139C4   |
| GRASPING FORCEPS, ELONGATED OVAL CUP 12MM TIP<br> | 5MM      | 24CM   | 52224-102I  | 52224-102C1   | 52224-102C9   | 52224-102C10   | 52224-102C17  | 52224-102C3   | 52224-102C4   |
|  | 5MM      | 33CM   | 52255-102I  | 52255-102C1   | 52255-102C9   | 52255-102C10   | 52255-102C17  | 52255-102C3   | 52255-102C4   |
|  | 5MM      | 36CM   | 52236-102I  | 52236-102C1   | 52236-102C9   | 52236-102C10   | 52236-102C17  | 52236-102C3   | 52236-102C4   |
|  | 5MM      | 45CM   | 52155-102I  | 52155-102C1   | 52155-102C9   | 52155-102C10   | 52155-102C17  | 52155-102C3   | 52155-102C4   |













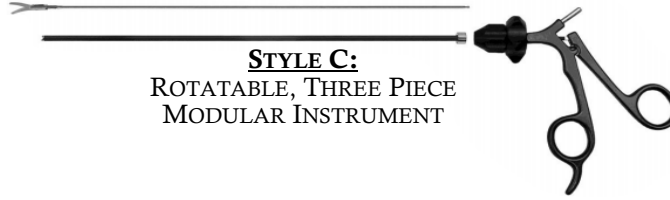





# 5MM SCISSORS & BIOPSY FORCEPS



MADE IN THE USA

**STYLE C:**  
ROTATABLE, THREE PIECE  
MODULAR INSTRUMENT

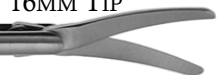

| TIP ID & LENGTH   | HANDLE   |        | INSERT ONLY | TYPE 1  | TYPE 9  | TYPE 17  | TYPE 23   | TYPE 3  | TYPE 16   |
|---|----------|--------|-------------|---|---|--|---|---|---|
|   | DIAMETER | LENGTH |             |  |  |  |  |  |  |
|   |          |        |             | INSULATED HANDLES   |   |  |   | NON-INSULATED   |   |
| <b>HOOKE SCISSORS, SA 10MM TIP</b><br>                              | 5MM      | 24CM   | 52224-60I   | 52224-60C1  | 52224-60C9  | 52224-60C17  | 52224-60C23   | 52224-60C3  | 52224-60C16   |
|   | 5MM      | 33CM   | 52255-60I   | 52255-60C1  | 52255-60C9  | 52255-60C17  | 52255-60C23   | 52255-60C3  | 52255-60C16   |
|   | 5MM      | 36CM   | 52236-60I   | 52236-60C1  | 52236-60C9  | 52236-60C17  | 52236-60C23   | 52236-60C3  | 52236-60C16   |
|   | 5MM      | 45CM   | 52155-60I   | 52155-60C1  | 52155-60C9  | 52155-60C17  | 52155-60C23   | 52155-60C3  | 52155-60C16   |
| <b>MICRO TIP SCISSORS, STRAIGHT, SA 5MM TIP</b><br>                 | 5MM      | 24CM   | 52224-61I   | 52224-61C1  | 52224-61C9  | 52224-61C17  | 52224-61C23   | 52224-61C3  | 52224-61C16   |
|   | 5MM      | 33CM   | 52255-61I   | 52255-61C1  | 52255-61C9  | 52255-61C17  | 52255-61C23   | 52255-61C3  | 52255-61C16   |
|   | 5MM      | 36CM   | 52236-61I   | 52236-61C1  | 52236-61C9  | 52236-61C17  | 52236-61C23   | 52236-61C3  | 52236-61C16   |
|   | 5MM      | 45CM   | 52155-61I   | 52155-61C1  | 52155-61C9  | 52155-61C17  | 52155-61C23   | 52155-61C3  | 52155-61C16   |
| <b>MICRO TIP SCISSORS, CURVED, SA 5MM TIP</b><br>                 | 5MM      | 24CM   | 52224-62I   | 52224-62C1  | 52224-62C9  | 52224-62C17  | 52224-62C23   | 52224-62C3  | 52224-62C16   |
|   | 5MM      | 33CM   | 52255-62I   | 52255-62C1  | 52255-62C9  | 52255-62C17  | 52255-62C23   | 52255-62C3  | 52255-62C16   |
|   | 5MM      | 36CM   | 52236-62I   | 52236-62C1  | 52236-62C9  | 52236-62C17  | 52236-62C23   | 52236-62C3  | 52236-62C16   |
|   | 5MM      | 45CM   | 52155-62I   | 52155-62C1  | 52155-62C9  | 52155-62C17  | 52155-62C23   | 52155-62C3  | 52155-62C16   |
| <b>METZENBAUM SCISSORS, STRAIGHT, LONG BLADE 20MM TIP</b><br>     | 5MM      | 24CM   | 52224-63I   | 52224-63C1  | 52224-63C9  | 52224-63C17  | 52224-63C23   | 52224-63C3  | 52224-63C16   |
|   | 5MM      | 33CM   | 52255-63I   | 52255-63C1  | 52255-63C9  | 52255-63C17  | 52255-63C23   | 52255-63C3  | 52255-63C16   |
|   | 5MM      | 36CM   | 52236-63I   | 52236-63C1  | 52236-63C9  | 52236-63C17  | 52236-63C23   | 52236-63C3  | 52236-63C16   |
|   | 5MM      | 45CM   | 52155-63I   | 52155-63C1  | 52155-63C9  | 52155-63C17  | 52155-63C23   | 52155-63C3  | 52155-63C16   |
| <b>METZENBAUM SCISSORS, STRAIGHT, SHORT BLADE 12MM TIP</b><br>    | 5MM      | 24CM   | 52224-64I   | 52224-64C1  | 52224-64C9  | 52224-64C17  | 52224-64C23   | 52224-64C3  | 52224-64C16   |
|   | 5MM      | 33CM   | 52255-64I   | 52255-64C1  | 52255-64C9  | 52255-64C17  | 52255-64C23   | 52255-64C3  | 52255-64C16   |
|   | 5MM      | 36CM   | 52236-64I   | 52236-64C1  | 52236-64C9  | 52236-64C17  | 52236-64C23   | 52236-64C3  | 52236-64C16   |
|   | 5MM      | 45CM   | 52155-64I   | 52155-64C1  | 52155-64C9  | 52155-64C17  | 52155-64C23   | 52155-64C3  | 52155-64C16   |
| <b>METZENBAUM SCISSORS, CURVED, LONG BLADE 16MM TIP</b><br>       | 5MM      | 24CM   | 52224-65I   | 52224-65C1  | 52224-65C9  | 52224-65C17  | 52224-65C23   | 52224-65C3  | 52224-65C16   |
|   | 5MM      | 33CM   | 52255-65I   | 52255-65C1  | 52255-65C9  | 52255-65C17  | 52255-65C23   | 52255-65C3  | 52255-65C16   |
|   | 5MM      | 36CM   | 52236-65I   | 52236-65C1  | 52236-65C9  | 52236-65C17  | 52236-65C23   | 52236-65C3  | 52236-65C16   |
|   | 5MM      | 45CM   | 52155-65I   | 52155-65C1  | 52155-65C9  | 52155-65C17  | 52155-65C23   | 52155-65C3  | 52155-65C16   |
| <b>METZENBAUM SCISSORS, WONDER CUT, CURVED BLADE 20MM TIP</b><br> | 5MM      | 24CM   | 52224-265I  | 52224-265C1   | 52224-265C9   | 52224-265C17   | 52224-265C23  | 52224-265C3   | 52224-265C16  |
|   | 5MM      | 33CM   | 52255-265I  | 52255-265C1   | 52255-265C9   | 52255-265C17   | 52255-265C23  | 52255-265C3   | 52255-265C16  |
|   | 5MM      | 36CM   | 52236-265I  | 52236-265C1   | 52236-265C9   | 52236-265C17   | 52236-265C23  | 52236-265C3   | 52236-265C16  |
|   | 5MM      | 45CM   | 52155-265I  | 52155-265C8   | 52155-265C9   | 52155-265C17   | 52155-265C23  | 52155-265C3   | 52155-265C16  |





# 5MM SCISSORS & BIOPSY FORCEPS



MADE IN THE USA

**STYLE C:**  
ROTATABLE, THREE PIECE  
MODULAR INSTRUMENT

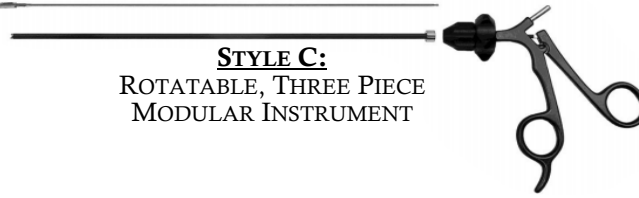

| TIP ID & LENGTH  | HANDLE   |        | INSERT ONLY | TYPE 1            | TYPE 9      | TYPE 17      | TYPE 23      | TYPE 3        | TYPE 16      |
|--|----------|--------|-------------|-------------------|-------------|--------------|--------------|---------------|--------------|
|  | DIAMETER | LENGTH |             |                   |             |              |              |               |              |
|  |          |        |             | INSULATED HANDLES |             |              |              | NON-INSULATED |              |
| <b>METZENBAUM SCISSORS, CURVED, SHORT BLADE 12MM TIP</b><br>       | 5MM      | 24CM   | 52224-66I   | 52224-66C1        | 52224-66C9  | 52224-66C17  | 52224-66C23  | 52224-66C3    | 52224-66C16  |
|  | 5MM      | 33CM   | 52255-66I   | 52255-66C1        | 52255-66C9  | 52255-66C17  | 52255-66C23  | 52255-66C3    | 52255-66C16  |
|  | 5MM      | 36CM   | 52236-66I   | 52236-66C1        | 52236-66C9  | 52236-66C17  | 52236-66C23  | 52236-66C3    | 52236-66C16  |
|  | 5MM      | 45CM   | 52155-66I   | 52155-66C1        | 52155-66C9  | 52155-66C17  | 52155-66C23  | 52155-66C3    | 52155-66C16  |
| <b>PERITONEAL SCISSORS, SA 15MM TIP</b><br>                        | 5MM      | 24CM   | 52224-67I   | 52224-67C1        | 52224-67C9  | 52224-67C17  | 52224-67C23  | 52224-67C3    | 52224-67C16  |
|  | 5MM      | 33CM   | 52255-67I   | 52255-67C1        | 52255-67C9  | 52255-67C17  | 52255-67C23  | 52255-67C3    | 52255-67C16  |
|  | 5MM      | 36CM   | 52236-67I   | 52236-67C1        | 52236-67C9  | 52236-67C17  | 52236-67C23  | 52236-67C3    | 52236-67C16  |
|  | 5MM      | 45CM   | 52155-67I   | 52155-67C1        | 52155-67C9  | 52155-67C17  | 52155-67C23  | 52155-67C3    | 52155-67C16  |
| <b>BIOPSY SPOON FORCEPS W/ TOOTH</b><br>                           | 5MM      | 24CM   | 52224-79I   | 52224-79C1        | 52224-79C9  | 52224-79C17  | 52224-79C23  | 52224-79C3    | 52224-79C16  |
|  | 5MM      | 33CM   | 52255-79I   | 52255-79C1        | 52255-79C9  | 52255-79C17  | 52255-79C23  | 52255-79C3    | 52255-79C16  |
|  | 5MM      | 36CM   | 52236-79I   | 52236-79C1        | 52236-79C9  | 52236-79C17  | 52236-79C23  | 52236-79C3    | 52236-79C16  |
|  | 5MM      | 45CM   | 52155-79I   | 52155-79C1        | 52155-79C9  | 52155-79C17  | 52155-79C23  | 52155-79C3    | 52155-79C16  |
| <b>BIOPSY SPOON FORCEPS, SHORT, SA 10MM TIP</b><br>                | 5MM      | 24CM   | 52224-69I   | 52224-69C1        | 52224-69C9  | 52224-69C17  | 52224-69C23  | 52224-69C3    | 52224-69C16  |
|  | 5MM      | 33CM   | 52255-69I   | 52255-69C1        | 52255-69C9  | 52255-69C17  | 52255-69C23  | 52255-69C3    | 52255-69C16  |
|  | 5MM      | 36CM   | 52236-69I   | 52236-69C1        | 52236-69C9  | 52236-69C17  | 52236-69C23  | 52236-69C3    | 52236-69C16  |
|  | 5MM      | 45CM   | 52155-69I   | 52155-69C1        | 52155-69C9  | 52155-69C17  | 52155-69C23  | 52155-69C3    | 52155-69C16  |
| <b>POINTED BIOPSY SPOON FORCEPS, SA 10MM TIP</b><br>               | 5MM      | 24CM   | 52224-305I  | 52224-305C1       | 52224-305C9 | 52224-305C17 | 52224-305C23 | 52224-305C3   | 52224-305C16 |
|  | 5MM      | 33CM   | 52255-305I  | 52255-305C1       | 52255-305C9 | 52255-305C17 | 52255-305C23 | 52255-305C3   | 52255-305C16 |
|  | 5MM      | 36CM   | 52236-305I  | 52236-305C1       | 52236-305C9 | 52236-305C17 | 52236-305C23 | 52236-305C3   | 52236-305C16 |
|  | 5MM      | 45CM   | 52155-305I  | 52155-305C1       | 52155-305C9 | 52155-305C17 | 52155-305C23 | 52155-305C3   | 52155-305C16 |
| <b>BIOPSY SPOON FORCEPS, DA 10MM TIP</b><br>                       | 5MM      | 24CM   | 52224-70I   | 52224-70C1        | 52224-70C9  | 52224-70C17  | 52224-70C23  | 52224-70C3    | 52224-70C16  |
|  | 5MM      | 33CM   | 52255-70I   | 52255-70C1        | 52255-70C9  | 52255-70C17  | 52255-70C23  | 52255-70C3    | 52255-70C16  |
|  | 5MM      | 36CM   | 52236-70I   | 52236-70C1        | 52236-70C9  | 52236-70C17  | 52236-70C23  | 52236-70C3    | 52236-70C16  |
|  | 5MM      | 45CM   | 52155-70I   | 52155-70C1        | 52155-70C9  | 52155-70C17  | 52155-70C23  | 52155-70C3    | 52155-70C16  |
| <b>BIOPSY SPOON FORCEPS, W/ TOOTH (SEMM-TYPE) D/A 10MM TIP</b><br> | 5MM      | 24CM   | 52224-68I   | 52224-68C1        | 52224-68C9  | 52224-68C17  | 52224-68C23  | 52224-68C3    | 52224-68C16  |
|  | 5MM      | 33CM   | 52255-68I   | 52255-68C1        | 52255-68C9  | 52255-68C17  | 52255-68C23  | 52255-68C3    | 52255-68C16  |
|  | 5MM      | 36CM   | 52236-68I   | 52236-68C1        | 52236-68C9  | 52236-68C17  | 52236-68C23  | 52236-68C3    | 52236-68C16  |
|  | 5MM      | 45CM   | 52155-68I   | 52155-68C1        | 52155-68C9  | 52155-68C17  | 52155-68C23  | 52155-68C3    | 52155-68C16  |











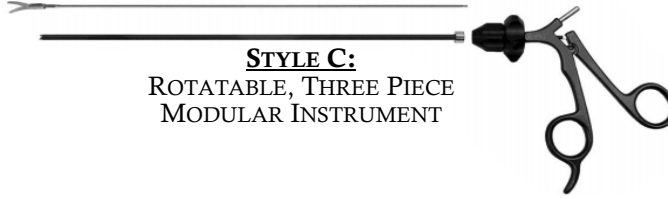

# 5MM SCISSORS & BIOPSY FORCEPS



MADE IN THE USA

**STYLE C:**  
ROTATABLE, THREE PIECE  
MODULAR INSTRUMENT



| TIP ID<br>&<br>LENGTH  | HANDLE ID |        | INSERT ONLY | TYPE 1  | TYPE 9  | TYPE 17  | TYPE 23   | TYPE 3  | TYPE 16   |
|--|-----------|--------|-------------|---|---|--|---|---|---|
|  | DIAMETER  | LENGTH |             |  |  |  |  |  |  |
|  |           |        |             | INSULATED HANDLES   |   |  |   | NON-INSULATED   |   |
| BIOPSY PUNCH,<br>SA<br>10MM TIP<br><br>            | 5MM       | 24CM   | 52224-71C1  | 52224-71C8  | 52224-71C9  | 52224-71C17  | 52224-71C23   | 52224-71C3  | 52224-71C16   |
|  | 5MM       | 33CM   | 52255-71C1  | 52255-71C8  | 52255-71C9  | 52255-71C17  | 52255-71C23   | 52255-71C3  | 52255-71C16   |
|  | 5MM       | 36CM   | 52236-71C1  | 52236-71C8  | 52236-71C9  | 52236-71C17  | 52236-71C23   | 52236-71C3  | 52236-71C16   |
|  | 5MM       | 45CM   | 52155-71C1  | 52155-71C8  | 52155-71C9  | 52155-71C17  | 52155-71C23   | 52155-71C3  | 52155-71C16   |
| BIOPSY PUNCH<br>W/ TOOTH, SA<br>10MM TIP<br><br> | 5MM       | 24CM   | 52224-72C1  | 52224-72C8  | 52224-72C9  | 52224-72C17  | 52224-72C23   | 52224-72C3  | 52224-72C16   |
|  | 5MM       | 33CM   | 52255-72C1  | 52255-72C8  | 52255-72C9  | 52255-72C17  | 52255-72C23   | 52255-72C3  | 52255-72C16   |
|  | 5MM       | 36CM   | 52236-72C1  | 52236-72C8  | 52236-72C9  | 52236-72C17  | 52236-72C23   | 52236-72C3  | 52236-72C16   |
|  | 5MM       | 45CM   | 52155-72C1  | 52155-72C8  | 52155-72C9  | 52155-72C17  | 52155-72C23   | 52155-72C3  | 52155-72C16   |

















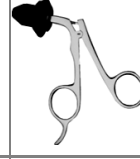

# 10MM DISSECTORS & GRASPERS



MADE IN THE USA

**STYLE C:**  
ROTATABLE, THREE PIECE  
MODULAR INSTRUMENT



| TIP ID & LENGTH   | HANDLE ID |        | INSERT ONLY | TYPE 1  | TYPE 9  | TYPE 10  | TYPE 17   | TYPE 3  | TYPE 4  |
|---|-----------|--------|-------------|---|---|--|---|---|---|
|   | DIAMETER  | LENGTH |             |  |  |  |  |  |  |
|   |           |        |             | INSULATED HANDLES   |   |  |   | NON-INSULATED   |   |
| <b>MARYLAND DISSECTOR</b><br>18MM TIP<br>                       | 10MM      | 33CM   | 52102-06I   | 52102-06C1  | 52102-06C9  | 52102-06C10  | 52102-06C17   | 52102-06C3  | 52102-06C4  |
|   | 10MM      | 36CM   | 52103-06I   | 52103-06C1  | 52103-06C9  | 52103-06C10  | 52103-06C17   | 52103-06C3  | 52103-06C4  |
|   | 10MM      | 45CM   | 52101-06I   | 52101-06C1  | 52101-06C9  | 52101-06C10  | 52101-06C17   | 52101-06C3  | 52101-06C4  |
| <b>RIGHT ANGLE MIXTER, LONG, TEFLON INSERTS</b><br>22MM TIP<br> | 10MM      | 33CM   | 52102-07I   | 52102-07C1  | 52102-07C9  | 52102-07C10  | 52102-07C17   | 52102-07C3  | 52102-07C4  |
|   | 10MM      | 36CM   | 52103-07I   | 52103-07C1  | 52103-07C9  | 52103-07C10  | 52103-07C17   | 52103-07C3  | 52103-07C4  |
|   | 10MM      | 45CM   | 52101-07I   | 52101-07C1  | 52101-07C9  | 52101-07C10  | 52101-07C17   | 52101-07C3  | 52101-07C4  |
| <b>RIGHT ANGLE MIXTER, SHORT</b><br>12MM TIP<br>               | 10MM      | 33CM   | 52102-59I   | 52102-59C1  | 52102-59C9  | 52102-59C10  | 52102-59C17   | 52102-59C3  | 52102-59C4  |
|   | 10MM      | 36CM   | 52103-59I   | 52103-59C1  | 52103-59C9  | 52103-59C10  | 52103-59C17   | 52103-59C3  | 52103-59C4  |
|   | 10MM      | 45CM   | 52101-59I   | 52101-59C1  | 52101-59C9  | 52101-59C10  | 52101-59C17   | 52101-59C3  | 52101-59C4  |
| <b>45° ANGLED MIXTER</b><br>20MM TIP<br>                      | 10MM      | 33CM   | 52102-08I   | 52102-08C1  | 52102-08C9  | 52102-08C10  | 52102-08C17   | 52102-08C3  | 52102-08C4  |
|   | 10MM      | 36CM   | 52103-08I   | 52103-08C1  | 52103-08C9  | 52103-08C10  | 52103-08C17   | 52103-08C3  | 52103-08C4  |
|   | 10MM      | 45CM   | 52101-08CI  | 52101-08C1  | 52101-08C9  | 52101-08C10  | 52101-08C17   | 52101-08C3  | 52101-08C4  |
| <b>BABCOCK GRASPER, FENESTRATED TIP</b><br>30MM TIP<br>       | 10MM      | 33CM   | 52102-16I   | 52102-16A1  | 52102-16C9  | 52102-16C10  | 52102-16C17   | 52102-16C3  | 52102-16C4  |
|   | 10MM      | 36CM   | 52103-16I   | 52103-16C1  | 52103-16C9  | 52103-16C10  | 52103-16C17   | 52103-16C3  | 52103-16C4  |
|   | 10MM      | 45CM   | 52101-16I   | 52101-16C1  | 52101-16C9  | 52101-16C10  | 52101-16C17   | 52101-16C3  | 52101-16C4  |
| <b>ALLIS GRASPER, STD. VERSION</b><br>30MM TIP<br>           | 10MM      | 33CM   | 52102-21I   | 52102-21C1  | 52102-21C9  | 52102-21C10  | 52102-21C17   | 52102-21C3  | 52102-21C4  |
|   | 10MM      | 36CM   | 52103-21I   | 52103-21C1  | 52103-21C9  | 52103-21C10  | 52103-21C17   | 52103-21C3  | 52103-21C4  |
|   | 10MM      | 45CM   | 52101-21I   | 52101-21C1  | 52101-21C9  | 52101-21C10  | 52101-21C17   | 52101-21C3  | 52101-21C4  |
| <b>DEBAKEY GRASPER, 40MM TIP</b><br>                         | 10MM      | 33CM   | 52102-22I   | 52102-22C1  | 52102-22C9  | 52102-22C10  | 52102-22C17   | 52102-22C3  | 52102-22C4  |
|   | 10MM      | 36CM   | 52103-22I   | 52103-22C1  | 52103-22C9  | 52103-22C10  | 52103-22C17   | 52103-22C3  | 52103-22C4  |
|   | 10MM      | 45CM   | 52101-22I   | 52101-22C1  | 52101-22C9  | 52101-22C10  | 52101-22C17   | 52101-22C3  | 52101-22C4  |
| <b>DEBAKEY GRASPER, 60MM TIP</b><br>                          | 10MM      | 33CM   | 52102-23I   | 52102-23C1  | 52102-23C9  | 52102-23C10  | 52102-23C17   | 52102-23C3  | 52102-23C4  |
|   | 10MM      | 36CM   | 52103-23I   | 52103-23C1  | 52103-23C9  | 52103-23C10  | 52103-23C17   | 52103-23C3  | 52103-23C4  |
|   | 10MM      | 45CM   | 52101-23I   | 52101-23C1  | 52101-23C9  | 52101-23C10  | 52101-23C17   | 52101-23C3  | 52101-23C4  |
| <b>CLAW GRASPER, 2X3 TEETH, SA</b><br>20MM TIP<br>            | 10MM      | 33CM   | 52102-36I   | 52102-36C1  | 52102-36C9  | 52102-36C10  | 52102-36C17   | 52102-36C3  | 52102-36C4  |
|   | 10MM      | 36CM   | 52103-36I   | 52103-36C1  | 52103-36C9  | 52103-36C10  | 52103-36C17   | 52103-36C3  | 52103-36C4  |
|   | 10MM      | 45CM   | 52101-36I   | 52101-36C1  | 52101-36C9  | 52101-36C10  | 52101-36C17   | 52101-36C3  | 52101-36C4  |









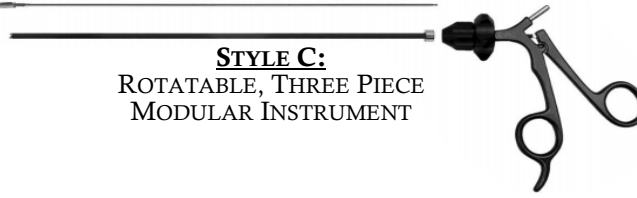





# 10MM DISSECTORS & GRASPERS

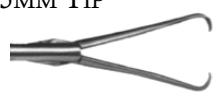

MADE IN THE USA



| TIP ID & LENGTH   | HANDLE ID |        | INSERT ONLY | TYPE 1  | TYPE 9  | TYPE 10  | TYPE 17   | TYPE 3  | TYPE 4  |
|---|-----------|--------|-------------|---|---|--|---|---|---|
|   | DIAMETER  | LENGTH |             |  |  |  |  |  |  |
|   |           |        |             | INSULATED HANDLES   |   |  |   | NON-INSULATED   |   |
| <b>SCHROEDER TEN, SINGLE TOOTH 25MM TIP</b><br>               | 10MM      | 33CM   | 52102-45I   | 52102-45C8  | 52102-45C9  | 52102-45C10  | 52102-45C17   | 52102-45C3  | 52102-45C4  |
|   | 10MM      | 36CM   | 52103-45I   | 52103-45C8  | 52103-45C9  | 52103-45C10  | 52103-45C17   | 52103-45C3  | 52103-45C4  |
|   | 10MM      | 45CM   | 52101-45I   | 52101-45C8  | 52101-45C9  | 52101-45C10  | 52101-45C17   | 52101-45C3  | 52101-45C4  |
| <b>US BABCOCK, SPRING TENSION, ATRAUMATIC 22MM TIP</b><br>   | 10MM      | 33CM   | 52102-17I   | 52102-17C8  | 52102-17C9  | 52102-17C10  | 52102-17C17   | 52102-17C3  | 52102-17C4  |
|   | 10MM      | 36CM   | 52103-17I   | 52103-17C8  | 52103-17C9  | 52103-17C10  | 52103-17C17   | 52103-17C3  | 52103-17C4  |
|   | 10MM      | 45CM   | 52101-17I   | 52101-17C8  | 52101-17C9  | 52101-17C10  | 52101-17C17   | 52101-17C3  | 52101-17C4  |
| <b>DUVAL GRASPER, AXIAL SERRATIONS 40MM TIP</b><br>         | 10MM      | 33CM   | 52102-26I   | 52102-26C8  | 52102-26C9  | 52102-26C10  | 52102-26C17   | 52102-26C3  | 52102-26C4  |
|   | 10MM      | 36CM   | 52103-26I   | 52103-26C8  | 52103-26C9  | 52103-26C10  | 52103-26C17   | 52103-26C3  | 52103-26C4  |
|   | 10MM      | 45CM   | 52101-26I   | 52101-26C8  | 52101-26C9  | 52101-26C10  | 52101-26C17   | 52101-26C3  | 52101-26C4  |
| <b>STRONG ATRAUMATIC CLAMP, STRAIGHT JAW 40MM TIP</b><br>   | 10MM      | 33CM   | 52102-46I   | 52102-46C8  | 52102-46C9  | 52102-46C10  | 52102-46C17   | 52102-46C3  | 52102-46C4  |
|   | 10MM      | 36CM   | 52103-46I   | 52103-46C8  | 52103-46C9  | 52103-46C10  | 52103-46C17   | 52103-46C3  | 52103-46C4  |
|   | 10MM      | 45CM   | 52101-46I   | 52101-46C8  | 52101-46C9  | 52101-46C10  | 52101-46C17   | 52101-46C3  | 52101-46C4  |
| <b>STRONG ATRAUMATIC CLAMP, CURVED JAW 40MM TIP</b><br>     | 10MM      | 33CM   | 52102-47I   | 52102-47C8  | 52102-47C9  | 52102-47C10  | 52102-47C17   | 52102-47C3  | 52102-47C4  |
|   | 10MM      | 36CM   | 52103-47I   | 52103-47C8  | 52103-47C9  | 52103-47C10  | 52103-47C17   | 52103-47C3  | 52103-47C4  |
|   | 10MM      | 45CM   | 52101-47I   | 52101-47C8  | 52101-47C9  | 52101-47C10  | 52101-47C17   | 52101-47C3  | 52101-47C4  |
| <b>ANVIL GRASPER TO GRASP &amp; HOLD ANVIL 10MM TIP</b><br> | 10MM      | 33CM   | 52102-20I   | 52102-20C8  | 52102-20C9  | 52102-20C10  | 52102-20C17   | 52102-20C3  | 52102-20C4  |
|   | 10MM      | 36CM   | 52103-20I   | 52103-20C8  | 52103-20C9  | 52103-20C10  | 52103-20C17   | 52103-20C3  | 52103-20C4  |
|   | 10MM      | 45CM   | 52101-20I   | 52101-20C8  | 52101-20C9  | 52101-20C10  | 52101-20C17   | 52101-20C3  | 52101-20C4  |









# 10MM DISSECTORS & GRASPERS

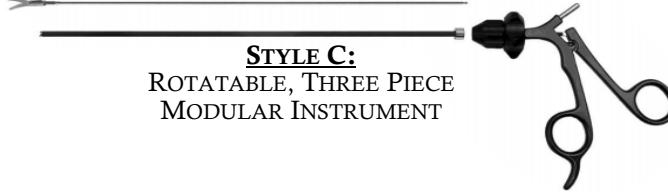

MADE IN THE USA

**STYLE C:**  
ROTATABLE, THREE PIECE  
MODULAR INSTRUMENT



| TIP ID<br>&<br>LENGTH   | HANDLE ID |        | INSERT ONLY | TYPE 1            | TYPE 9     | TYPE 17     | TYPE 23     | TYPE 3        | TYPE 16    |
|---|-----------|--------|-------------|-------------------|------------|-------------|-------------|---------------|------------|
|   | DIAMETER  | LENGTH |             | INSULATED HANDLES |            |             |             | NON-INSULATED |            |
|   |           |        |             | INSULATED HANDLES |            |             |             | NON-INSULATED |            |
| STRAIGHT<br>SCISSORS, SA<br>20MM TIP<br>                | 10MM      | 33CM   | 52102-64I   | 52102-64C1        | 52102-64C9 | 52102-64C10 | 52102-64C17 | 52102-64C3    | 52102-64C4 |
|   | 10MM      | 36CM   | 52103-64I   | 52103-64C1        | 52103-64C9 | 52103-64C10 | 52103-64C17 | 52103-64C3    | 52103-64C4 |
|   | 10MM      | 45CM   | 52101-64I   | 52101-64C1        | 52101-64C9 | 52101-64C10 | 52101-64C17 | 52101-64C3    | 52101-64C4 |
| CURVED SCISSORS,<br>DA 20MM TIP<br>                    | 10MM      | 33CM   | 52102-66I   | 52102-66C1        | 52102-66C9 | 52102-66C10 | 52102-66C17 | 52102-66C3    | 52102-66C4 |
|   | 10MM      | 36CM   | 52103-66I   | 52103-66C1        | 52103-66C9 | 52103-66C10 | 52103-66C17 | 52103-66C3    | 52103-66C4 |
|   | 10MM      | 45CM   | 52101-66I   | 52101-66C1        | 52101-66C9 | 52101-66C10 | 52101-66C17 | 52101-66C3    | 52101-66C4 |
| BIOPSY SPOON<br>FORCEPS, SHORT,<br>SA<br>10MM TIP<br> | 10MM      | 33CM   | 52102-37I   | 52102-37C1        | 52102-37C9 | 52102-37C10 | 52102-37C17 | 52102-37C3    | 52102-37C4 |
|   | 10MM      | 36CM   | 52103-37I   | 52103-37C1        | 52103-37C9 | 52103-37C10 | 52103-37C17 | 52103-37C3    | 52103-37C4 |
|   | 10MM      | 45CM   | 52101-37I   | 52101-37C1        | 52101-37C9 | 52101-37C10 | 52101-37C17 | 52101-37C3    | 52101-37C4 |
| BIOPSY SPOON<br>FORCEPS, LONG,<br>SA<br>25MM TIP<br>  | 10MM      | 33CM   | 52102-38I   | 52102-38C1        | 52102-38C9 | 52102-38C10 | 52102-38C17 | 52102-38C3    | 52102-38C4 |
|   | 10MM      | 36CM   | 52103-38I   | 52103-38C1        | 52103-38C9 | 52103-38C10 | 52103-38C17 | 52103-38C3    | 52103-38C4 |
|   | 10MM      | 45CM   | 52101-38I   | 52101-38C1        | 52101-38C9 | 52101-38C10 | 52101-38C17 | 52101-38C3    | 52101-38C4 |



# SURE-GRIP SERIES

## SURE-GRIP SLIDE-LOCK HANDLE GRASPERS *WHEN SLIPPING IS NOT AN OPTION*



THE SURE-GRIP 5MM & 10MM GRASPERS HAVE *POSITIVE, PRECISE ACTION* FOR SURE-GRIP GRASPING & RETRACTION.  
AVAILABLE IN ONE-PIECE RIGID, ONE-PIECE ROTATABLE & THREE-PIECE SCREW APART INSTRUMENTS

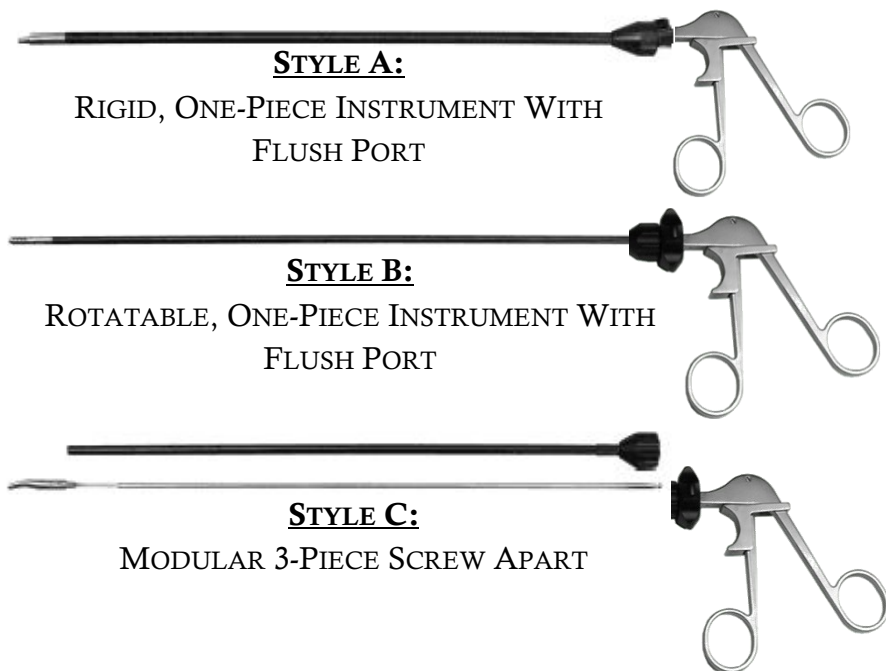



# GRASPERS



MADE IN THE USA

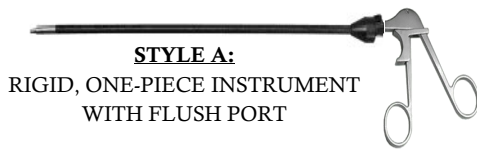



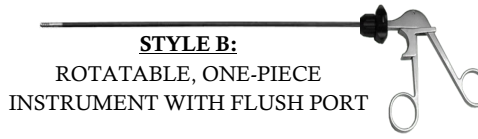



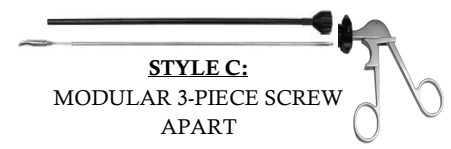

**STYLE A:**  
RIGID, ONE-PIECE INSTRUMENT  
WITH FLUSH PORT



**STYLE B:**  
ROTATABLE, ONE-PIECE  
INSTRUMENT WITH FLUSH PORT



**STYLE C:**  
MODULAR 3-PIECE SCREW  
APART

| TIP ID.  | DESCRIPTION                                       | DIAMETER | LENGTH | INSERT NO. | STYLE A:<br>RIGID, ONE-PIECE<br>INSTRUMENT<br>WITH FLUSH<br>PORT | STYLE B:<br>ROTATABLE,<br>ONE-PIECE<br>INSTRUMENT<br>WITH FLUSH<br>PORT | STYLE C:<br>MODULAR 3-PIECE SCREW<br>APART |
|--|---|----------|--------|------------|--|---|--|
| <br>12MM JAW   | STANDARD<br>GRASPER W/<br>SPOON                   | 5MM      | 24CM   | 52224-02I  | 52624-02A  | 52624-02B   | 52624-02C                                  |
|  |   | 5MM      | 33CM   | 52255-02I  | 52605-02A  | 52605-02B   | 52605-02C                                  |
|  |   | 5MM      | 36CM   | 52236-02I  | 52636-02A  | 52636-02B   | 52636-02C                                  |
|  |   | 5MM      | 45CM   | 52155-02I  | 52615-02A  | 52615-02B   | 52615-02C                                  |
| <br>12MM JAW   | STANDARD<br>GRASPER                               | 5MM      | 24CM   | 52224-03I  | 52624-03A  | 52624-03B   | 52624-03C                                  |
|  |   | 5MM      | 33CM   | 52255-03I  | 52605-03A  | 52605-03B   | 52605-03C                                  |
|  |   | 5MM      | 36CM   | 52236-03I  | 52636-03A  | 52636-03B   | 52636-03C                                  |
|  |   | 5MM      | 45CM   | 52155-03I  | 52615-03A  | 52615-03B   | 52615-03C                                  |
| <br>15MM JAW  | TAPERED<br>DOLPHIN-NOSE                           | 5MM      | 24CM   | 52224-05I  | 52624-05A  | 52624-05B   | 52624-05C                                  |
|  |   | 5MM      | 33CM   | 52255-05I  | 52605-05A  | 52605-05B   | 52605-05C                                  |
|  |   | 5MM      | 36CM   | 52236-05I  | 52636-05A  | 52636-05B   | 52636-05C                                  |
|  |   | 5MM      | 45CM   | 52155-05I  | 52615-05A  | 52615-05B   | 52615-05C                                  |
| <br>12MM JAW | TAPERED<br>DOLPHIN-NOSE<br>W/ SPOON               | 5MM      | 24CM   | 52224-105I | 52624-105A   | 52624-105B  | 52624-105C                                 |
|  |   | 5MM      | 33CM   | 52255-105I | 52605-105A   | 52605-105B  | 52605-105C                                 |
|  |   | 5MM      | 36CM   | 52236-105I | 52636-105A   | 52636-105B  | 52636-105C                                 |
|  |   | 5MM      | 45CM   | 52155-105I | 52615-105A   | 52615-105B  | 52615-105C                                 |
| <br>10MM JAW | COBRA<br>GRASPER, DA                              | 5MM      | 24CM   | 52224-15I  | 52624-15A  | 52624-15B   | 52624-15C                                  |
|  |   | 5MM      | 33CM   | 52255-15I  | 52605-15A  | 52605-15B   | 52605-15C                                  |
|  |   | 5MM      | 36CM   | 52236-15I  | 52636-15A  | 52636-15B   | 52636-15C                                  |
|  |   | 5MM      | 45CM   | 52155-15I  | 52615-15A  | 52615-15B   | 52615-15C                                  |
| <br>30MM JAW | BABCOCK<br>GRASPER,<br>FENESTRATED TIP            | 5MM      | 24CM   | 52224-16I  | 52624-16A  | 52624-16B   | 52624-16C                                  |
|  |   | 5MM      | 33CM   | 52255-16I  | 52605-16A  | 52605-16B   | 52605-16C                                  |
|  |   | 5MM      | 36CM   | 52236-16I  | 52636-16A  | 52636-16B   | 52636-16C                                  |
|  |   | 5MM      | 45CM   | 52155-16I  | 52615-16A  | 52615-16B   | 52615-16C                                  |
| <br>30MM JAW | BABCOCK<br>GRASPER, AXIS<br>STYLE,<br>FENESTRATED | 5MM      | 24CM   | 52224-116I | 52624-116A   | 52624-116B  | 52624-116C                                 |
|  |   | 5MM      | 33CM   | 52255-116I | 52605-116A   | 52605-116B  | 52605-116C                                 |
|  |   | 5MM      | 36CM   | 52236-116I | 52636-116A   | 52636-116B  | 52636-116C                                 |
|  |   | 5MM      | 45CM   | 52155-116I | 52615-116A   | 52615-116B  | 52615-116C                                 |
| <br>10MM JAW | BABCOCK<br>GRASPER, SHORT<br>DELICATE             | 5MM      | 24CM   | 52224-17I  | 52624-17A  | 52624-17B   | 52624-17C                                  |
|  |   | 5MM      | 33CM   | 52255-17I  | 52605-17A  | 52605-17B   | 52605-17C                                  |
|  |   | 5MM      | 36CM   | 52236-17I  | 52636-17A  | 52636-17B   | 52636-17C                                  |
|  |   | 5MM      | 45CM   | 52155-17I  | 52615-17A  | 52615-17B   | 52615-17C                                  |





# GRASPERS



MADE IN THE USA

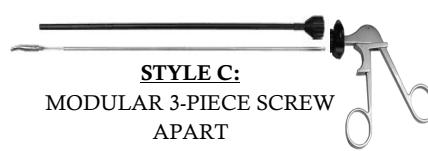
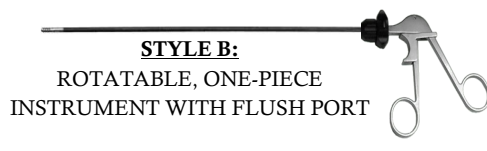
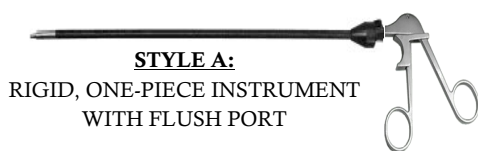

| TIP ID.  | DESCRIPTION   | DIAMETER | LENGTH | INSERT NO. | STYLE A:<br>RIGID, ONE-PIECE<br>INSTRUMENT<br>WITH FLUSH<br>PORT | STYLE B:<br>ROTATABLE,<br>ONE-PIECE<br>INSTRUMENT<br>WITH FLUSH<br>PORT | STYLE C:<br>MODULAR 3-<br>PIECE SCREW<br>APART |
|----------|---|----------|--------|------------|--|---|--|
| 15MM JAW | ALLIS GRASPER,<br>SHORT<br>VERSION, SA                        | 5MM      | 24CM   | 52224-18I  | 52624-18A  | 52624-18B   | 52624-18C                                      |
|          |   | 5MM      | 33CM   | 52255-18I  | 52605-18A  | 52605-18B   | 52605-18C                                      |
|          |   | 5MM      | 36CM   | 52236-18I  | 52636-18A  | 52636-18B   | 52636-18C                                      |
|          |   | 5MM      | 45CM   | 52155-18I  | 52615-18A  | 52615-18B   | 52615-18C                                      |
| 12MM JAW | ALLIS, SHORT<br>VERSION,<br>3X4 TEETH,<br>SERRATED            | 5MM      | 24CM   | 52224-19I  | 52624-19A  | 52624-19B   | 52624-19C                                      |
|          |   | 5MM      | 33CM   | 52255-19I  | 52605-19A  | 52605-19B   | 52605-19C                                      |
|          |   | 5MM      | 36CM   | 52236-19I  | 52636-19A  | 52636-19B   | 52636-19C                                      |
|          |   | 5MM      | 45CM   | 52155-19I  | 52615-19A  | 52615-19B   | 52615-19C                                      |
| 12MM JAW | ALLIS, SHORT<br>VERSION,<br>DBL. ROW OF<br>TEETH,<br>SERRATED | 5MM      | 24CM   | 52224-119I | 52624-119A   | 52624-119B  | 52624-119C                                     |
|          |   | 5MM      | 33CM   | 52255-119I | 52605-119A   | 52605-119B  | 52605-119C                                     |
|          |   | 5MM      | 36CM   | 52236-119I | 52636-119A   | 52636-119B  | 52636-119C                                     |
|          |   | 5MM      | 45CM   | 52155-119I | 52615-119A   | 52615-119B  | 52615-119C                                     |
| 25MM JAW | ALLIS, LONG<br>VERSION,<br>DBL. ROW OF<br>TEETH,<br>SERRATED  | 5MM      | 24CM   | 52224-219I | 52624-219A   | 52624-219B  | 52624-219C                                     |
|          |   | 5MM      | 33CM   | 52255-219I | 52605-219A   | 52605-219B  | 52605-219C                                     |
|          |   | 5MM      | 36CM   | 52236-219I | 52636-219A   | 52636-219B  | 52636-219C                                     |
|          |   | 5MM      | 45CM   | 52155-219I | 52615-219A   | 52615-219B  | 52615-219C                                     |
| 20MM JAW | ALLIS GRASPER,<br>MEDIUM, WECK<br>STYLE                       | 5MM      | 24CM   | 52224-20I  | 52624-20A  | 52624-20B   | 52624-20C                                      |
|          |   | 5MM      | 33CM   | 52255-20I  | 52605-20A  | 52605-20B   | 52605-20C                                      |
|          |   | 5MM      | 36CM   | 52236-20I  | 52636-20A  | 52636-20B   | 52636-20C                                      |
|          |   | 5MM      | 45CM   | 52155-20I  | 52615-20A  | 52615-20B   | 52615-20C                                      |
| 30MM JAW | ALLIS GRAPER, STD.<br>VERSION                                 | 5MM      | 24CM   | 52224-21I  | 52624-21A  | 52624-21B   | 52624-21C                                      |
|          |   | 5MM      | 33CM   | 52255-21I  | 52605-21A  | 52605-21B   | 52605-21C                                      |
|          |   | 5MM      | 36CM   | 52236-21I  | 52636-21A  | 52636-21B   | 52636-21C                                      |
|          |   | 5MM      | 45CM   | 52155-21I  | 52615-21A  | 52615-21B   | 52615-21C                                      |
| 35MM JAW | ALLIS GRASPER, TC,<br>STD. VERSION                            | 5MM      | 24CM   | 52224-57I  | 52624-57A  | 52624-57B   | 52624-57C                                      |
|          |   | 5MM      | 33CM   | 52255-57I  | 52605-57A  | 52605-57B   | 52605-57C                                      |
|          |   | 5MM      | 36CM   | 52236-57I  | 52636-57A  | 52636-57B   | 52636-57C                                      |
|          |   | 5MM      | 45CM   | 52155-57I  | 52615-57A  | 52615-57B   | 52615-57C                                      |
| 20MM JAW | DEBAKEY GRASPER   | 5MM      | 24CM   | 52224-22I  | 52624-22A  | 52624-22B   | 52624-22C                                      |
|          |   | 5MM      | 33CM   | 52255-22I  | 52605-22A  | 52605-22B   | 52605-22C                                      |
|          |   | 5MM      | 36CM   | 52236-22I  | 52636-22A  | 52636-22B   | 52636-22C                                      |
|          |   | 5MM      | 45CM   | 52155-22I  | 52615-22A  | 52615-22B   | 52615-22C                                      |





# GRASPERS



MADE IN THE USA

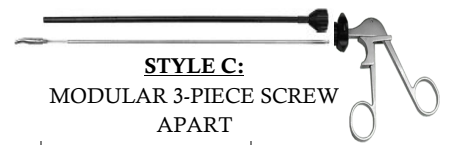
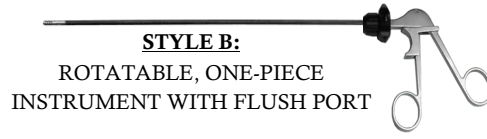
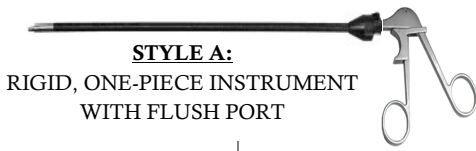

| TIP ID.  | DESCRIPTION                    | DIAMETER | LENGTH | INSERT NO. | STYLE A:<br>RIGID, ONE-PIECE<br>INSTRUMENT<br>WITH FLUSH<br>PORT | STYLE B:<br>ROTATABLE,<br>ONE-PIECE<br>INSTRUMENT<br>WITH FLUSH<br>PORT | STYLE C:<br>MODULAR 3-<br>PIECE SCREW<br>APART |
|----------|--------------------------------|----------|--------|------------|--|---|--|
| 40MM JAW | DEBAKEY GRASPER                | 5MM      | 24CM   | 52224-23I  | 52624-23A  | 52624-23B   | 52624-23C                                      |
|          |                                | 5MM      | 33CM   | 52255-23I  | 52605-23A  | 52605-23B   | 52605-23C                                      |
|          |                                | 5MM      | 36CM   | 52236-23I  | 52636-23A  | 52636-23B   | 52636-23C                                      |
|          |                                | 5MM      | 45CM   | 52155-23I  | 52615-23A  | 52615-23B   | 52615-23C                                      |
| 60MM JAW | DEBAKEY GRASPER                | 5MM      | 24CM   | 52224-123I | 52624-123A   | 52624-123B  | 52624-123C                                     |
|          |                                | 5MM      | 33CM   | 52255-123I | 52605-123A   | 52605-123B  | 52605-123C                                     |
|          |                                | 5MM      | 36CM   | 52236-123I | 52636-123A   | 52636-123B  | 52636-123C                                     |
|          |                                | 5MM      | 45CM   | 52155-123I | 52615-123A   | 52615-123B  | 52615-123C                                     |
| 20MM JAW | HUNTER DEBAKEY,<br>FENESTRATED | 5MM      | 24CM   | 52224-58I  | 52624-58A  | 52624-58B   | 52624-58C                                      |
|          |                                | 5MM      | 33CM   | 52255-58I  | 52605-58A  | 52605-58B   | 52605-58C                                      |
|          |                                | 5MM      | 36CM   | 52236-58I  | 52636-58A  | 52636-58B   | 52636-58C                                      |
|          |                                | 5MM      | 45CM   | 52155-58I  | 52615-58A  | 52615-58B   | 52615-58C                                      |
| 40MM JAW | HUNTER DEBAKEY,<br>FENESTRATED | 5MM      | 24CM   | 52224-159I | 52624-159A   | 52624-159B  | 52624-159C                                     |
|          |                                | 5MM      | 33CM   | 52255-159I | 52605-159A   | 52605-159B  | 52605-159C                                     |
|          |                                | 5MM      | 36CM   | 52236-159I | 52636-159A   | 52636-159B  | 52636-159C                                     |
|          |                                | 5MM      | 45CM   | 52155-159I | 52615-159A   | 52615-159B  | 52615-159C                                     |
| 60MM JAW | HUNTER DEBAKEY,<br>FENESTRATED | 5MM      | 24CM   | 52224-160I | 52624-160A   | 52624-160B  | 52624-160C                                     |
|          |                                | 5MM      | 33CM   | 52255-160I | 52605-160A   | 52605-160B  | 52605-160C                                     |
|          |                                | 5MM      | 36CM   | 52236-160I | 52636-160A   | 52636-160B  | 52636-160C                                     |
|          |                                | 5MM      | 45CM   | 52155-160I | 52615-160A   | 52615-160B  | 52615-160C                                     |
| 30MM JAW | DEBAKEY GRASPER,<br>CURVED     | 5MM      | 24CM   | 52224-46I  | 52624-46A  | 52624-46B   | 52624-46C                                      |
|          |                                | 5MM      | 33CM   | 52255-46I  | 52605-46A  | 52605-46B   | 52605-46C                                      |
|          |                                | 5MM      | 36CM   | 52236-46I  | 52636-46A  | 52636-46B   | 52636-46C                                      |
|          |                                | 5MM      | 45CM   | 52155-46I  | 52615-46A  | 52615-46B   | 52615-46C                                      |
| 35MM JAW | DEBAKEY MARYLAND<br>GRASPER    | 5MM      | 24CM   | 52224-149I | 52624-149A   | 52624-149B  | 52624-149C                                     |
|          |                                | 5MM      | 33CM   | 52255-149I | 52605-149A   | 52605-149B  | 52605-149C                                     |
|          |                                | 5MM      | 36CM   | 52236-149I | 52636-149A   | 52636-149B  | 52636-149C                                     |
| 30MM JAW | GLASSMAN<br>ATRAUMATIC GRAPER  | 5MM      | 45CM   | 52155-149I | 52615-149A   | 52615-149B  | 52615-149C                                     |
|          |                                | 5MM      | 24CM   | 52224-24I  | 52624-24A  | 52624-24B   | 52624-24C                                      |
|          |                                | 5MM      | 33CM   | 52255-24I  | 52605-24A  | 52605-24B   | 52605-24C                                      |
| 30MM JAW | GLASSMAN<br>ATRAUMATIC GRAPER  | 5MM      | 36CM   | 52236-24I  | 52636-24A  | 52636-24B   | 52636-24C                                      |
|          |                                | 5MM      | 45CM   | 52155-24I  | 52615-24A  | 52615-24B   | 52615-24C                                      |





# GRASPERS



MADE IN THE USA

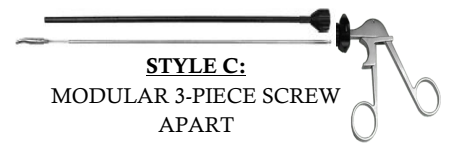
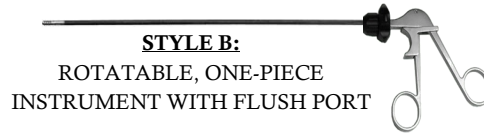
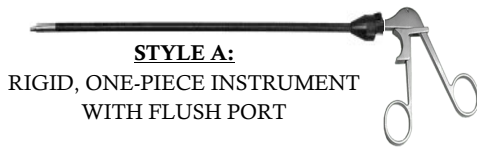

| TIP ID.  | DESCRIPTION  | DIAMETER | LENGTH | INSERT NO. | STYLE A:<br>RIGID, ONE-PIECE<br>INSTRUMENT<br>WITH FLUSH<br>PORT | STYLE B:<br>ROTATABLE,<br>ONE-PIECE<br>INSTRUMENT<br>WITH FLUSH<br>PORT | STYLE C:<br>MODULAR 3-<br>PIECE SCREW<br>APART |
|----------|--|----------|--------|------------|--|---|--|
| 16MM JAW | DBL. CUP FUNDUS<br>MAXI GRASPER                      | 5MM      | 24CM   | 52224-26I  | 52624-26A  | 52624-26B   | 52624-26C                                      |
|          |  | 5MM      | 33CM   | 52255-26I  | 52605-26A  | 52605-26B   | 52605-26C                                      |
|          |  | 5MM      | 36CM   | 52236-26I  | 52636-26A  | 52636-26B   | 52636-26C                                      |
|          |  | 5MM      | 45CM   | 52155-26I  | 52615-26A  | 52615-26B   | 52615-26C                                      |
| 16MM JAW | "WINER" STYLE<br>FUNDUS GRASPER                      | 5MM      | 24CM   | 52224-326I | 52624-326A   | 52624-326B  | 52624-326C                                     |
|          |  | 5MM      | 33CM   | 52255-326I | 52605-326A   | 52605-326B  | 52605-326C                                     |
|          |  | 5MM      | 36CM   | 52236-326I | 52636-326A   | 52636-326B  | 52636-326C                                     |
|          |  | 5MM      | 45CM   | 52155-326I | 52615-326A   | 52615-326B  | 52615-326C                                     |
| 16MM JAW | "MCKEARNAN"<br>STYLE FUNDUS<br>GRASPER               | 5MM      | 24CM   | 52224-126I | 52624-126A   | 52624-126B  | 52624-126C                                     |
|          |  | 5MM      | 33CM   | 52255-126I | 52605-126A   | 52605-126B  | 52605-126C                                     |
|          |  | 5MM      | 36CM   | 52236-126I | 52636-126A   | 52636-126B  | 52636-126C                                     |
|          |  | 5MM      | 45CM   | 52155-126I | 52615-126A   | 52615-126B  | 52615-126C                                     |
| 16MM JAW | FENESTRATED DBL.<br>FUNDUS GRASPER                   | 5MM      | 24CM   | 52224-226I | 52624-226A   | 52624-226B  | 52624-226C                                     |
|          |  | 5MM      | 33CM   | 52255-226I | 52605-226A   | 52605-226B  | 52605-226C                                     |
|          |  | 5MM      | 36CM   | 52236-226I | 52636-226A   | 52636-226B  | 52636-226C                                     |
|          |  | 5MM      | 45CM   | 52155-226I | 52615-226A   | 52615-226B  | 52615-226C                                     |
| 20MM JAW | ENDOCLINCH<br>FENESTRATED<br>GRASPER                 | 5MM      | 24CM   | 52224-27I  | 52624-27A  | 52624-27B   | 52624-27C                                      |
|          |  | 5MM      | 33CM   | 52255-27I  | 52605-27A  | 52605-27B   | 52605-27C                                      |
|          |  | 5MM      | 36CM   | 52236-27I  | 52636-27A  | 52636-27B   | 52636-27C                                      |
|          |  | 5MM      | 45CM   | 52155-27I  | 52615-27A  | 52615-27B   | 52615-27C                                      |
| 10MM JAW | ALLIGATOR GRASER,<br>RETRO-FACING<br>TEETH, 10MM JAW | 5MM      | 24CM   | 52224-29I  | 52624-29A  | 52624-29B   | 52624-29C                                      |
|          |  | 5MM      | 33CM   | 52255-29I  | 52605-29A  | 52605-29B   | 52605-29C                                      |
|          |  | 5MM      | 36CM   | 52236-29I  | 52636-29A  | 52636-29B   | 52636-29C                                      |
|          |  | 5MM      | 45CM   | 52155-29I  | 52615-29A  | 52615-29B   | 52615-29C                                      |
| 15MM JAW | ALLIGATOR GRASPER,<br>RETRO-FACING<br>TEETH          | 5MM      | 24CM   | 52224-129I | 52624-129A   | 52624-129B  | 52624-129C                                     |
|          |  | 5MM      | 33CM   | 52255-129I | 52605-129A   | 52605-129B  | 52605-129C                                     |
|          |  | 5MM      | 36CM   | 52236-129I | 52636-129A   | 52636-129B  | 52636-129C                                     |
|          |  | 5MM      | 45CM   | 52155-129I | 52615-129A   | 52615-129B  | 52615-129C                                     |
| 15MM JAW | GLASSMEN<br>ATRAUMATIC<br>GRASPER                    | 5MM      | 24CM   | 52224-30I  | 52624-30A  | 52624-30B   | 52624-30C                                      |
|          |  | 5MM      | 33CM   | 52255-30I  | 52605-30A  | 52605-30B   | 52605-30C                                      |
|          |  | 5MM      | 36CM   | 52236-30I  | 52636-30A  | 52636-30B   | 52636-30C                                      |
|          |  | 5MM      | 45CM   | 52155-30I  | 52615-30A  | 52615-30B   | 52615-30C                                      |











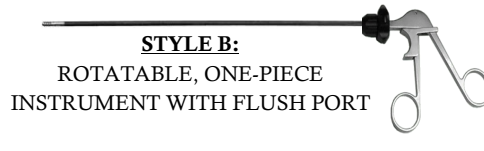
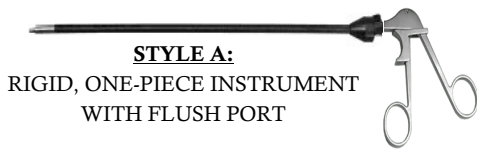

# GRASPERS



MADE IN THE USA



| TIP ID.  | DESCRIPTION  | DIAMETER | LENGTH | INSERT NO. | STYLE A:<br>RIGID, ONE-PIECE<br>INSTRUMENT<br>WITH FLUSH<br>PORT | STYLE B:<br>ROTATABLE,<br>ONE-PIECE<br>INSTRUMENT<br>WITH FLUSH<br>PORT | STYLE C:<br>MODULAR 3-<br>PIECE SCREW<br>APART |
|--|--|----------|--------|------------|--|---|--|
| <br>22MM JAW   | WAVE GRASPER, LONG<br>BEVELED EDGE, DA               | 5MM      | 24CM   | 52224-32I  | 52624-32A  | 52624-32B   | 52624-32C                                      |
|  |  | 5MM      | 33CM   | 52255-32I  | 52605-32A  | 52605-32B   | 52605-32C                                      |
|  |  | 5MM      | 36CM   | 52236-32I  | 52636-32A  | 52636-32B   | 52636-32C                                      |
|  |  | 5MM      | 45CM   | 52155-32I  | 52615-32A  | 52615-32B   | 52615-32C                                      |
| <br>22MM JAW   | WAVE GRASPER, LONG<br>BEVELED EDGE, SA               | 5MM      | 24CM   | 52224-33I  | 52624-33A  | 52624-33B   | 52624-33C                                      |
|  |  | 5MM      | 33CM   | 52255-33I  | 52605-33A  | 52605-33B   | 52605-33C                                      |
|  |  | 5MM      | 36CM   | 52236-33I  | 52636-33A  | 52636-33B   | 52636-33C                                      |
|  |  | 5MM      | 45CM   | 52155-33I  | 52615-33A  | 52615-33B   | 52615-33C                                      |
| <br>20MM JAW  | CLAW GRASPER, 2X3<br>TEETH, SA                       | 5MM      | 24CM   | 52224-36I  | 52624-36A  | 52624-36B   | 52624-36C                                      |
|  |  | 5MM      | 33CM   | 52255-36I  | 52605-36A  | 52605-36B   | 52605-36C                                      |
|  |  | 5MM      | 36CM   | 52236-36I  | 52636-36A  | 52636-36B   | 52636-36C                                      |
|  |  | 5MM      | 45CM   | 52155-36I  | 52615-36A  | 52615-36B   | 52615-36C                                      |
| <br>20MM JAW | CLAW GRASPER, 2X3<br>TEETH, W/ XTRA ROW<br>OF TEETH  | 5MM      | 24CM   | 52224-136I | 52624-136A   | 52624-136B  | 52624-136C                                     |
|  |  | 5MM      | 33CM   | 52255-136I | 52605-136A   | 52605-136B  | 52605-136C                                     |
|  |  | 5MM      | 36CM   | 52236-136I | 52636-136A   | 52636-136B  | 52636-136C                                     |
|  |  | 5MM      | 45CM   | 52155-136I | 52615-136A   | 52615-136B  | 52615-136C                                     |
| <br>20MM JAW | RETRACTION GRASPER,<br>2X3 TEETH, COBRA<br>STYLE, DA | 5MM      | 24CM   | 52224-34I  | 52624-34A  | 52624-34B   | 52624-34C                                      |
|  |  | 5MM      | 33CM   | 52255-34I  | 52605-34A  | 52605-34B   | 52605-34C                                      |
|  |  | 5MM      | 36CM   | 52236-34I  | 52636-34A  | 52636-34B   | 52636-34C                                      |
|  |  | 5MM      | 45CM   | 52155-34I  | 52615-34A  | 52615-34B   | 52615-34C                                      |
| <br>20MM JAW | RETRACTION GRASPER,<br>2X3 TEETH, COBRA<br>STYLE, SA | 5MM      | 24CM   | 52224-35I  | 52624-35A  | 52624-35B   | 52624-35C                                      |
|  |  | 5MM      | 33CM   | 52255-35I  | 52605-35A  | 52605-35B   | 52605-35C                                      |
|  |  | 5MM      | 36CM   | 52236-35I  | 52636-35A  | 52636-35B   | 52636-35C                                      |
|  |  | 5MM      | 45CM   | 52155-35I  | 52615-35A  | 52615-35B   | 52615-35C                                      |
| <br>20MM JAW | RETRACTION GRASPER,<br>2X3 TEETH, JARIT<br>STYLE, DA | 5MM      | 24CM   | 52224-134I | 52624-134A   | 52624-134B  | 52624-134C                                     |
|  |  | 5MM      | 33CM   | 52255-134I | 52605-134A   | 52605-134B  | 52605-134C                                     |
|  |  | 5MM      | 36CM   | 52236-134I | 52636-134A   | 52636-134B  | 52636-134C                                     |
|  |  | 5MM      | 45CM   | 52155-134I | 52615-134A   | 52615-134B  | 52615-134C                                     |
| <br>20MM JAW | RETRACTION GRASPER,<br>2X3 TEETH, JARIT<br>STYLE, SA | 5MM      | 24CM   | 52224-135I | 52624-135A   | 52624-135B  | 52624-135C                                     |
|  |  | 5MM      | 33CM   | 52255-135I | 52605-135A   | 52605-135B  | 52605-135C                                     |
|  |  | 5MM      | 36CM   | 52236-135I | 52636-135A   | 52636-135B  | 52636-135C                                     |
|  |  | 5MM      | 45CM   | 52155-135I | 52615-135A   | 52615-135B  | 52615-135C                                     |





# GRASPERS



MADE IN THE USA

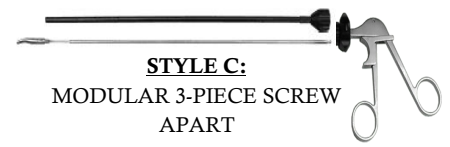
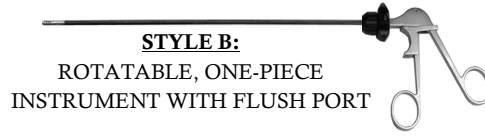
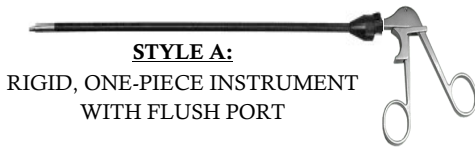

| TIP ID.  | DESCRIPTION                                   | DIAMETER | LENGTH | INSERT NO. | STYLE A:<br>RIGID, ONE-PIECE<br>INSTRUMENT<br>WITH FLUSH<br>PORT | STYLE B:<br>ROTATABLE,<br>ONE-PIECE<br>INSTRUMENT<br>WITH FLUSH<br>PORT | STYLE C:<br>MODULAR 3-<br>PIECE SCREW<br>APART |
|----------|---|----------|--------|------------|--|---|--|
| 16MM JAW | FENESTRATED GRASPER                           | 5MM      | 24CM   | 52224-38I  | 52624-38A  | 52624-38B   | 52624-38C                                      |
|          |   | 5MM      | 33CM   | 52255-38I  | 52605-38A  | 52605-38B   | 52605-38C                                      |
|          |   | 5MM      | 36CM   | 52236-38I  | 52636-38A  | 52636-38B   | 52636-38C                                      |
|          |   | 5MM      | 45CM   | 52155-38I  | 52615-38A  | 52615-38B   | 52615--38C                                     |
| 22MM JAW | FENESTRATED GRASPER                           | 5MM      | 24CM   | 52224-39I  | 52624-39A  | 52624-39B   | 52624-39C                                      |
|          |   | 5MM      | 33CM   | 52255-39I  | 52605-39A  | 52605-39B   | 52605-39C                                      |
|          |   | 5MM      | 36CM   | 52236-39I  | 52636-39A  | 52636-39B   | 52636-39C                                      |
|          |   | 5MM      | 45CM   | 52155-39I  | 52615-39A  | 52615-39B   | 52615-39C                                      |
| 40MM JAW | FENESTRATED GRASPER                           | 5MM      | 24CM   | 52224-40I  | 52624-40A  | 52624-40B   | 52624-40C                                      |
|          |   | 5MM      | 33CM   | 52255-40I  | 52605-40A  | 52605-40B   | 52605-40C                                      |
|          |   | 5MM      | 36CM   | 52236-40I  | 52636-40A  | 52636-40B   | 52636-40C                                      |
|          |   | 5MM      | 45CM   | 52155-40I  | 52615-40A  | 52615-40B   | 52615-40C                                      |
| 20MM JAW | JOHAN FENESTRATED GRASPER, 20MM TIP, SA       | 5MM      | 24CM   | 52224-41I  | 52624-41A  | 52624-41B   | 52624-41C                                      |
|          |   | 5MM      | 33CM   | 52255-41I  | 52605-41A  | 52605-41B   | 52605-41C                                      |
|          |   | 5MM      | 36CM   | 52236-41I  | 52636-41A  | 52636-41B   | 52636-41C                                      |
|          |   | 5MM      | 45CM   | 52155-41I  | 52615-41A  | 52615-41B   | 52615-41C                                      |
| 45MM JAW | JOHAN FENESTRATED GRASPER, 45MM TIP, SA       | 5MM      | 24CM   | 52224-42I  | 52624-42A  | 52624-42B   | 52624-42C                                      |
|          |   | 5MM      | 33CM   | 52255-42I  | 52605-42A  | 52605-42B   | 52605-42C                                      |
|          |   | 5MM      | 36CM   | 52236-42I  | 52636-42A  | 52636-42B   | 52636-42C                                      |
|          |   | 5MM      | 45CM   | 52155-42I  | 52615-42A  | 52615-42B   | 52615-42C                                      |
| 25MM JAW | DBL. FENESTRATED GRASPER                      | 5MM      | 24CM   | 52224-139I | 52624-139A   | 52624-139B  | 52624-139C                                     |
|          |   | 5MM      | 33CM   | 52255-139I | 52605-139A   | 52605-139B  | 52605-139C                                     |
|          |   | 5MM      | 36CM   | 52236-139I | 52636-139A   | 52636-139B  | 52636-139C                                     |
|          |   | 5MM      | 45CM   | 52155-139I | 52615-139A   | 52615-139B  | 52615-139C                                     |
| 25MM JAW | SCHROEDER TENACULUM, SINGLE TOOTH, ROUND TIP  | 5MM      | 24CM   | 52224-45I  | 52624-45A  | 52624-45B   | 52624-45C                                      |
|          |   | 5MM      | 33CM   | 52255-45I  | 52605-45A  | 52605-45B   | 52605-45C                                      |
|          |   | 5MM      | 36CM   | 52236-45I  | 52636-45A  | 52636-45B   | 52636-45C                                      |
|          |   | 5MM      | 45CM   | 52155-134I | 52615-134A   | 52615-134B  | 52615-134C                                     |
| 25MM JAW | SCHROEDER TENACULUM, SINGLE TOOTH, SQUARE TIP | 5MM      | 24CM   | 52224-145I | 52624-145A   | 52624-145B  | 52624-145C                                     |
|          |   | 5MM      | 33CM   | 52255-145I | 52605-145A   | 52605-145B  | 52605-145C                                     |
|          |   | 5MM      | 36CM   | 52236-145I | 52636-145A   | 52636-145B  | 52636-145C                                     |
|          |   | 5MM      | 45CM   | 52155-145I | 52615-145A   | 52615-145B  | 52615-145C                                     |









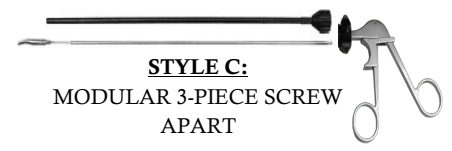
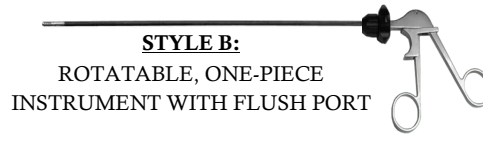
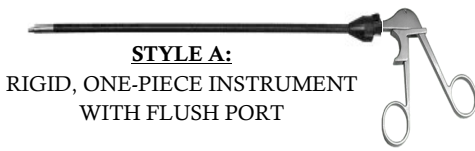

# GRASPERS

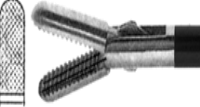

MADE IN THE USA



| TIP ID.  | DESCRIPTION  | DIAMETER | LENGTH | INSERT NO. | STYLE A:<br>RIGID, ONE-PIECE<br>INSTRUMENT<br>WITH FLUSH<br>PORT | STYLE B:<br>ROTATABLE,<br>ONE-PIECE<br>INSTRUMENT<br>WITH FLUSH<br>PORT | STYLE C:<br>MODULAR 3-<br>PIECE SCREW<br>APART |
|--|--|----------|--------|------------|--|---|--|
| <br>25MM JAW   | SCHROEDER<br>TENACULUM<br>GRASPER, SINGLE<br>TOOTH W/ EXTRA<br>GUIDE TOOTH | 5MM      | 24CM   | 52224-94I  | 52624-94A  | 52624-94B   | 52624-94C                                      |
|  |  | 5MM      | 33CM   | 52255-94I  | 52605-94A  | 52605-94B   | 52605-94C                                      |
|  |  | 5MM      | 36CM   | 52236-94I  | 52636-94A  | 52636-94B   | 52636-94C                                      |
|  |  | 5MM      | 45CM   | 52155-94I  | 52615-94A  | 52615-94B   | 52615-94C                                      |
| <br>15MM JAW | BULLET NOSE<br>GRASPER TC, MICRO<br>DIAMOND JAW<br>PATTERN                 | 5MM      | 24CM   | 52224-48I  | 52624-48A  | 52624-48B   | 52624-48C                                      |
|  |  | 5MM      | 33CM   | 52255-48I  | 52605-48A  | 52605-48B   | 52605-48C                                      |
|  |  | 5MM      | 36CM   | 52236-48I  | 52636-48A  | 52636-48B   | 52636-48C                                      |
|  |  | 5MM      | 45CM   | 52155-48I  | 52615-48A  | 52615-48B   | 52615-48C                                      |
| <br>15MM JAW | BULLET NOSE<br>GRASPER TC, CROSS<br>DIAMOND JAW<br>PATTERN                 | 5MM      | 24CM   | 52224-49I  | 52624-49A  | 52624-49B   | 52624-49C                                      |
|  |  | 5MM      | 33CM   | 52255-49I  | 52605-49A  | 52605-49B   | 52605-49C                                      |
|  |  | 5MM      | 36CM   | 52236-49I  | 52636-49A  | 52636-49B   | 52636-49C                                      |
|  |  | 5MM      | 45CM   | 52155-49I  | 52615-49A  | 52615-49B   | 52615-49C                                      |
| <br>15MM JAW | "DAVOL" TYPE,<br>GRASPER, SCOOPED-<br>OUT JAW & GENTLY<br>MASHING TEETH    | 5MM      | 24CM   | 52224-90I  | 52624-90A  | 52624-90B   | 52624-90C                                      |
|  |  | 5MM      | 33CM   | 52255-90I  | 52605-90A  | 52605-90B   | 52605-90C                                      |
|  |  | 5MM      | 36CM   | 52236-90I  | 52636-90A  | 52636-90B   | 52636-90C                                      |
|  |  | 5MM      | 45CM   | 52155-90I  | 52615-90A  | 52615-90B   | 52615-90C                                      |
| <br>20MM JAW | "ACCESS" TYPE,<br>FENESTRATED<br>GRASPER                                   | 5MM      | 24CM   | 52224-42I  | 52624-42A  | 52624-42B   | 52624-42C                                      |
|  |  | 5MM      | 33CM   | 52255-42I  | 52605-42A  | 52605-42B   | 52605-42C                                      |
|  |  | 5MM      | 36CM   | 52236-42I  | 52636-42A  | 52636-42B   | 52636-42C                                      |
|  |  | 5MM      | 45CM   | 52155-42I  | 52615-42A  | 52615-42B   | 52615-42C                                      |





*D*ISPOSABLE &  
*R*EPOSABLE  
*S*ERIES

**ELMED** IS ONE OF THE LEADERS OF BRINGING OPTIONS TO ALL THAT WANT THEM.

WITH THAT IN MIND, WE BRING YOU THE ELMED DISPOSABLE & REPOSABLE LAP SERIES. SINGLE USE TIPS FOR THOSE WHO WANT TRUE DISPOSABLE INSTRUMENTATION AND REPOSABLE TIPS FOR THOSE WHO WANT TO WATCH THEIR SPENDING.











# ELMED REPOSABLE HANDLE & SHAFT W/ DISPOSABLE TIPS



MADE IN THE USA



| HANDLE STYLE   | ITEM NO.        | DESCRIPTION  |
|--|-----------------|--|
|   | <b>52601-05</b> | 5MM, 33CM, ROTATABLE, INSULATED, NON-RATCHET HANDLE & SHAFT FOR USE WITH ELMED DISPOSABLE TIPS               |
|  | <b>52601-06</b> | 5MM, 45CM, ROTATABLE, INSULATED, NON-RATCHET HANDLE & SHAFT FOR USE WITH ELMED DISPOSABLE TIPS               |
|  | <b>52601-07</b> | 5MM, 33CM, ROTATABLE, INSULATED,, ON DEMAND ON/OFF RATCHET HANDLE & SHAFT FOR USE WITH ELMED DISPOSABLE TIPS |
|  | <b>52601-08</b> | 5MM, 45CM, ROTATABLE, INSULATED,, ON DEMAND ON/OFF RATCHET HANDLE & SHAFT FOR USE WITH ELMED DISPOSABLE TIPS |

| TIP STYLE   | ITEM NO.        | DESCRIPTION  |
|---|-----------------|--|
|  | <b>52600-01</b> | TIP ONLY DISPOSABLE CURVED MINI METZENBAUM TIPS - STERILE (10 PKG) FOR 52601-05 + 52601-06 + 52601-07 + 52601-08 HANDLE      |
|  | <b>52600-02</b> | TIP ONLY DISPOSABLE CURVED METZENBAUM TIPS - STERILE (10 PKG) FOR 52601-05 + 52601-06 + 52601-07 + 52601-08 HANDLE           |
|  | <b>52600-03</b> | TIP ONLY DISPOSABLE MARYLAND TIPS - STERILE (10 PKG) FOR 52601-05 + 52601-06 + 52601-07 + 52601-08 HANDLE                    |
|  | <b>52600-04</b> | TIP ONLY DISPOSABLE FENESTRATED GRASPER, SHORT, TIPS - STERILE (10 PKG) FOR 52601-05 + 52601-06 + 52601-07 + 52601-08 HANDLE |
|  | <b>52600-05</b> | TIP ONLY DISPOSABLE ENDO CLINCH GRASPER TIPS - STERILE (10 PKG) FOR 52601-05 + 52601-06 + 52601-07 + 52601-08 HANDLE         |
|  | <b>52600-06</b> | TIP ONLY DISPOSABLE FENESTRATED GRASPER, LONG, TIPS - STERILE (10 PKG) FOR 52601-05 + 52601-06 + 52601-07 + 52601-08 HANDLE  |





# ELMED REPOSABLE HANDLE & SHAFT W/ REPOSABLE TIPS



MADE IN THE USA









| ITEM NO.        | DESCRIPTION                               |
|-----------------|---|
| <b>52601-09</b> | PEEK HANDLE, NON-RATCHET W/ RF-CONNECTION |



| ITEM NO.        | DESCRIPTION  |
|-----------------|--|
| <b>52601-10</b> | 5MM, 33CM, INSULATED SHAFT FOR USE WITH ELMED REPOSABLE TIPS |
| <b>52601-11</b> | 5MM, 45CM, INSULATED SHAFT FOR USE WITH ELMED REPOSABLE TIPS |



| ITEM NO.        | DESCRIPTION                                 |
|-----------------|---|
| <b>52601-12</b> | 5MM, 33CM, CONNECTION ROD W/ EASY SNAP LOCK |
| <b>52601-13</b> | 5MM, 45CM, CONNECTION ROD W/ EASY SNAP LOCK |

| TIP STYLE   | ITEM NO.        | DESCRIPTION   |
|---|-----------------|---|
|  | <b>52600-07</b> | TIP ONLY REPOSABLE SMALL CURVED METZENBAUM TIPS - NON-STERILE (10 PKG)    |
|  | <b>52600-08</b> | TIP ONLY REPOSABLE MEDIUM CURVED METZENBAUM TIPS - NON-STERILE (10 PKG)   |
|  | <b>52600-09</b> | TIP ONLY REPOSABLE LARGE CURVED METZENBAUM TIPS - NON-STERILE (10 PKG)    |
|  | <b>52600-11</b> | TIP ONLY REPOSABLE MEDIUM STRAIGHT METZENBAUM TIPS - NON-STERILE (10 PKG) |
|  | <b>52600-12</b> | TIP ONLY REPOSABLE LARGE STRAIGHT METZENBAUM TIPS - NON-STERILE (10 PKG)  |
|  | <b>52600-13</b> | TIP ONLY REPOSABLE MARYLAND TIP - NON-STERILE (10 PKG)                    |
|  | <b>52600-14</b> | TIP ONLY REPOSABLE ENDO CLINCH GRASPER TIPS - NON-STERILE (10 PKG)        |





# TRADITIONAL SERIES

**ELMED** IS ONE OF THE LEADERS AND PIONEERS IN THE FIELD OF  
LAPAROSCOPIC INSTRUMENTS AND RELATED EQUIPMENT.













OUR INSTRUMENTS HAVE BEEN DEVELOPED IN CLOSE COOPERATION WITH  
LEADING SURGEONS. THEY ARE COMPLETELY REUSABLE,  
UNCOMPROMISING IN QUALITY AND DURABILITY, YET SIMPLE IN  
OPERATION AND MAINTENANCE.



# TRADITIONAL 5MM LAPAROSCOPIC INSTRUMENTS



MADE IN THE USA

| TIP ID.  | DESCRIPTION                 | DIAMETER | LENGTH | STANDARD                  | SPRING                    | RATCHET                   |
|--|-----------------------------|----------|--------|---------------------------|---------------------------|---------------------------|
|    | HOOK SCISSORS               | 5MM      | 33CM   | <a href="#">52502-01A</a> | <a href="#">52502-01B</a> | <a href="#">52502-01C</a> |
|  |                             | 5MM      | 36CM   | <a href="#">52503-01A</a> | <a href="#">52503-01B</a> | <a href="#">52503-01C</a> |
|  |                             | 5MM      | 45CM   | <a href="#">52501-01A</a> | <a href="#">52501-01B</a> | <a href="#">52501-01C</a> |
|    | PERITONEAL SCISSORS         | 5MM      | 33CM   | <a href="#">52502-02A</a> | <a href="#">52502-02B</a> | <a href="#">52502-02C</a> |
|  |                             | 5MM      | 36CM   | <a href="#">52503-02A</a> | <a href="#">52503-02B</a> | <a href="#">52503-02C</a> |
|  |                             | 5MM      | 45CM   | <a href="#">52501-02A</a> | <a href="#">52501-02B</a> | <a href="#">52501-02C</a> |
|    | SERRATED SCISSORS           | 5MM      | 33CM   | <a href="#">52502-03A</a> | <a href="#">52502-03B</a> | <a href="#">52502-03C</a> |
|  |                             | 5MM      | 36CM   | <a href="#">52503-03A</a> | <a href="#">52503-03B</a> | <a href="#">52503-03C</a> |
|  |                             | 5MM      | 45CM   | <a href="#">52501-03A</a> | <a href="#">52501-03B</a> | <a href="#">52501-03C</a> |
|    | METZENBAUM SCISSORS, CURVED | 5MM      | 33CM   | <a href="#">52502-04A</a> | <a href="#">52502-04B</a> | <a href="#">52502-04C</a> |
|  |                             | 5MM      | 36CM   | <a href="#">52503-04A</a> | <a href="#">52503-04B</a> | <a href="#">52503-04C</a> |
|  |                             | 5MM      | 45CM   | <a href="#">52501-04A</a> | <a href="#">52501-04B</a> | <a href="#">52501-04C</a> |
|  | POINTED SPOON FORCEPS       | 5MM      | 33CM   | <a href="#">52502-05A</a> | <a href="#">52502-05B</a> | <a href="#">52502-05C</a> |
|  |                             | 5MM      | 36CM   | <a href="#">52503-05A</a> | <a href="#">52503-05B</a> | <a href="#">52503-05C</a> |
|  |                             | 5MM      | 45CM   | <a href="#">52501-05A</a> | <a href="#">52501-05B</a> | <a href="#">52501-05C</a> |
|  | SPOON FORCEPS               | 5MM      | 33CM   | <a href="#">52502-06A</a> | <a href="#">52502-06B</a> | <a href="#">52502-06C</a> |
|  |                             | 5MM      | 36CM   | <a href="#">52503-06A</a> | <a href="#">52503-06B</a> | <a href="#">52503-06C</a> |
|  |                             | 5MM      | 45CM   | <a href="#">52501-06A</a> | <a href="#">52501-06B</a> | <a href="#">52501-06C</a> |
|  | SPOON FORCEPS W/ TEETH      | 5MM      | 33CM   | <a href="#">52502-07A</a> | <a href="#">52502-07B</a> | <a href="#">52502-07C</a> |
|  |                             | 5MM      | 36CM   | <a href="#">52503-07A</a> | <a href="#">52503-07B</a> | <a href="#">52503-07C</a> |
|  |                             | 5MM      | 45CM   | <a href="#">52501-07A</a> | <a href="#">52501-07B</a> | <a href="#">52501-07C</a> |
|  | DA SPOON FORCEPS            | 5MM      | 33CM   | <a href="#">52502-08A</a> | <a href="#">52502-08B</a> | <a href="#">52502-08C</a> |
|  |                             | 5MM      | 36CM   | <a href="#">52503-08A</a> | <a href="#">52503-08B</a> | <a href="#">52503-08C</a> |
|  |                             | 5MM      | 45CM   | <a href="#">52501-08A</a> | <a href="#">52501-08B</a> | <a href="#">52501-08C</a> |
|  | DA SPOON FORCEPS W/ TEETH   | 5MM      | 33CM   | <a href="#">52502-09A</a> | <a href="#">52502-09B</a> | <a href="#">52502-09C</a> |
|  |                             | 5MM      | 36CM   | <a href="#">52503-09A</a> | <a href="#">52503-09B</a> | <a href="#">52503-09C</a> |
|  |                             | 5MM      | 45CM   | <a href="#">52501-09A</a> | <a href="#">52501-09B</a> | <a href="#">52501-09C</a> |
|  | BIOPSY PUNCH FORCEPS        | 5MM      | 33CM   | <a href="#">52502-10A</a> | <a href="#">52502-10B</a> | <a href="#">52502-10C</a> |
|  |                             | 5MM      | 36CM   | <a href="#">52503-10A</a> | <a href="#">52503-10B</a> | <a href="#">52503-10C</a> |
|  |                             | 5MM      | 45CM   | <a href="#">52501-10A</a> | <a href="#">52501-10B</a> | <a href="#">52501-10C</a> |
|  | BIOPSY PUNCH W/ TEETH       | 5MM      | 33CM   | <a href="#">52502-11A</a> | <a href="#">52502-11B</a> | <a href="#">52502-11C</a> |
|  |                             | 5MM      | 36CM   | <a href="#">52503-11A</a> | <a href="#">52503-11B</a> | <a href="#">52503-11C</a> |
|  |                             | 5MM      | 45CM   | <a href="#">52501-11A</a> | <a href="#">52501-11B</a> | <a href="#">52501-11C</a> |
|  | HOOK PUNCH                  | 5MM      | 33CM   | <a href="#">52502-12A</a> | <a href="#">52502-12B</a> | <a href="#">52502-12C</a> |
|  |                             | 5MM      | 36CM   | <a href="#">52503-12A</a> | <a href="#">52503-12B</a> | <a href="#">52503-12C</a> |
|  |                             | 5MM      | 45CM   | <a href="#">52501-12A</a> | <a href="#">52501-12B</a> | <a href="#">52501-12C</a> |















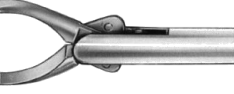

# TRADITIONAL 5MM LAPAROSCOPIC INSTRUMENTS



MADE IN THE USA

| TIP ID.  | DESCRIPTION                               | DIAMETER | LENGTH | <br>STANDARD | <br>SPRING | <br>RATCHET |
|--|---|----------|--------|--|---|--|
|    | STANDARD GRASPER W/ SPOON                 | 5MM      | 33CM   | 52502-13A  | 52502-13B   | 52502-13C  |
|  |   | 5MM      | 36CM   | 52503-13A  | 52503-13B   | 52503-13C  |
|  |   | 5MM      | 45CM   | 52501-13A  | 52501-13B   | 52501-13C  |
|    | POINTED GRASPER W/ SPOON                  | 5MM      | 33CM   | 52502-14A  | 52502-14B   | 52502-14C  |
|  |   | 5MM      | 36CM   | 52503-14A  | 52503-14B   | 52503-14C  |
|  |   | 5MM      | 45CM   | 52501-14A  | 52501-14B   | 52501-14C  |
|    | STANDARD GRASPER                          | 5MM      | 33CM   | 52502-15A  | 52502-15B   | 52502-15C  |
|  |   | 5MM      | 36CM   | 52503-15A  | 52503-15B   | 52503-15C  |
|  |   | 5MM      | 45CM   | 52501-15A  | 52501-15B   | 52501-15C  |
|    | BACKBITING GRASPER                        | 5MM      | 33CM   | 52502-16A  | 52502-16B   | 52502-16C  |
|  |   | 5MM      | 36CM   | 52503-16A  | 52503-16B   | 52503-16C  |
|  |   | 5MM      | 45CM   | 52501-16A  | 52501-16B   | 52501-16C  |
|  | ATRAUMATIC GRASPER                        | 5MM      | 33CM   | 52502-17A  | 52502-17B   | 52502-17C  |
|  |   | 5MM      | 36CM   | 52503-17A  | 52503-17B   | 52503-17C  |
|  |   | 5MM      | 45CM   | 52501-17A  | 52501-17B   | 52501-17C  |
|  | CLAW GRASPER                              | 5MM      | 33CM   | 52502-18A  | 52502-18B   | 52502-18C  |
|  |   | 5MM      | 36CM   | 52503-18A  | 52503-18B   | 52503-18C  |
|  |   | 5MM      | 45CM   | 52501-18A  | 52501-18B   | 52501-18C  |
|  | PETELIN DISSECTOR 60°                     | 5MM      | 33CM   | 52502-19A  | 52502-19B   | 52502-19C  |
|  |   | 5MM      | 36CM   | 52503-19A  | 52503-19B   | 52503-19C  |
|  |   | 5MM      | 45CM   | 52501-19A  | 52501-19B   | 52501-19C  |
|  | PETELIN DISSECTOR 30°                     | 5MM      | 33CM   | 52502-20A  | 52502-20B   | 52502-20C  |
|  |   | 5MM      | 36CM   | 52503-20A  | 52503-20B   | 52503-20C  |
|  |   | 5MM      | 45CM   | 52501-20A  | 52501-20B   | 52501-20C  |
|  | STRONG RIGHT ANGLE DISSECTOR              | 5MM      | 33CM   | 52502-31A  | 52502-31B   | 52502-31C  |
|  |   | 5MM      | 36CM   | 52503-31A  | 52503-31B   | 52503-31C  |
|  |   | 5MM      | 45CM   | 52501-31A  | 52501-31B   | 52501-31C  |
|  | SPOON FORCEPS W/ TEETH                    | 5MM      | 33CM   | 52502-32A  | 52502-32B   | 52502-32C  |
|  |   | 5MM      | 36CM   | 52503-32A  | 52503-32B   | 52503-32C  |
|  |   | 5MM      | 45CM   | 52501-32A  | 52501-32B   | 52501-32C  |
|  | SCHROEDER TENACULUM GRASPER, SINGLE TOOTH | 5MM      | 33CM   | 52502-33A  | 52502-33B   | 52502-33C  |
|  |   | 5MM      | 36CM   | 52503-33A  | 52503-33B   | 52503-33C  |
|  |   | 5MM      | 45CM   | 52501-33A  | 52501-33B   | 52501-33C  |





# TRADITIONAL 5MM LAPAROSCOPIC INSTRUMENTS



MADE IN THE USA



ALL STAINLESS STEEL CONSTRUCTION W/  
MICRO TIPS & STANDARD HANDLE



CURVED  
MICRO  
SCISSORS

|      |                          |
|------|--------------------------|
| 33CM | <a href="#">52502-21</a> |
| 45CM | <a href="#">52501-21</a> |



STRAIGHT  
MICRO  
SCISSORS

|      |                          |
|------|--------------------------|
| 33CM | <a href="#">52502-22</a> |
| 45CM | <a href="#">52501-22</a> |



MICRO  
GRASPER

|      |                          |
|------|--------------------------|
| 33CM | <a href="#">52502-23</a> |
| 45CM | <a href="#">52501-23</a> |



DA MICRO  
GRASPER

|      |                          |
|------|--------------------------|
| 33CM | <a href="#">52502-24</a> |
| 45CM | <a href="#">52501-24</a> |



MICRO-  
BIOPSY  
PUNCH

|      |                          |
|------|--------------------------|
| 33CM | <a href="#">52502-25</a> |
| 45CM | <a href="#">52501-25</a> |

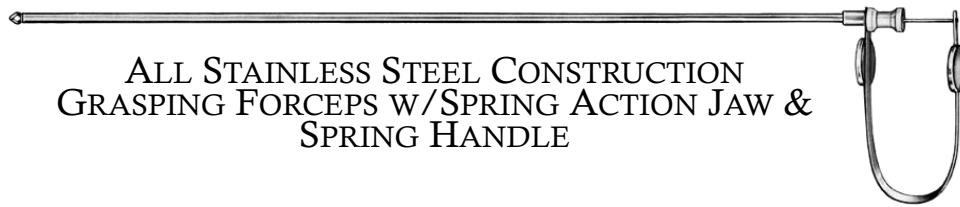

ALL STAINLESS STEEL CONSTRUCTION  
GRASPING FORCEPS W/SPRING ACTION JAW &  
SPRING HANDLE

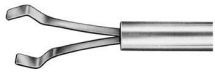

STD.  
GRASPER

|      |                          |
|------|--------------------------|
| 33CM | <a href="#">52502-50</a> |
| 45CM | <a href="#">52501-50</a> |



ATRAUMATIC  
GRASPER

|      |                          |
|------|--------------------------|
| 33CM | <a href="#">52502-51</a> |
| 45CM | <a href="#">52501-51</a> |



ATRAUMATIC  
GRASPER W/  
STRONG JAW

|      |                          |
|------|--------------------------|
| 33CM | <a href="#">52502-52</a> |
| 45CM | <a href="#">52501-52</a> |



ROUND  
BOWEL  
GRASPER

|      |                          |
|------|--------------------------|
| 33CM | <a href="#">52502-53</a> |
| 45CM | <a href="#">52501-53</a> |



"T" BOWEL  
GRASPER

|      |                          |
|------|--------------------------|
| 33CM | <a href="#">52502-54</a> |
| 45CM | <a href="#">52501-54</a> |



CYST  
GRASPER

|      |                          |
|------|--------------------------|
| 33CM | <a href="#">52502-55</a> |
| 45CM | <a href="#">52501-55</a> |



TUBAL  
GRASPER

|      |                          |
|------|--------------------------|
| 33CM | <a href="#">52502-56</a> |
| 45CM | <a href="#">52501-56</a> |



FENESTRATED  
GRASPER

|      |                          |
|------|--------------------------|
| 33CM | <a href="#">52502-57</a> |
| 45CM | <a href="#">52501-57</a> |



















# TRADITIONAL 10MM LAPAROSCOPIC INSTRUMENTS



MADE IN THE USA

| TIP ID.  | DESCRIPTION        | DIAMETER | LENGTH | STANDARD<br> | SPRING<br> | RATCHET<br> |
|--|--------------------|----------|--------|--|---|--|
|    | STRAIGHT SCISSORS  | 10MM     | 33CM   | 52112-01A  | 52112-01B   | 52112-01C  |
|  |                    | 10MM     | 36CM   | 52113-01A  | 52113-01B   | 52113-01C  |
|  |                    | 10MM     | 45CM   | 52111-01A  | 52111-01B   | 52111-01C  |
|    | SPOON FORCEPS      | 10MM     | 33CM   | 52112-02A  | 52112-02B   | 52112-02C  |
|  |                    | 10MM     | 36CM   | 52113-02A  | 52113-02B   | 52113-02C  |
|  |                    | 10MM     | 45CM   | 52111-02A  | 52111-02B   | 52111-02C  |
|    | CLAW FORCEPS       | 10MM     | 33CM   | 52112-03A  | 52112-03B   | 52112-03C  |
|  |                    | 10MM     | 36CM   | 52113-03A  | 52113-03B   | 52113-03C  |
|  |                    | 10MM     | 45CM   | 52111-03A  | 52111-03B   | 52111-03C  |
|    | GRASPING FORCEPS   | 10MM     | 33CM   | 52112-04A  | 52112-04B   | 52112-04C  |
|  |                    | 10MM     | 36CM   | 52113-04A  | 52113-04B   | 52113-04C  |
|  |                    | 10MM     | 45CM   | 52111-04A  | 52111-04B   | 52111-04C  |
|   | DEBAKEY FORCEPS    | 10MM     | 33CM   | 52112-05A  | 52112-05B   | 52112-05C  |
|  |                    | 10MM     | 36CM   | 52113-05A  | 52113-05B   | 52113-05C  |
|  |                    | 10MM     | 45CM   | 52111-05A  | 52111-05B   | 52111-05C  |
|  | BABCOCK FORCEPS    | 10MM     | 33CM   | 52112-07A  | 52112-07B   | 52112-07C  |
|  |                    | 10MM     | 36CM   | 52113-07A  | 52113-07B   | 52113-07C  |
|  |                    | 10MM     | 45CM   | 52111-07A  | 52111-07B   | 52111-07C  |
|  | ALLIS FORCEPS      | 10MM     | 33CM   | 52112-08A  | 52112-08B   | 52112-08C  |
|  |                    | 10MM     | 36CM   | 52113-08A  | 52113-08B   | 52113-08C  |
|  |                    | 10MM     | 45CM   | 52111-08A  | 52111-08B   | 52111-08C  |
|  | MARYLAND FORCEPS   | 10MM     | 33CM   | 52112-09A  | 52112-09B   | 52112-09C  |
|  |                    | 10MM     | 36CM   | 52113-09A  | 52113-09B   | 52113-09C  |
|  |                    | 10MM     | 45CM   | 52111-09A  | 52111-09B   | 52111-09C  |
|  | MIXTER FORCEPS 90° | 10MM     | 33CM   | 52112-10A  | 52112-10B   | 52112-10C  |
|  |                    | 10MM     | 36CM   | 52113-10A  | 52113-10B   | 52113-10C  |
|  |                    | 10MM     | 45CM   | 52111-10A  | 52111-10B   | 52111-10C  |
|  | DUVAL FORCEPS      | 10MM     | 33CM   | 52112-11A  | 52112-11B   | 52112-11C  |
|  |                    | 10MM     | 36CM   | 52113-11A  | 52113-11B   | 52113-11C  |
|  |                    | 10MM     | 45CM   | 52111-11A  | 52111-11B   | 52111-11C  |
|  | TENACULUM FORCEPS  | 10MM     | 33CM   | 52112-15A  | 52112-15B   | 52112-15C  |
|  |                    | 10MM     | 36CM   | 52113-15A  | 52113-15B   | 52113-15C  |
|  |                    | 10MM     | 45CM   | 52111-15A  | 52111-15B   | 52111-15C  |
|  | GLASSMAN FORCEPS   | 10MM     | 33CM   | 52112-16A  | 52112-16B   | 52112-16C  |
|  |                    | 10MM     | 36CM   | 52113-16A  | 52113-16B   | 52113-16C  |
|  |                    | 10MM     | 45CM   | 52111-16A  | 52111-16B   | 52111-16C  |



# SUTURE & LIGATURE INSTRUMENTS

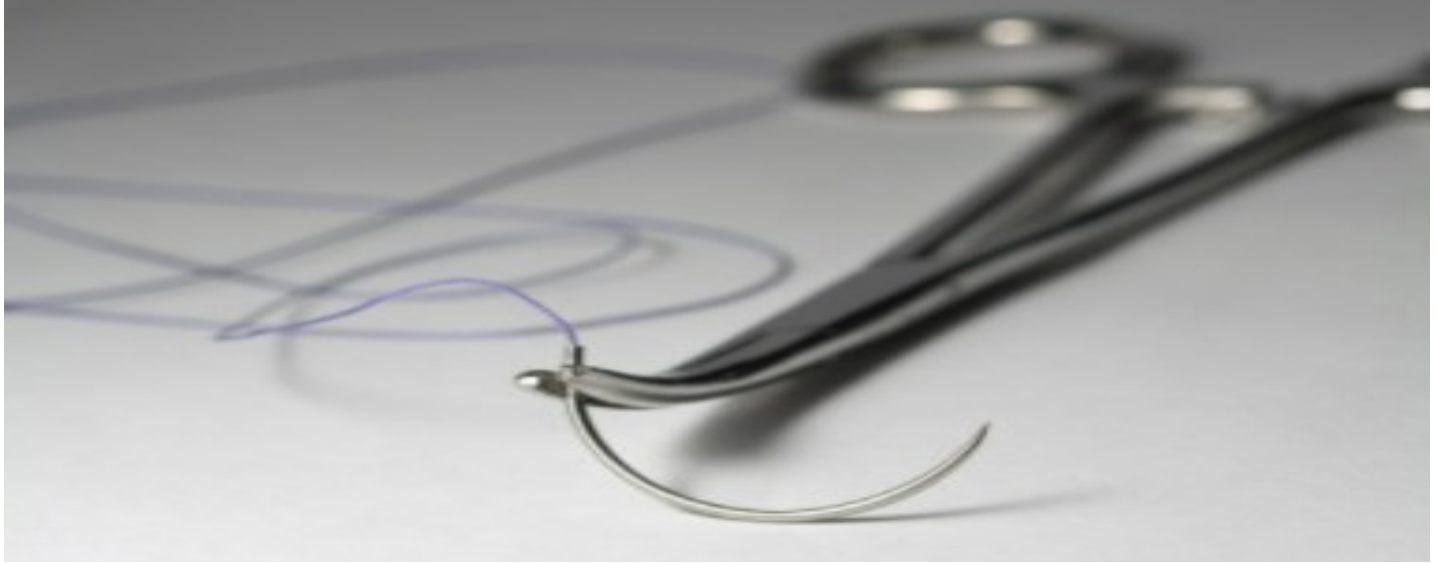

*ELMED LAPAROSCOPIC NEEDLE HOLDERS*, OUR PRECISION ENGINEERED NEEDLE HOLDERS, GIVE THE FEELING OF “OPEN SURGICAL PROCEDURE.” THEY ARE DESIGNED WITH HANDLES THAT MINIMIZE HAND FATIGUE, MAXIMIZE HOLDING POWER AND ALLOW A NATURAL ROTATION OF THE WRIST.

*ELMED CLIP APPLIERS* ARE 5MM DIAMETER AND 10MM DIAMETER REUSABLE, SINGLE-ACTION CLIP APPLIERS FOR LAPAROSCOPIC SURGERY PROCEDURES.



# ELMED LAPAROSCOPIC 5MM CLIP APPLIERS



MADE IN THE USA

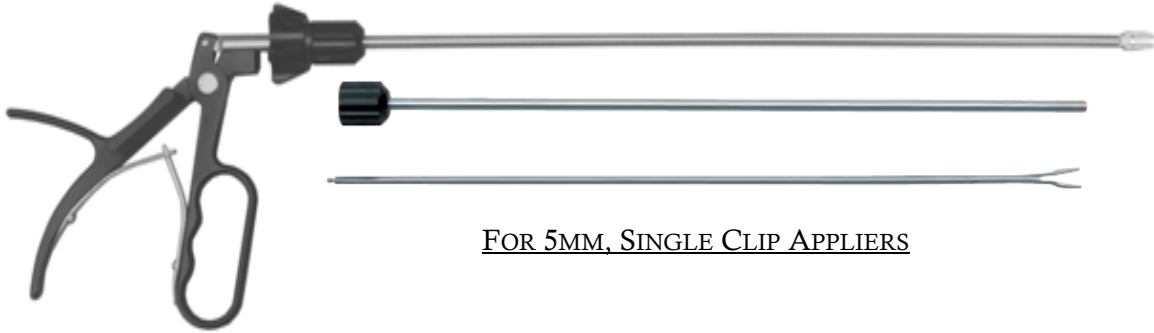

FOR 5MM, SINGLE CLIP APPLIERS

## FEATURES FOR 5 CLIP APPLIERS:

- MODULAR, 3-PIECE SCREW-APART INSTRUMENT FOR SIMPLE CLEANING & MAINTENANCE
- CONSTRUCTED OF THE HIGHEST GRADE STAINLESS STEEL
- DURABLE, NON-DEFORMING JAW FOR CONSISTENT CLIP APPLICATION

## FOR USE WITH THE FOLLOWING

### CLIPS:

- ETHICON
- WECK
- PILLING
- HORIZON

| ITEM NO.         | DESCRIPTION  |
|------------------|--|
| <b>52533-01C</b> | 5MM, 33CM, LAP CLIP APPLICATOR, ETHICON SMALL, ROTATABLE, 3-PIECE DETACHABLE   |
| <b>52533-02C</b> | 5MM, 33CM, LAP CLIP APPLICATOR, ETHICON MEDIUM, ROTATABLE, 3-PIECE DETACHABLE  |
| <b>52533-11C</b> | 5MM, 33CM, LAP CLIP APPLICATOR, WECK SMALL, ROTATABLE, 3-PIECE DETACHABLE  |
| <b>52533-12C</b> | 5MM, 33CM, LAP CLIP APPLICATOR, WECK MEDIUM, ROTATABLE, 3-PIECE DETACHABLE   |
| <b>52545-01C</b> | 5MM, 45CM LAP CLIP APPLIER FOR SMALL ETHICON CLIPS, 3-PIECE TAKE APART (FOR USE W/ 5.5MM SHEATH)                     |
| <b>52545-02C</b> | 5MM, 45CM LAP CLIP APPLIER FOR MEDIUM ETHICON CLIPS, 3-PIECE TAKE APART (FOR USE W/ 6MM SHEATH)                      |
| <b>52545-11C</b> | 5MM, 45CM LAP CLIP APPLIER FOR SMALL ELMED/PILLING WECK TITANIUM CLIPS, 3-PIECE TAKE APART (FOR USE W/ 5.5MM SHEATH) |
| <b>52545-12C</b> | 5MM, 45CM LAP CLIP APPLIER FOR MEDIUM ELMED/PILLING WECK TITANIUM CLIPS, 3-PIECE TAKE APART (FOR USE W/ 6MM SHEATH)  |





# ELMED LAPAROSCOPIC 10MM CLIP APPLIERS



MADE IN THE USA

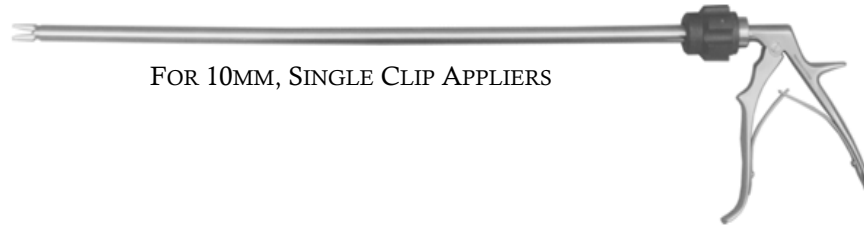

FOR 10MM, SINGLE CLIP APPLIERS

## ETHICON ONE-PIECE STYLE

| ITEM NO. | DESCRIPTION  |
|----------|--|
| 52133-01 | 10MM, 33CM, LAP CLIP APPLICATOR, ETHICON SMALL, ROTATABLE, ONE-PIECE W/ FLUSHPORT        |
| 52133-02 | 10MM, 33CM, LAP CLIP APPLICATOR, ETHICON MEDIUM, ROTATABLE, ONE-PIECE W/ FLUSHPORT       |
| 52133-03 | 10MM, 33CM, LAP CLIP APPLICATOR, ETHICON MEDIUM-LARGE, ROTATABLE, ONE-PIECE W/ FLUSHPORT |
| 52133-04 | 10MM, 33CM, LAP CLIP APPLICATOR, ETHICON, LARGE, ROTATABLE, ONE-PIECE W/ FLUSHPORT       |

## HORIZON ONE-PIECE STYLE

| ITEM NO. | DESCRIPTION   |
|----------|---|
| 52133-41 | 10MM, 33CM, LAP CLIP APPLICATOR, HORIZON, SMALL, ROTATABLE, ONE-PIECE W/ FLUSHPORT        |
| 52133-42 | 10MM, 33CM, LAP CLIP APPLICATOR, HORIZON, MEDIUM, ROTATABLE, ONE-PIECE W/ FLUSHPORT       |
| 52133-43 | 10MM, 33CM, LAP CLIP APPLICATOR, HORIZON, MEDIUM-LARGE, ROTATABLE, ONE-PIECE W/ FLUSHPORT |
| 52133-44 | 10MM, 33CM, LAP CLIP APPLICATOR, HORIZON, LARGE, ROTATABLE, ONE-PIECE W/ FLUSHPORT        |

## WECK ONE-PIECE STYLE

| ITEM NO. | DESCRIPTION   |
|----------|---|
| 52133-21 | 10MM, 33CM, LAP CLIP APPLICATOR, WECK SMALL, ROTATABLE, ONE-PIECE W/ FLUSHPORT        |
| 52133-22 | 10MM, 33CM, LAP CLIP APPLICATOR, WECK, MEDIUM, ROTATABLE, ONE-PIECE W/ FLUSHPORT      |
| 52133-23 | 10MM, 33CM, LAP CLIP APPLICATOR, WECK MEDIUM-LARGE, ROTATABLE, ONE-PIECE W/ FLUSHPORT |

## 3-PIECE MODULAR STYLE

| ITEM NO.  | DIA. | LENGTH | DESCRIPTION   | INSERT ONLY | HANDLE ONLY | SHAFT ONLY |
|-----------|------|--------|---|-------------|-------------|------------|
| 52133-01C | 10MM | 33CM   | LAP CLIP APPLICATOR, ETHICON SMALL, ROTATABLE         | 52133-01I   | 52555-01    | 52133-00   |
| 52133-02C | 10MM | 33CM   | LAP CLIP APPLICATOR, ETHICON MEDIUM, ROTATABLE        | 52133-02I   | 52555-01    | 52133-00   |
| 52133-03C | 10MM | 33CM   | LAP CLIP APPLICATOR, ETHICON MEDIUM-LARGE, ROTATABLE  | 52133-03I   | 52555-01    | 52133-00   |
| 52133-04C | 10MM | 33CM   | LAP CLIP APPLICATOR, ETHICON LARGE, ROTATABLE         | 52133-04I   | 52555-01    | 52133-00   |
| 52133-11C | 10MM | 33CM   | LAP CLIP APPLICATOR, WECK SMALL, ROTATABLE            | 52133-11I   | 52555-01    | 52133-00   |
| 52133-12C | 10MM | 33CM   | LAP CLIP APPLICATOR, ETHICON MEDIUM, ROTATABLE        | 52133-12I   | 52555-01    | 52133-00   |
| 52133-13C | 10MM | 33CM   | LAP CLIP APPLICATOR, ETHICON MEDIUM-LARGE, ROTATABLE  | 52133-13I   | 52555-01    | 52133-00   |
| 52133-41C | 10MM | 33CM   | LAP CLIP APPLICATOR, HORIZON, SMALL, ROTATABLE        | 52133-41I   | 52555-01    | 52133-00   |
| 52133-42C | 10MM | 33CM   | LAP CLIP APPLICATOR, HORIZON, MEDIUM, ROTATABLE       | 52133-42I   | 52555-01    | 52133-00   |
| 52133-43C | 10MM | 33CM   | LAP CLIP APPLICATOR, HORIZON, MEDIUM-LARGE, ROTATABLE | 52133-43I   | 52555-01    | 52133-00   |
| 52525-84C | 10MM | 45CM   | LAP CLIP APPLICATOR, ETHICON SMALL, ROTATABLE         | 52525-84I   | 52555-01    | 52133-01   |
| 52525-85C | 10MM | 45CM   | LAP CLIP APPLICATOR, ETHICON MEDIUM, ROTATABLE        | 52525-85I   | 52555-01    | 52133-01   |
| 52525-86C | 10MM | 45CM   | LAP CLIP APPLICATOR, ETHICON MEDIUM-LARGE, ROTATABLE  | 52525-86I   | 52555-01    | 52133-01   |
| 52525-87C | 10MM | 45CM   | LAP CLIP APPLICATOR, ETHICON LARGE, ROTATABLE         | 52525-87I   | 52555-01    | 52133-01   |









# ELMED LAPAROSCOPIC 5MM NEEDLE HOLDERS



MADE IN THE USA

| TIP ID.  | DIAMETER | LENGTH | 52555-40-12   | 52555-40-19  | 52555-40-32   |
|--|----------|--------|---|--|---|
|  |          |        | <br>STAINLESS STEEL,<br>RING AXIAL HANDLE<br>W/RATCHET | <br>LIGHT WEIGHT<br>AXIAL HANDLE,<br>CURVED DOWN W/<br>RATCHET | <br>STRAIGHT AXIAL<br>HANDLE SA W/<br>ON/OFF RATCHET |
| HANDLE OPTIONS   |          |        |   |  |   |
| STRAIGHT 8MM TC<br>TIP<br>                   | 5MM      | 33CM   | 52505-45  | 52505-70   | 52505-85  |
|  | 5MM      | 36CM   | 52536-45  | 52536-70   | 52536-85  |
|  | 5MM      | 45CM   | 52515-45  | 52515-70   | 52515-85  |
| CURVED LEFT TC TIP<br>                     | 5MM      | 33CM   | 52505-46  | 52505-71   | 52505-86  |
|  | 5MM      | 36CM   | 52536-46  | 52536-71   | 52536-86  |
|  | 5MM      | 45CM   | 52515-46  | 52515-71   | 52515-86  |
| CURVED RIGHT TC<br>TIP<br>                 | 5MM      | 33CM   | 52505-47  | 52505-72   | 52505-87  |
|  | 5MM      | 36CM   | 52536-47  | 52536-72   | 52536-87  |
|  | 5MM      | 45CM   | 52515-47  | 52515-72   | 52515-87  |
| OPEN SELF RIGHTING<br>NEEDLE TIP<br>       | 5MM      | 33CM   | 52505-66  | 52505-73   | 52505-88  |
|  | 5MM      | 36CM   | 52536-66  | 52536-73   | 52536-88  |
|  | 5MM      | 45CM   | 52515-66  | 52515-73   | 52515-88  |
| CLOSED SELF<br>RIGHTING NEEDLE<br>TIP<br> | 5MM      | 33CM   | 52505-67  | 52505-74   | 52505-89  |
|  | 5MM      | 36CM   | 52536-67  | 52536-74   | 52536-89  |
|  | 5MM      | 45CM   | 52515-67  | 52515-74   | 52515-89  |





# ELMED LAPAROSCOPIC 5MM NEEDLE HOLDERS



MADE IN THE USA

| TIP ID.   | DIAMETER | LENGTH | 52555-40-20   | 52555-40-21  | 52555-40-26  |
|---|----------|--------|---|--|--|
|   |          |        | <br>STRAIGHT AXIAL HANDLE SA W/ ON/OFF RATCHET | <br>LIGHTWEIGHT STRAIGHT AXIAL HANDLE W/ RATCHET | <br>ALUMINUM AXIAL HANDLE, CURVED DOWN W/ RATCHET |
| HANDLE OPTIONS  |          |        |   |  |  |
| STRAIGHT 8MM TC TIP<br>               | 5MM      | 33CM   |   | 52505-77   | 52505-70P  |
|   | 5MM      | 36CM   |   | 52536-77   | 52536-70P  |
|   | 5MM      | 45CM   |   | 52515-77   | 52515-70P  |
| CURVED LEFT TC TIP<br>              | 5MM      | 33CM   |   | 52505-78   | 52505-71P  |
|   | 5MM      | 36CM   |   | 52536-78   | 52536-71P  |
|   | 5MM      | 45CM   |   | 52515-78   | 52515-71P  |
| CURVED RIGHT TC TIP<br>             | 5MM      | 33CM   |   | 52505-79   | 52505-72P  |
|   | 5MM      | 36CM   |   | 52536-79   | 52536-72P  |
|   | 5MM      | 45CM   |   | 52515-79   | 52515-72P  |
| OPEN SELF RIGHTING NEEDLE TIP<br>   | 5MM      | 33CM   |   | 52505-82   | 52505-73P  |
|   | 5MM      | 36CM   |   | 52536-82   | 52536-73P  |
|   | 5MM      | 45CM   |   | 52515-82   | 52515-73P  |
| CLOSED SELF RIGHTING NEEDLE TIP<br> | 5MM      | 33CM   |   | 52505-83   | 52505-74P  |
|   | 5MM      | 36CM   |   | 52536-83   | 52536-74P  |
|   | 5MM      | 45CM   |   | 52515-83   | 52515-74P  |







# ELMED LAPAROSCOPIC 5MM NEEDLE HOLDERS



MADE IN THE USA

| TIP ID.   | DIAMETER | LENGTH | 52555-40-27   | 52555-40-13   |  |
|---|----------|--------|---|---|--|
|   |          |        | <br>ALUMINUM STRAIGHT AXIAL HANDLE SA W/ RATCHET | <br>STRAIGHT AXIAL HANDLE, DA W/ RATCHET |  |
| HANDLE OPTIONS  |          |        |   |   |  |
| STRAIGHT 8MM TC TIP<br>              | 5MM      | 33CM   | 52505-85P   | 52505-60  |  |
|   | 5MM      | 36CM   | 52536-85P   | 52536-60  |  |
|   | 5MM      | 45CM   | 52515-85P   | 52515-60  |  |
| CURVED LEFT TC TIP<br>              | 5MM      | 33CM   | 52505-86P   | 52505-62  |  |
|   | 5MM      | 36CM   | 52536-86P   | 52536-62  |  |
|   | 5MM      | 45CM   | 52515-86P   | 52515-62  |  |
| CURVED RIGHT TC TIP<br>             | 5MM      | 33CM   | 52505-87P   | 52505-63  |  |
|   | 5MM      | 36CM   | 52536-87P   | 52536-63  |  |
|   | 5MM      | 45CM   | 52515-87P   | 52515-63  |  |
| OPEN SELF RIGHTING NEEDLE TIP<br>   | 5MM      | 33CM   | 52505-88P   | 52505-64  |  |
|   | 5MM      | 36CM   | 52536-88P   | 52536-64  |  |
|   | 5MM      | 45CM   | 52515-88P   | 52515-64  |  |
| CLOSED SELF RIGHTING NEEDLE TIP<br> | 5MM      | 33CM   | 52505-74P   | 52505-89P   |  |
|   | 5MM      | 36CM   | 52536-74P   | 52536-89P   |  |
|   | 5MM      | 45CM   | 52515-74P   | 52515-89P   |  |











# ELMED MODULAR SCREW-APART LAPAROSCOPIC 5MM NEEDLE HOLDERS



MADE IN THE USA

| TIP ID.  | DIAMETER | LENGTH | INSERT NO. | 52555-40-12   | 52555-40-19   |
|--|----------|--------|------------|---|---|
|  |          |        |            | <br>STAINLESS STEEL, RING<br>AXIAL HANDLE W/<br>RATCHET | <br>LIGHT WEIGHT<br>AXIAL HANDLE, CURVED<br>DOWN W/RATCHET |
| HANDLE OPTIONS   |          |        |            |   |   |
| STRAIGHT 8MM TC TIP<br>                  | 5MM      | 33CM   | 52505-60I  | 52505-45C   | 52505-70C   |
|  | 5MM      | 36CM   | 52536-60I  | 52536-45C   | 52536-70C   |
|  | 5MM      | 45CM   | 52515-60I  | 52515-45C   | 52515-70C   |
| CURVED LEFT TC TIP<br>                 | 5MM      | 33CM   | 52505-62I  | 52505-46C   | 52505-71C   |
|  | 5MM      | 36CM   | 52536-62I  | 52536-46C   | 52536-71C   |
|  | 5MM      | 45CM   | 52515-62I  | 52515-46C   | 52515-71C   |
| CURVED RIGHT TC TIP<br>                | 5MM      | 33CM   | 52505-63I  | 52505-47C   | 52505-72C   |
|  | 5MM      | 36CM   | 52536-63I  | 52536-47C   | 52536-72C   |
|  | 5MM      | 45CM   | 52515-63I  | 52515-47C   | 52515-72C   |
| OPEN SELF RIGHTING<br>NEEDLE TIP<br>   | 5MM      | 33CM   | 52505-64I  | 52505-66C   | 52505-73C   |
|  | 5MM      | 36CM   | 52536-64I  | 52536-66C   | 52536-73C   |
|  | 5MM      | 45CM   | 52515-64I  | 52515-66C   | 52515-73C   |
| CLOSED SELF RIGHTING<br>NEEDLE TIP<br> | 5MM      | 33CM   | 52505-65I  | 52505-67C   | 52505-74C   |
|  | 5MM      | 36CM   | 52536-65I  | 52536-67C   | 52536-74C   |
|  | 5MM      | 45CM   | 52515-65I  | 52515-67C   | 52515-74C   |







# ELMED MODULAR SCREW-APART LAPAROSCOPIC 5MM NEEDLE HOLDERS



MADE IN THE USA

| TIP ID.   | DIAMETER | LENGTH | INSERT NO. | 52555-40-32  | 52555-40-13   |
|---|----------|--------|------------|--|---|
|   |          |        |            |  |  |
|   |          |        |            | STRAIGHT AXIAL<br>HANDLE SA W/<br>ON/OFF RATCHET                                   | STRAIGHT AXIAL<br>HANDLE SA W/ON/<br>OFF RATCHET                                    |
| HANDLE OPTIONS  |          |        |            |  |   |
| STRAIGHT 8MM TC TIP<br>                  | 5MM      | 33CM   | 52505-60I  | 52505-85C  |   |
|   | 5MM      | 36CM   | 52536-60I  | 52536-85C  |   |
|   | 5MM      | 45CM   | 52515-60I  | 52515-85C  |   |
| CURVED LEFT TC TIP<br>                  | 5MM      | 33CM   | 52505-62I  | 52505-86C  |   |
|   | 5MM      | 36CM   | 52536-62I  | 52536-86C  |   |
|   | 5MM      | 45CM   | 52515-62I  | 52515-86C  |   |
| CURVED RIGHT TC TIP<br>                 | 5MM      | 33CM   | 52505-63I  | 52505-87C  |   |
|   | 5MM      | 36CM   | 52536-63I  | 52536-87C  |   |
|   | 5MM      | 45CM   | 52515-63I  | 52515-87C  |   |
| OPEN SELF RIGHTING<br>NEEDLE TIP<br>   | 5MM      | 33CM   | 52505-64I  | 52505-88C  |   |
|   | 5MM      | 36CM   | 52536-64I  | 52536-88C  |   |
|   | 5MM      | 45CM   | 52515-64I  | 52515-88C  |   |
| CLOSED SELF RIGHTING<br>NEEDLE TIP<br> | 5MM      | 33CM   | 52505-65I  | 52505-89C  |   |
|   | 5MM      | 36CM   | 52536-65I  | 52536-89C  |   |
|   | 5MM      | 45CM   | 52515-65I  | 52515-89C  |   |





# ELMED MODULAR SCREW-APART LAPAROSCOPIC 5MM NEEDLE HOLDERS



MADE IN THE USA

| TIP ID.   | DIAMETER | LENGTH | INSERT NO. | 52555-40-22   | 52555-40-26   |
|---|----------|--------|------------|---|---|
|   |          |        |            |  |  |
|   |          |        |            | LIGHTWEIGHT STRAIGHT AXIAL HANDLE W/ RATCHET  | ALUMINUM AXIAL HANDLE, CURVED DOWN W/ RATCHET                                       |
| HANDLE OPTIONS  |          |        |            |   |   |
| STRAIGHT 8MM TC TIP<br>                  | 5MM      | 33CM   | 52505-60I  | 52505-77C   | 52505-70PC  |
|   | 5MM      | 36CM   | 52536-60I  | 52536-77C   | 52536-70PC  |
|   | 5MM      | 45CM   | 52515-60I  | 52515-77C   | 52515-70PC  |
| CURVED LEFT TC TIP<br>                  | 5MM      | 33CM   | 52505-62I  | 52505-78C   | 52505-71PC  |
|   | 5MM      | 36CM   | 52536-62I  | 52536-78C   | 52536-71PC  |
|   | 5MM      | 45CM   | 52515-62I  | 52515-78C   | 52515-71PC  |
| CURVED RIGHT TC TIP<br>                 | 5MM      | 33CM   | 52505-63I  | 52505-79C   | 52505-72PC  |
|   | 5MM      | 36CM   | 52536-63I  | 52536-79C   | 52536-72PC  |
|   | 5MM      | 45CM   | 52515-63I  | 52515-79C   | 52515-72PC  |
| OPEN SELF RIGHTING<br>NEEDLE TIP<br>    | 5MM      | 33CM   | 52505-64I  | 52505-82C   | 52505-73PC  |
|   | 5MM      | 36CM   | 52536-64I  | 52536-82C   | 52536-73PC  |
|   | 5MM      | 45CM   | 52515-64I  | 52515-82C   | 52515-73PC  |
| CLOSED SELF RIGHTING<br>NEEDLE TIP<br> | 5MM      | 33CM   | 52505-65I  | 52505-83C   | 52505-74PC  |
|   | 5MM      | 36CM   | 52536-65I  | 52536-83C   | 52536-74PC  |
|   | 5MM      | 45CM   | 52515-65I  | 52515-83C   | 52515-74PC  |











# ELMED MODULAR SCREW-APART LAPAROSCOPIC 5MM NEEDLE HOLDERS



MADE IN THE USA

| TIP ID.  | DIAMETER | LENGTH | INSERT NO. | 52555-40-27  | 52555-40-13   |
|--|----------|--------|------------|--|---|
|  |          |        |            | <br>ALUMINUM STRAIGHT AXIAL HANDLE SA W/ RATCHET | <br>STRAIGHT AXIAL HANDLE, DA W/ RATCHET |
| <b>HANDLE OPTIONS</b>  |          |        |            |  |   |
| STRAIGHT 8MM TC TIP<br>                 | 5MM      | 33CM   | 52505-60I  | 52505-85PC   | 52505-60C   |
|  | 5MM      | 36CM   | 52536-60I  | 52536-85PC   | 52536-60C   |
|  | 5MM      | 45CM   | 52515-60I  | 52515-85PC   | 52515-60C   |
| CURVED LEFT TC TIP<br>                 | 5MM      | 33CM   | 52505-62I  | 52505-86PC   | 52505-62C   |
|  | 5MM      | 36CM   | 52536-62I  | 52536-86PC   | 52536-62C   |
|  | 5MM      | 45CM   | 52515-62I  | 52515-86PC   | 52515-62C   |
| CURVED RIGHT TC TIP<br>                | 5MM      | 33CM   | 52505-63I  | 52505-87PC   | 52505-63C   |
|  | 5MM      | 36CM   | 52536-63I  | 52536-87PC   | 52536-63C   |
|  | 5MM      | 45CM   | 52515-63I  | 52515-87PC   | 52515-63C   |
| OPEN SELF RIGHTING<br>NEEDLE TIP<br>   | 5MM      | 33CM   | 52505-64I  | 52505-88PC   | 52505-64C   |
|  | 5MM      | 36CM   | 52536-64I  | 52536-88PC   | 52536-64C   |
|  | 5MM      | 45CM   | 52515-64I  | 52515-88PC   | 52515-64C   |
| CLOSED SELF RIGHTING<br>NEEDLE TIP<br> | 5MM      | 33CM   | 52505-65I  | 52505-89PC   | 52505-65C   |
|  | 5MM      | 36CM   | 52536-65I  | 52536-89PC   | 52536-65C   |
|  | 5MM      | 45CM   | 52515-65I  | 52515-89PC   | 52515-65C   |











# ELMED MODULAR SCREW-APART LAPAROSCOPIC 5MM NEEDLE HOLDERS



MADE IN THE USA

| TIP ID.   | DIAMETER | LENGTH | INSERT NO.       | HANDLE OPTIONS  |
|---|----------|--------|------------------|---|
|   |          |        |                  |  |
| STRAIGHT 8MM TC TIP   |          |        |                  |   |
|   | 5MM      | 33CM   | <b>52505-60I</b> |   |
|   | 5MM      | 36CM   | <b>52536-60I</b> |   |
|   | 5MM      | 45CM   | <b>52515-60I</b> |   |
| CURVED LEFT TC TIP  |          |        |                  |   |
|  | 5MM      | 33CM   | <b>52505-62I</b> |   |
|   | 5MM      | 36CM   | <b>52536-62I</b> |   |
|   | 5MM      | 45CM   | <b>52515-62I</b> |   |
| CURVED RIGHT TC TIP   |          |        |                  |   |
|  | 5MM      | 33CM   | <b>52505-63I</b> |   |
|   | 5MM      | 36CM   | <b>52536-63I</b> |   |
|   | 5MM      | 45CM   | <b>52515-63I</b> |   |
| OPEN SELF RIGHTING<br>NEEDLE TIP  |          |        |                  |   |
|  | 5MM      | 33CM   | <b>52505-64I</b> |   |
|   | 5MM      | 36CM   | <b>52536-64I</b> |   |
|   | 5MM      | 45CM   | <b>52515-64I</b> |   |
| CLOSED SELF RIGHTING<br>NEEDLE TIP  |          |        |                  |   |
|  | 5MM      | 33CM   | <b>52505-65I</b> |   |
|   | 5MM      | 36CM   | <b>52536-65I</b> |   |
|   | 5MM      | 45CM   | <b>52515-65I</b> |   |





# NEEDLE HOLDERS



MADE IN THE USA

| ITEM NO.        | DESCRIPTION   |
|-----------------|---|
| <b>52505-19</b> | 5MM DIA., 32CM NEEDLE HOLDER ACCORDING TO DR. SEMM, SPRING SCISSOR HANDLE |



| ITEM NO.           | DESCRIPTION  |
|--------------------|--|
| <b>52515-95B10</b> | 5MM, 45CM LAP COMBINATION NEEDLE HOLDER/KNOT PUSHER, DOUBLE ACTION SLOTTED JAW W/ SERRATED LOWER JAW AND DIAMOND DUSTED UPPER JAW, 3.5MM WIDE AT TIP, INSULATED SHAFT, #10 CARBON FIBER HANDLE W/ ON-OFF LOCK, ROTATABLE ONE PIECE W/ FLUSH PORT |





# ELMED KNOT PUSHERS



MADE IN THE USA

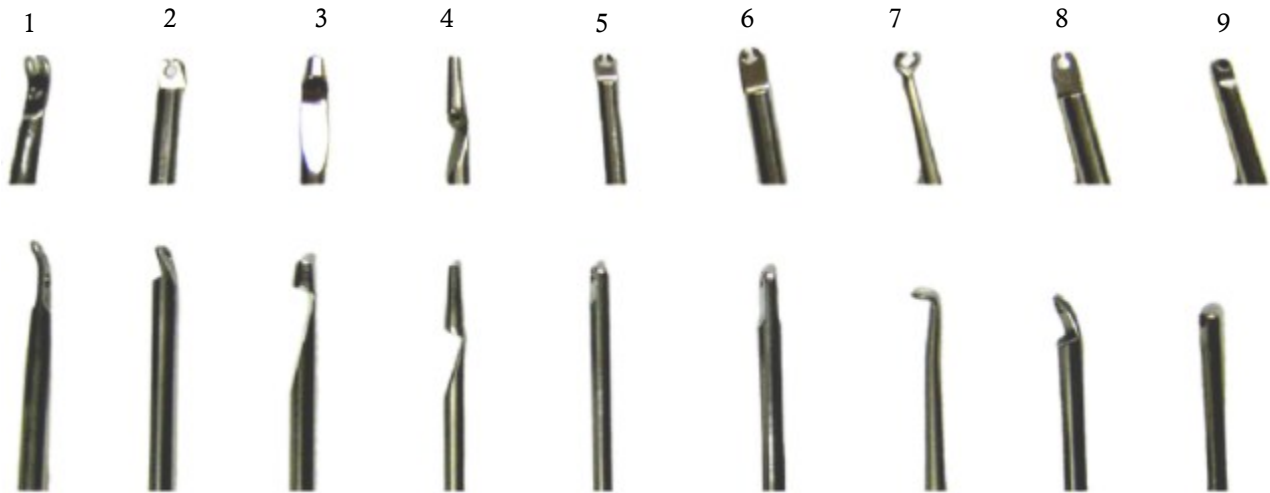

| DESCRIPTION  | ITEM NO. (33CM)              | ITEM NO. (45CM)              |
|--|------------------------------|------------------------------|
| ELMED KNOT PUSHER, STAINLESS STEEL 5MM DIA., STYLE 1         | <a href="#">52205-61-01</a>  | <a href="#">52105-61-01</a>  |
| ELMED KNOT PUSHER, STAINLESS STEEL 5MM DIA., STYLE 2         | <a href="#">52205-61-02</a>  | <a href="#">52105-61-02</a>  |
| ELMED KNOT PUSHER, STAINLESS STEEL 5MM DIA., STYLE 3         | <a href="#">52205-61-03</a>  | <a href="#">52105-61-03</a>  |
| ELMED KNOT PUSHER, STAINLESS STEEL 5MM DIA., STYLE 4         | <a href="#">52205-61-04</a>  | <a href="#">52105-61-04</a>  |
| ELMED KNOT PUSHER, STAINLESS STEEL 5MM DIA., STYLE 5         | <a href="#">52205-61-05</a>  | <a href="#">52105-61-05</a>  |
| ELMED KNOT PUSHER, STAINLESS STEEL 5MM DIA., STYLE 6         | <a href="#">52205-61-06</a>  | <a href="#">52105-61-06</a>  |
| ELMED KNOT PUSHER, STAINLESS STEEL 5MM DIA., STYLE 7         | <a href="#">52205-61-07</a>  | <a href="#">52105-61-07</a>  |
| ELMED KNOT PUSHER, STAINLESS STEEL 5MM DIA., STYLE 8         | <a href="#">52205-61-08</a>  | <a href="#">52105-61-08</a>  |
| ELMED KNOT PUSHER, STAINLESS STEEL 5MM DIA., STYLE 9         | <a href="#">52205-61-09</a>  | <a href="#">52105-61-09</a>  |
| ELMED KNOT PUSHER, CLOSED, STAINLESS STEEL 5MM DIA., STYLE 1 | <a href="#">52205-61-01C</a> | <a href="#">52105-61-01C</a> |
| ELMED KNOT PUSHER, CLOSED, STAINLESS STEEL 5MM DIA., STYLE 2 | <a href="#">52205-61-02C</a> | <a href="#">52105-61-02C</a> |
| ELMED KNOT PUSHER, CLOSED, STAINLESS STEEL 5MM DIA., STYLE 5 | <a href="#">52205-61-05C</a> | <a href="#">52105-61-05C</a> |
| ELMED KNOT PUSHER, CLOSED, STAINLESS STEEL 5MM DIA., STYLE 6 | <a href="#">52205-61-06C</a> | <a href="#">52105-61-06C</a> |
| ELMED KNOT PUSHER, CLOSED, STAINLESS STEEL 5MM DIA., STYLE 7 | <a href="#">52205-61-07C</a> | <a href="#">52105-61-07C</a> |
| ELMED KNOT PUSHER, CLOSED, STAINLESS STEEL 5MM DIA., STYLE 8 | <a href="#">52205-61-08C</a> | <a href="#">52105-61-08C</a> |





# LAPAROSCOPIC SUTURE PASSER



MADE IN THE USA



*SPRING  
HANDLE*



*SYRINGE STYLE*



PRECISION MICRO-POINTED AND POLISHED TIP WITH PLATFORM ON ALL OF SUTURE RETRIEVERS

|                  |   |
|------------------|---|
| <b>52203-41</b>  | ELMED LAPAROSCOPIC TROCAR INCISION WOUND CLOSURE & HERNIA SUTURE RETRIEVER- 3.0MM DIA., 17CM WORKING LENGTH, SPRING HANDLE, CLEANING FLUSH PORT                             |
| <b>52203-41C</b> | ELMED LAPAROSCOPIC TROCAR INCISION WOUND CLOSURE & HERNIA SUTURE RETRIEVER- 3.0MM DIA., 17CM WORKING LENGTH, SPRING HANDLE, CLEANING FLUSH PORT (2-PIECE MODULAR)           |
| <b>52213-41</b>  | ELMED BARIATRIC LAPAROSCOPIC TROCAR INCISION WOUND CLOSURE & HERNIA SUTURE RETRIEVER- 3.0MM DIA., 20CM WORKING LENGTH, SPRING HANDLE, CLEANING FLUSH PORT                   |
| <b>52213-41C</b> | ELMED BARIATRIC LAPAROSCOPIC TROCAR INCISION WOUND CLOSURE & HERNIA SUTURE RETRIEVER- 3.0MM DIA., 20CM WORKING LENGTH, SPRING HANDLE, CLEANING FLUSH PORT (2-PIECE MODULAR) |
| <b>52203-00</b>  | ELMED LAPAROSCOPIC TROCAR INCISION WOUND CLOSURE & HERNIA SUTURE RETRIEVER- 3.0MM DIA., 17CM WORKING LENGTH, SYRINGE HANDLE, CLEANING FLUSH PORT                            |
| <b>52213-00</b>  | ELMED LAPAROSCOPIC TROCAR INCISION WOUND CLOSURE & HERNIA SUTURE RETRIEVER- 3.0MM DIA., 20CM WORKING LENGTH, SYRINGE HANDLE, CLEANING FLUSH PORT                            |

## STAINLESS STEEL TROCAR GUIDE CONES

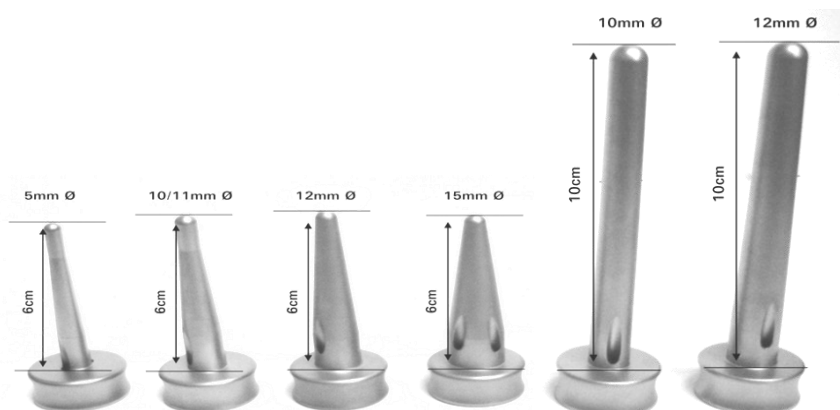

6CM LENGTH

|                    |                  |
|--------------------|------------------|
| <b>52203-05</b>    | 5MM DIAMETER     |
| <b>52203-10/11</b> | 10/11MM DIAMETER |
| <b>52203-12</b>    | 12MM DIAMETER    |
| <b>52203-15</b>    | 15MM DIAMETER    |

10CM LENGTH

|                    |                  |
|--------------------|------------------|
| <b>52204-05</b>    | 5MM DIAMETER     |
| <b>52204-10/11</b> | 10/11MM DIAMETER |
| <b>52204-12</b>    | 12MM DIAMETER    |
| <b>52204-15</b>    | 15MM DIAMETER    |





# SPECIALTY *LAP* INSTRUMENTS

*ELMED* EXCELS IN BRINGING HIGH QUALITY INSTRUMENTATION AT VERY AFFORDABLE PRICING. OUR SPECIALTY LAP INSTRUMENTS FOLLOW THIS SAME MOTTO.



# HASSON 3-PRONG GRASPER



MADE IN THE USA

THE ULTIMATE LAPAROSCOPIC INSTRUMENT FOR RETRACTION OF MYOMAS, FIBROIDS, OVARIES & OTHER ORGANS



**52505-52**

5MM, 32CM, 3-PRONG BULLDOG HASSON GRASPER AGGRESSIVE JAWS

**52505-53**

5MM, 32CM, 3-PRONG BULLDOG HASSON GRASPER CURVED ALLIS TEETH

**52515-52**

5MM, 45CM, 3-PRONG BULLDOG HASSON GRASPER AGGRESSIVE JAWS

**52515-53**

5MM, 45CM, 3-PRONG BULLDOG HASSON GRASPER CURVED ALLIS TEETH



**52505-54**

5MM, 32CM, 3-PRONG BULLDOG HASSON GRASPER STRAIGHT ALLIS TEETH

**52505-55**

5MM, 32CM, 3-PRONG HASSON GRASPER, BLUNT EDGED JAWS

**52515-54**

5MM, 45CM, 3-PRONG BULLDOG HASSON GRASPER STRAIGHT ALLIS TEETH

**52515-55**

5MM, 45CM, 3-PRONG HASSON GRASPER, BLUNT EDGED JAWS

## MYOMA SCREW



Precision Machined Tip

SOLID STAINLESS STEEL CONSTRUCTION WITH PRECISION MACHINED TIP FOR PRECISE MANIPULATION AND SECURING OF THICK WALLED MYOMAS. COMPLETELY REUSABLE, HELPING REDUCE YOUR SPIRALING SURGICAL PROCEDURE COSTS.

**52505-98**

5MM Ø, 33CM WORKING LENGTH MYOMA SCREW

**52505-99**

10MM Ø, 33CM WORKING LENGTH MYOMA SCREW

**52515-98**

5MM Ø, 45CM WORKING LENGTH MYOMA SCREW

**52515-99**

10MM Ø, 45CM WORKING LENGTH MYOMA SCREW





# CHOLANGIOGRAM CLAMP



MADE IN THE USA



|                 |  |
|-----------------|--|
| <b>52505-32</b> | 5MM Ø, 27CM WORKING LENGTH CHOLANGIOGRAM CLAMP |
| <b>52505-33</b> | 5MM Ø, 32CM WORKING LENGTH CHOLANGIOGRAM CLAMP |
| <b>52505-34</b> | 5MM Ø, 36CM WORKING LENGTH CHOLANGIOGRAM CLAMP |
| <b>52505-35</b> | 5MM Ø, 45CM WORKING LENGTH CHOLANGIOGRAM CLAMP |

*\*\*\*ALL 5MM DIAMETER,  
4 DIFFERENT WORKING LENGTHS*

## ENDOSCOPIC MAGNETIC ROD

STAINLESS STEEL CONSTRUCTION WITH SERRATED HANDLE FOR PRECISE  
**\*\*IMPORTANT: INSTRUMENT TO BE USED ONLY UNDER DIRECT VISION\*\***



|                 |                                       |                 |  |
|-----------------|---------------------------------------|-----------------|--|
| <b>52805-01</b> | 5MM Ø, 33CM LAPAROSCOPIC MAGNETIC ROD | <b>52810-01</b> | 10MM Ø, 33CM LAPAROSCOPIC MAGNETIC ROD |
| <b>52805-02</b> | 5MM Ø, 45CM LAPAROSCOPIC MAGNETIC ROD | <b>52810-02</b> | 10MM Ø, 45CM LAPAROSCOPIC MAGNETIC ROD |
| <b>52803-01</b> | 3MM Ø, 33CM LAPAROSCOPIC MAGNETIC ROD |                 |  |
| <b>52803-02</b> | 3MM Ø, 45CM LAPAROSCOPIC MAGNETIC ROD |                 |  |

## RETRACTABLE ENDOSCOPIC KNIFE



**52505-18** | 5MM, 36CM, RETRACTABLE ENDOSCOPIC KNIFE, W/ REPLACEABLE BEAVER BLADE





# ATRAUMATIC LONG JAW CHOLANGIOGRAM CLAMP



MADE IN THE USA

THE ELMED ATRAUMATIC LONG JAW CHOLANGIOGRAM CLAMP IS A VALUABLE INSTRUMENT USED IN LAPAROSCOPIC CHOLANGIOGRAPHY IN THE DETECTION OF DUCT STONES, VISUALIZATION OF DUCTAL ANOMALIES AND DISCOVERY AND PREVENTION OF INDUCED INJURIES TO THE BILE DUCTS.

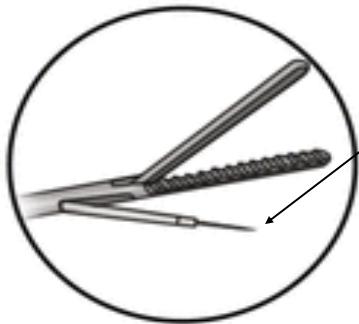
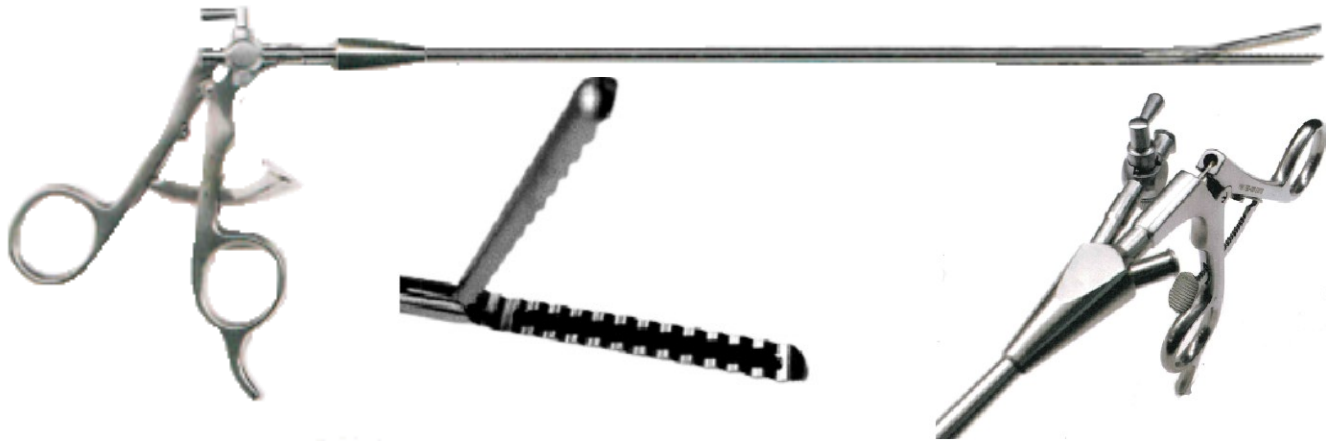

SHOWN 19 GAUGE (4.5 FR.) CATHETER WITH 22 NEEDLE  
NOTE: INSIDE DIAMETER OF CATHETER CHANNEL IS 16 GAUGE

| ITEM No. | DIA. | WORKING | DESCRIPTION  |
|----------|------|---------|--|
| 52505-41 | 5MM  | 33CM    | ELMED ALJ CHOLANGIOGRAM CLAMP SINGLE ACTION 40MM ATRAUMATIC JAW CATHETER CHANNEL W/ STOPCOCK STAINLESS STEEL SHAFT & HANDLE WITH RATCHET RIGID ONE-PIECE WITH FLUSHPORT—AUTOCLAVABLE |
| 52510-41 | 5MM  | 36CM    | ELMED ALJ CHOLANGIOGRAM CLAMP SINGLE ACTION 40MM ATRAUMATIC JAW CATHETER CHANNEL W/ STOPCOCK STAINLESS STEEL SHAFT & HANDLE WITH RATCHET RIGID ONE-PIECE WITH FLUSHPORT—AUTOCLAVABLE |
| 52515-41 | 5MM  | 45CM    | ELMED ALJ CHOLANGIOGRAM CLAMP SINGLE ACTION 40MM ATRAUMATIC JAW CATHETER CHANNEL W/ STOPCOCK STAINLESS STEEL SHAFT & HANDLE WITH RATCHET RIGID ONE-PIECE WITH FLUSHPORT—AUTOCLAVABLE |

*AUTOCLAVABLE MEDICAL GRADE STAINLESS STEEL*





# SILASTIC RING APPLICATOR FOR TUBULAR STERILIZATION



MADE IN THE USA

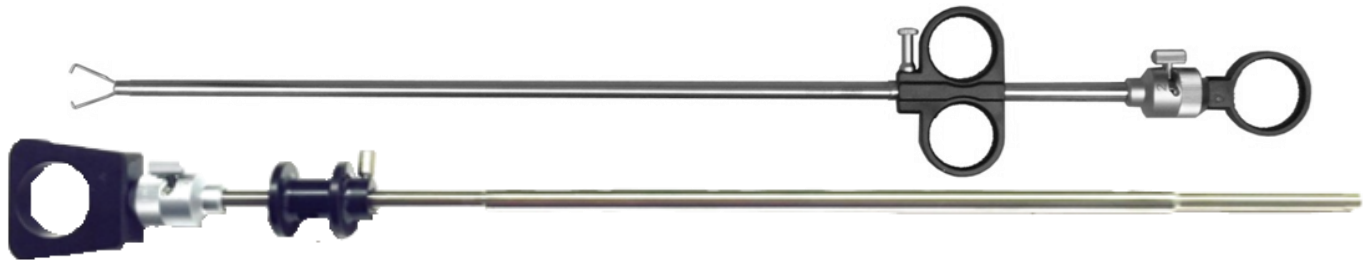

EXTENDED TIP



EXTENDED TIP  
W/ (1) SILASTIC RING



EXTENDED TIP  
W/ (2) SILASTIC RING

| ITEM NO.  | DESCRIPTION   |
|-----------|---|
| 52105-500 | 6MM Ø, 40CM SILASTIC RING APPLICATOR- FOR SINGLE AND DUAL RING APPLICATION; USE WITH OPERATING LAPAROSCOPE WITH 6MM Ø INSTRUMENT CHANNEL (SUGGEST ELMED ITEM NO. 52110-06).                   |
| 52205-501 | 6 MM Ø, 33CM SILASTIC RING APPLICATOR FOR SINGLE AND DUAL RING APPLICATION; USE WITH LAPAROSCOPE AND 6MM Ø TROCAR SLEEVE (SEE ELMED DATA SHEET FOR APPROPRIATE SLEEVE).                       |
| 52208-501 | 8MM Ø, 27CM SILASTIC RING APPLICATOR- FOR SINGLE AND DUAL RING APPLICATION; USE WITH LAPAROSCOPE AND 8MM Ø TROCAR SLEEVE (SEE ELMED DATA SHEET FOR APPROPRIATE SLEEVE). SAME DIAMETER AS ACMI |
| 52208-500 | 8MM Ø, 33CM SILASTIC RING APPLICATOR- FOR SINGLE AND DUAL RING APPLICATION; USE WITH LAPAROSCOPE AND 8MM Ø TROCAR SLEEVE (SEE ELMED DATA SHEET FOR APPROPRIATE SLEEVE). SAME DIAMETER AS ACMI |
| 52005-500 | SILASTIC RING (PACKAGE OF 10) FOR TUBAL LIGATION NON-STERILE, AUTOCLAVABLE  |
| 52005-501 | SILASTIC RING APPLICATOR AND GUIDE CONE SET (NOTE: (1) SET COMES WITH NEW INSTRUMENT)   |

## COHEN CANNULA



| ITEM NO.  | DESCRIPTION   |
|-----------|---|
| 52001-13  | COHEN CANNULA 2/ LARGE/SMALL REPLACEABLE TIPS                             |
| 52001-19L | REPLACEMENT ACORN, LARGE, FOR 52001-13                                    |
| 52001-19s | REPLACEMENT ACORN, SMALL, FOR 52001-13                                    |
| 52001-13W | COHEN CANNULA WITH LARGE/SMALL REPLACEABLE TIPS-SLOTTED HANDLE-WOLF STYLE |
| 52001-29  | 3MM CLEANING BRUSH FOR FRONT TUBE OF COHEN CANNULA (QTY 12/PACK)          |
| 52001-31  | 5MM CLEANING BRUSH FOR REAR TUBE OF COHEN CANNULA (QTY 12/PACK)           |

| ITEM NO.  | DESCRIPTION  |
|-----------|--|
| 52001-12s | COHEN CANNULA WITH FIXED SMALL STAINLESS STEEL ACORN             |
| 52001-12L | COHEN CANNULA WITH FIXED LARGE STAINLESS STEEL ACORN             |
| 52001-29  | 3MM CLEANING BRUSH FOR FRONT TUBE OF COHEN CANNULA (QTY 12/PACK) |
| 52001-31  | 5MM CLEANING BRUSH FOR REAR TUBE OF COHEN CANNULA (QTY 12/PACK)  |



# UTERINE MANIPULATOR



MADE IN THE USA

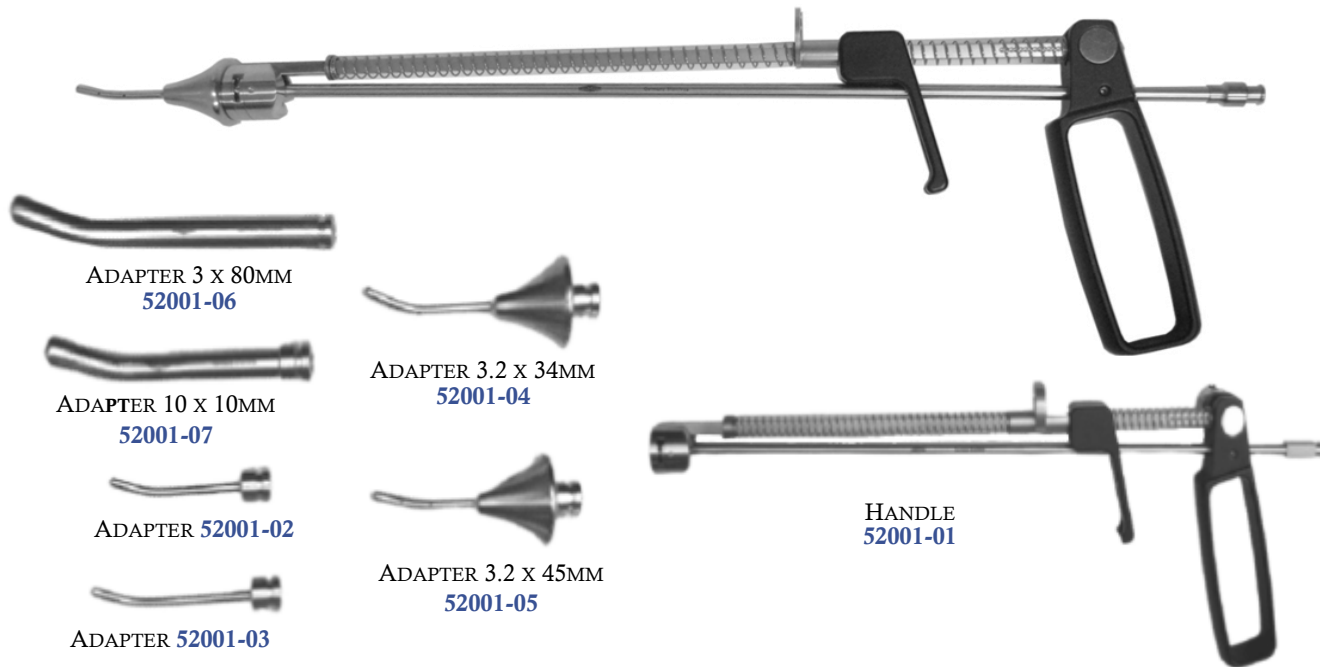

ADAPTER 3 x 80MM  
52001-06

ADAPTER 10 x 10MM  
52001-07

ADAPTER 52001-02

ADAPTER 52001-03

ADAPTER 3.2 x 34MM  
52001-04

ADAPTER 3.2 x 45MM  
52001-05

HANDLE  
52001-01

52001-00

ELMED V/T (VALTEHER/PELOSI) UTERINE MANIPULATOR: COMPLETE W/ SET OF (6) INTERCHANGEABLE OBTURATORS & CANNULA

# VALTCHEV UTERINE MOBILIZER



52001-00-6

ELEMED VALTCHEV UTERINE MOBILIZER SET: INCLUDES VALTCHEV UTERINE MOBILIZER, 2 CANNULAS OF DIFFERENT SIZE & 4 OBTURATORS OF DIFFERENT SIZE



# UTERINE TENACULA



MADE IN THE USA



**52001-09** | HULKA UTERINE MANIPULATOR  
TENACULUM



**52001-16** | BEHRMAN UTERINE MANIPULATOR  
TENACULUM



**52001-14** | SCHROEDER TENACULUM SINGLE  
TOOTH (9 1/2")



**52001-08** | SCHROEDER VULSELLUM DOUBLE  
TOOTH (9 1/2")



**52001-18** | SARGIS UTERINE GRASPING FORCEPS (9  
1/2")



**52001-17** | GIMPELSON CERVICAL SEALING  
TENACULUM (9 1/2")



# ASPIRATION NEEDLES



MADE IN THE USA

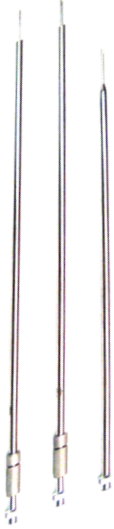

| ITEM NO.         | DESCRIPTION   |
|------------------|---|
| <b>52103-19</b>  | 3MM, 45CM INJECTION, ASPIRATION, & BIOPSY NEEDLE  |
| <b>52105-27</b>  | 5MM, 45CM ASPIRATION NEEDLE, 15 GA. NEEDLE SIZE- STANDARD (18 GA TO 25 GA AVAILABLE-PLEASE SPECIFY)                                 |
| <b>52105-27R</b> | 5MM, 45CM RETRACTABLE ASPIRATION NEEDLE, 15 GA. NEEDLE SIZE-STANDARD (18 GA. TO 25 GA. AVAILABLE - PLEASE SPECIFY)                  |
| <b>52105-27W</b> | 5MM DIA., 45CM ASPIRATION NEEDLE, WITH ANGLED 45° TUBE, 15 GA. NEEDLE SIZE - STANDARD (18 GA. TO 25 GA. AVAILABLE - PLEASE SPECIFY) |
| <b>52203-22</b>  | 3MM DIA., 33CM INJECTION, ASPIRATION AND BIOPSY NEEDLE  |
| <b>52205-31</b>  | 5MM DIA., 33CM ASPIRATION NEEDLE 15 GA. NEEDLE SIZE - STANDARD (18 GA. TO 25 GA. AVAILABLE- PLEASE SPECIFY)                         |
| <b>52205-31R</b> | 5MM DIA., 33CM RETRACTABLE ASPIRATION NEEDLE 15 GA. NEEDLE SIZE - STANDARD (18 GA. TO 25 GA. AVAILABLE- PLEASE SPECIFY)             |

## VERESS NEEDLES



| ITEM NO.        | DESCRIPTION                                      | ITEM NO.        | DESCRIPTION                                     |
|-----------------|--|-----------------|---|
| <b>52003-07</b> | 2MM DIA., 260MM (10") VERESS INSUFFLATION NEEDLE | <b>52003-10</b> | 2MM DIA., 100MM (4") VERESS INSUFFLATION NEEDLE |
| <b>52003-08</b> | 2MM DIA., 180MM (7") VERESS INSUFFLATION NEEDLE  | <b>52003-11</b> | 2MM DIA., 120MM (5") VERESS INSUFFLATION NEEDLE |
| <b>52003-09</b> | 2MM DIA., 55MM (2") VERESS INSUFFLATION NEEDLE   | <b>52003-12</b> | 2MM DIA., 150MM (6") VERESS INSUFFLATION NEEDLE |

## PALPATION TACTILE PROBES W/ CM MARKINGS



| ITEM NO.        | DESCRIPTION                                       |
|-----------------|---|
| <b>52205-29</b> | 5MM, 33CM, PALPATION TACTILE PROBE W/ CM MARKING  |
| <b>52105-25</b> | 5MM, 45CM, PALPATION TACTILE PROBE W/ CM MARKING  |
| <b>52133-25</b> | 10MM, 33CM, PALPATION TACTILE PROBE W/ CM MARKING |
| <b>52145-25</b> | 10MM, 45CM, PALPATION TACTILE PROBE W/ CM MARKING |





# SPECIALTY CANNULAS



MADE IN THE USA



| ITEM No.         | DESCRIPTION   |
|------------------|---|
| <b>52103-130</b> | 3MM Ø, 45CM REUSABLE STAINLESS STEEL CANNULA & OBTURATOR SET. CONSISTING OF:<br>(1) OUTER CANNULA 3MM Ø, 45CM WITH HANDLE & LUER LOCK FITTING (A)<br>(2) OBTURATOR 2.2MM Ø X 47CM WITH HANDLE & ROUND TIP (B)   |
| <b>52205-130</b> | 5MM Ø, 30CM REUSABLE STAINLESS STEEL CANNULA & OBTURATOR SET. CONSISTING OF::<br>(1) OUTER CANNULA 5MM Ø, 30CM WITH HANDLE & LUER LOCK FITTING (A)<br>(2) OBTURATOR 3.8MM Ø X 32CM WITH HANDLE & ROUND TIP (B)  |
| <b>52105-130</b> | 5MM Ø, 45CM REUSABLE STAINLESS STEEL CANNULA & OBTURATOR SET. CONSISTING OF::<br>(1) OUTER CANNULA 5MM Ø, 45CM WITH HANDLE & LUER LOCK FITTING (A)<br>(2) OBTURATOR 3.8MM Ø X 47CM WITH HANDLE & ROUND TIP (B)  |
| <b>52203-130</b> | 3MM Ø, 30CM REUSABLE STAINLESS STEEL CANNULA & OBTURATOR SET. CONSISTING OF::<br>(1) OUTER CANNULA 3MM Ø, 30CM WITH HANDLE & LUER LOCK FITTING (A)<br>(2) OBTURATOR 2.2MM Ø X 32CM WITH HANDLE & ROUND TIP (B)  |
| <b>52103-130</b> | 3MM Ø, 45CM REUSABLE STAINLESS STEEL CANNULA & OBTURATOR SET. CONSISTING OF::<br>(1) OUTER CANNULA 3MM Ø, 45CM WITH HANDLE & LUER LOCK FITTING (A)<br>(2) OBTURATOR 32.2MM Ø X 47CM WITH HANDLE & ROUND TIP (B) |

## HANDLES

CANNULA      OBTURATOR

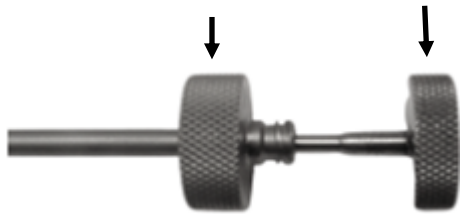

## TIPS—CANNULA & OBTURATOR





# SPECIALTY CANNULAS



MADE IN THE USA

| ITEM NO.        | DESCRIPTION  |
|-----------------|--|
| <b>52367-02</b> | FRANKENHEIM 2.5MM INSTRUMENT SET FOR SECOND PUNCTURE. COMPLETE SET |

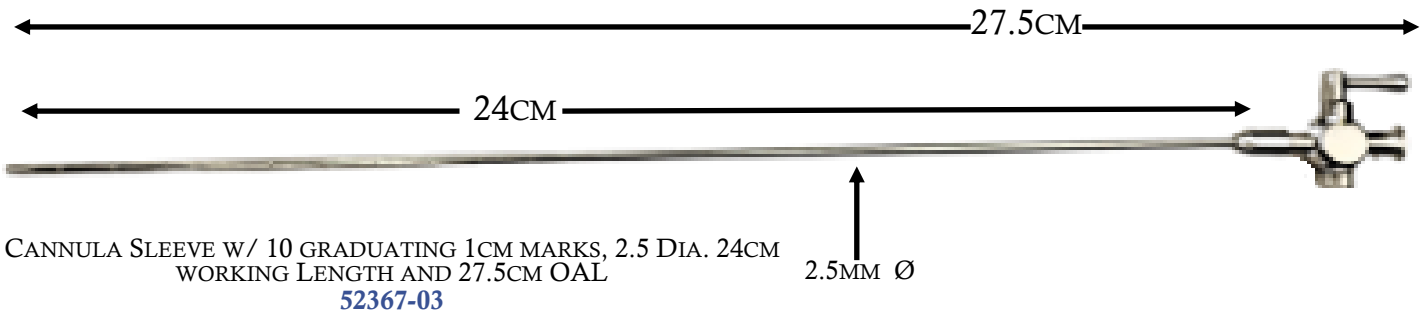

1CM MARKING  
"GRADUATING" CM  
MARKS



PYRAMID TIP  
**52367-12**



BLUNT TIP  
**52367-20**





# SELF-RETAINING RETRACTOR SYSTEMS & MINIMAL INVASIVE RETRACTORS

## **ELMED RETRACT-ROBOT, THE COMPLETE MECHANICAL RETRACTOR SYSTEM:**

THE MOST VERSATILE INSTRUMENT IN YOUR O.R., FOR USE IN LAPAROSCOPY AS A SCOPE HOLDER OR LIVER RETRACTOR, IN THORACIC, CARDIOVASCULAR & OPEN SURGERY, AS CHEST CAVITY AND BOWEL RETRACTOR, ETC.

WE ALSO OFFER A FULL RANGE OF LAPAROSCOPIC RETRACTORS.



# ELMED RETRACT ROBOT IN LAPAROSCOPIC SURGERY



MADE IN THE USA

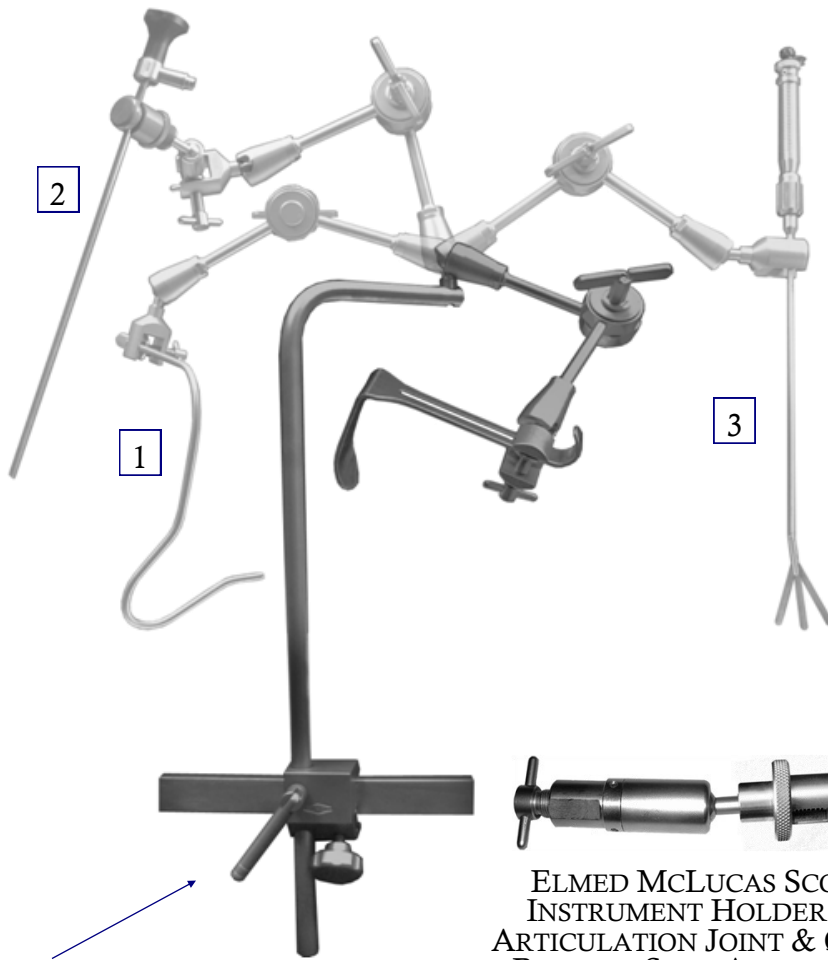

## VARIOUS INSTRUMENTS SHOWN WITH THE SINGLE-ARM RETRACT-ROBOT:

- 1) WITH THE NATHANSON LIVER RETRACTOR
- 2) WITH THE ARTICULATING SCOPE HOLDER: QUICK, STABLE & PRECISE ADJUSTMENT CAN BE MADE WITH THE TURN OF A KNOB.
- 3) WITH THE FAN RETRACTOR; ANY TYPE OF RETRACTOR CAN BE HELD IN A STABLE, FULLY ADJUSTABLE POSITION AT MAXIMUM RETRACTION, E.G. FLAT, ROUND, ETC.

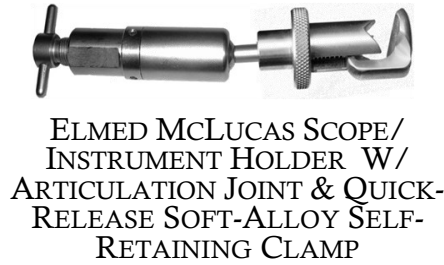

ELMED MCLUCAS SCOPE/  
INSTRUMENT HOLDER W/  
ARTICULATION JOINT & QUICK-  
RELEASE SOFT-ALLOY SELF-  
RETAINING CLAMP



ELMED EXTENSION CLAMP FOR  
BARIATRIC SURGERY (FITS INTO  
STERILE-CLAMP)

**THE ELMED STERIL-CLAMP:**  
PROVIDE SAFE AND STABLE  
MOUNTING IN STERILE CONDITION  
ON TOP OF THE DRAPE ON ANY  
OPERATING TABLE RAIL

| ITEM NO. | DESCRIPTION   |
|----------|---|
| 15088-00 | ELMED RETRACT-ROBOT SINGLE ARM INSTRUMENT   |
| 15088-01 | ELMED RETRACT-ROBOT SINGLE ARM INSTRUMENT W/ EXTRA-LONG MOUNTING ROD (26") (BARIATRIC)                                    |
| 15090-53 | ELMED STERIL-CLAMP HEAVY DUTY, 5/8" ROUND HOLE OR 1/2" X 1" SLOT (FOR EXTRA LONG ROBOT ARM)                               |
| 15090-56 | ELMED STERIL-CLAMP STANDARD, AUTOCLAVABLE W/ ROUND 5/8" ACCESSORY OPENING   |
| 15090-57 | ELMED EXTENSION CLAMP FOR BARIATRIC SURGERY: AUTOCLAVABLE, 5/8" ACCESSORY OPENING   |
| 52410-01 | ELMED SCOPE/INSTRUMENT HOLDER W/ ARTICULATION JOINT SELF-RETAINING CLAMP (SLEEVE STYLE)                                   |
| 52400-00 | ELMED ENDOSCOPIC FIXATION DEVICE CONSISTING OF: ITEM NO'S: <b>15088-00</b> , <b>15090-56</b> , & <b>52410-01</b>          |
| 52400-01 | ELMED BARIATRIC ENDOSCOPIC FIXATION DEVICE CONSISTING OF ITEM NO'S: <b>15088-01</b> , <b>15090-53</b> , & <b>52410-01</b> |



# ELMED GOOSE NECK RETRACTOR IN LAPAROSCOPIC SURGERY



MADE IN THE USA

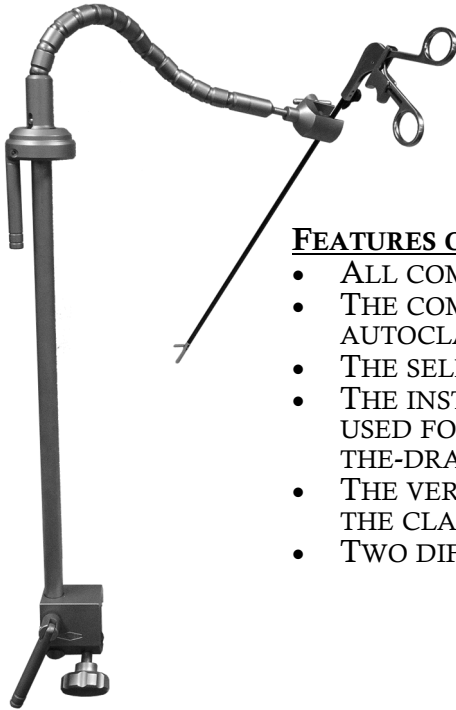

## FEATURES OF THE GOOSE-NECK SYSTEM:

- ALL COMPONENTS ARE MADE OF A HIGH GRADE STAINLESS STEEL.
- THE COMPLETE SYSTEM, INCLUDING THE STERIL-CLAMP™, MAY BE FLASH AUTOCLAVED
- THE SELF-RETAINING JOINTS ROTATE & TWIST IN EVERY DESIRABLE POSITION
- THE INSTRUMENT SHAFT FITS INTO TABLE ACCESSORY CLAMPS SUCH AS THOSE USED FOR STIRRUPS & LEG HOLDERS, AS WELL AS ALL OF THE OTHER OVER-THE-DRAPE CLAMPS WITH AN OPENING OF 5/8"
- THE VERTICAL SHAFT (5/8") MAY BE LOWERED OR HEIGHTENED WITHIN THE CLAMP FOR FLEXIBLE ADJUSTMENT
- TWO DIFFERENT MODELS WITH DIFFERENT INSTRUMENT HOLDERS AVAILABLE

| ITEM No. | DESCRIPTION  |
|----------|--|
| 15090-60 | ELMED GOOSE-NECK RETRACTOR SYSTEM WITH SELF-RETAINING SLEEVE CLAMP WITH ARTICULATING JOINT FOR HOLDING TELESCOPE INCLUDES 15090-56: STERIL-CLAMP™ FOR ATTACHING TO TABLE |
| 15090-61 | ELMED GOOSE-NECK RETRACTOR SYSTEM WITH UNIVERSAL MOUNTING CLAMP FOR HOLDING ALL TYPES OF INSTRUMENTS INCLUDES 15090-56: STERIL-CLAMP™ FOR ATTACHING TO TABLE             |

## RETRACT ROBOT & GOOSE NECK RETRACTOR STERILIZATION CONTAINERS

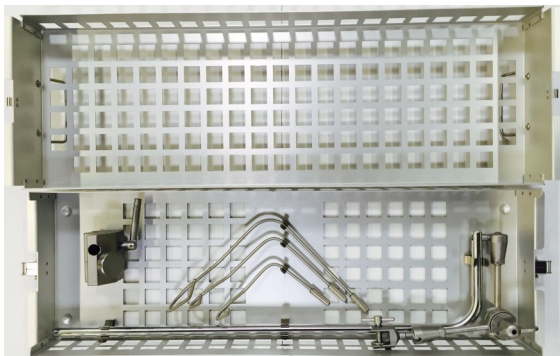

| ITEM No. | DESCRIPTION   |
|----------|---|
| 55040-03 | ELMED ALUMINUM STORAGE/STERILIZATION CONTAINER W/ PERFORATED LID & BOTTOM, W/ BRACKETS FOR MOUNTING RETRACT-ROBOT #15088-00 & #15090-53 OR 15090-56. (FOR WRAPPING) DIMENSIONS: 26"L X 10"W X 7"H (63.5CM X 25CM X 13CM).                         |
| 55040-02 | ELMED ALUMINUM STORAGE/STERILIZATION CONTAINER W/ PERFORATED LID & BOTTOM, W/ BRACKETS FOR MOUNTING RETRACT-ROBOT #15088-01 OR 15088-03 & STERIL-CLAMP #15090-53 OR 15090-56. (FOR WRAPPING.) DIMENSIONS: 30"L X 10"W X 6"H (76CM X 25CM X 15CM). |





# NATHANSON LIVER RETRACTORS



MADE IN THE USA

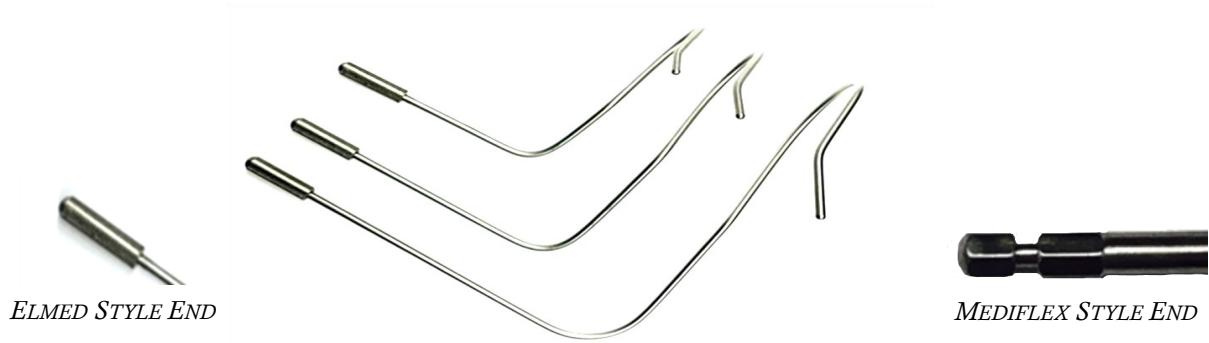

*ELMED STYLE END*

*MEDIFLEX STYLE END*

| ITEM NO.        | DESCRIPTION  | ITEM NO.        |
|-----------------|--|-----------------|
| <b>52420-00</b> | ELMED NATHANSON STYLE LIVER RETRACTORS 6.5MM DIA. SET OF 3 - SIZES: SMALL MEDIUM LARGE | <b>52440-00</b> |
| <b>52420-01</b> | ELMED NATHANSON STYLE LIVER RETRACTORS 6.5MM DIA.- SMALL                               | <b>52440-01</b> |
| <b>52420-02</b> | ELMED NATHANSON STYLE LIVER RETRACTORS 6.5MM DIA.- MEDIUM                              | <b>52440-02</b> |
| <b>52420-03</b> | ELMED NATHANSON STYLE LIVER RETRACTORS 6.5MM DIA.- LARGE                               | <b>52440-03</b> |
| <b>52430-00</b> | ELMED NATHANSON STYLE LIVER RETRACTORS 5MM DIA. SET OF 3 - SIZES: SMALL MEDIUM LARGE   | <b>52450-00</b> |
| <b>52430-01</b> | ELMED NATHANSON STYLE LIVER RETRACTORS 5MM DIA.- SMALL                                 | <b>52450-01</b> |
| <b>52430-02</b> | ELMED NATHANSON STYLE LIVER RETRACTORS 5MM DIA.- MEDIUM                                | <b>52450-02</b> |
| <b>52430-03</b> | ELMED NATHANSON STYLE LIVER RETRACTORS 5MM DIA.- LARGE                                 | <b>52450-03</b> |
| <b>52430-04</b> | ELMED NATHANSON STYLE LIVER RETRACTORS 5MM DIA.- X-SMALL                               | <b>52450-04</b> |
| <b>52430-05</b> | ELMED NATHANSON STYLE LIVER RETRACTORS 5MM DIA.- X-LARGE                               |                 |
| <b>52460-00</b> | ELMED NATHANSON STYLE LIVER RETRACTORS 3.0MM DIA. SET OF 3 - SIZES: SMALL MEDIUM LARGE | <b>52460-00</b> |
| <b>52460-03</b> | ELMED NATHANSON STYLE LIVER RETRACTORS 3.0MM DIA.- SMALL                               | <b>52460-01</b> |
| <b>52460-04</b> | ELMED NATHANSON STYLE LIVER RETRACTORS 3.0MM DIA.- MEDIUM                              | <b>52460-02</b> |
| <b>52460-05</b> | ELMED NATHANSON STYLE LIVER RETRACTORS 3.0MM DIA.- LARGE                               | <b>52460-03</b> |
| <b>52460-06</b> | ELMED NATHANSON STYLE LIVER RETRACTORS 3.0MM DIA.- X-SMALL                             | <b>52460-04</b> |





# NATHANSON LIVER RETRACTORS



MADE IN THE USA

## COOK STYLE NATHANSON LIVER RETRACTORS\*



## FISCHER STYLE LIVER RETRACTORS



| ITEM NO.        | DESCRIPTION  |
|-----------------|--|
| <b>52420-05</b> | 6.5MM, NATHANSON RETRACTOR-COOK STYLE, LARGE, 75MM   |
| <b>52420-06</b> | 6.5MM, NATHANSON RETRACTOR-COOK STYLE, X-LARGE, 95MM |

| ITEM NO.        | DESCRIPTION                                    |
|-----------------|--|
| <b>52460-01</b> | ELMED FISHER STYLE LIVER RETRACTORS, 5MM DIA.  |
| <b>52460-02</b> | ELMED FISHER STYLE LIVER RETRACTORS, 10MM DIA. |

## SPECULUM RETRACTOR—3 BLADES FOR GALL BLADDER EXTRACTION\*

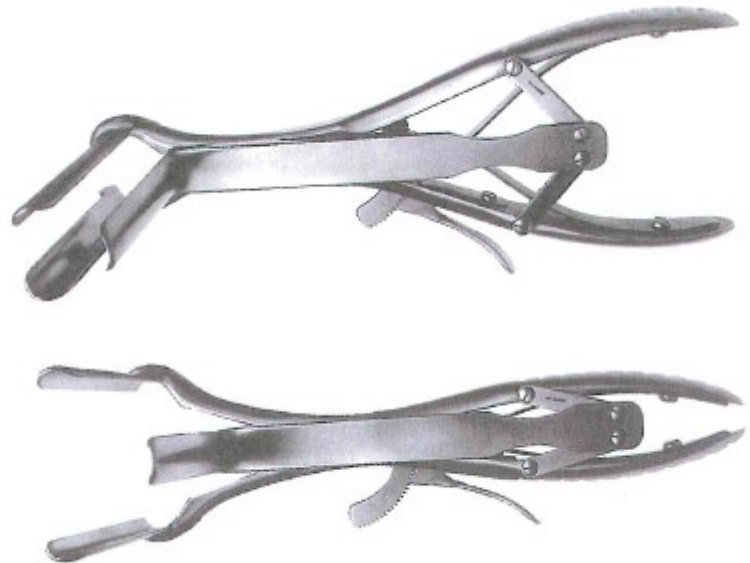
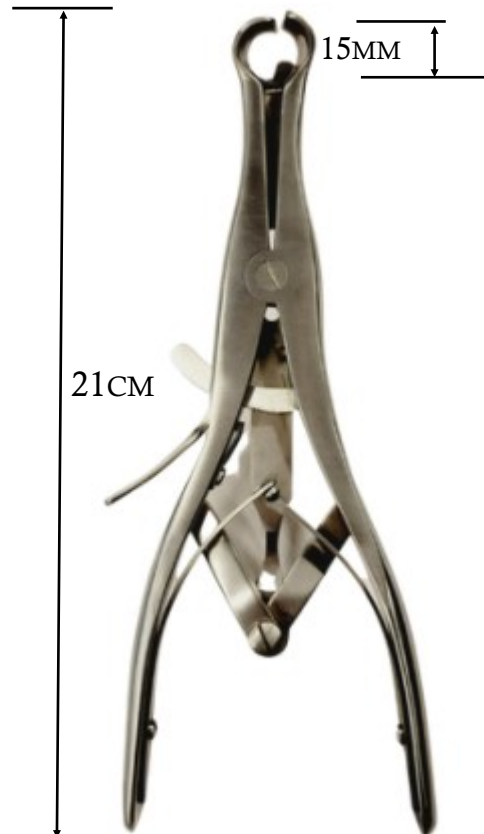

| ITEM NO.        | DESCRIPTION **  |
|-----------------|---|
| <b>52511-00</b> | ELMED SPECULUM RETRACTOR 3-BLADES FOR GALL BLADDER EXTRACTION 15MM DIA. CLOSED 45MM MAX. OPEN FOR USE WITH 11 MM . PLUS TROCAR SLEEVE |





# NATHANSON LIVER RETRACTORS FOR ROBOTIC USE



MADE IN THE USA



| ITEM NO.        | DESCRIPTION   |
|-----------------|---|
| <b>52409-00</b> | SET OF 6.5MM NATHANSON RETRACTORS, ROBOTIC SHAFT 9CM: SMALL, MEDIUM, LARGE  |
| <b>52409-01</b> | SMALL 6.5MM NATHANSON RETRACTOR, ROBOTIC SHAFT 9CM                          |
| <b>52409-02</b> | MEDIUM 6.5MM NATHANSON RETRACTOR, ROBOTIC SHAFT 9CM                         |
| <b>52409-03</b> | LARGE, 6.5MM, ROBOTIC SHAFT 9CM   |
| <b>52409-04</b> | SET OF 5.0MM NATHANSON RETRACTORS, ROBOTIC SHAFT 9CM: SMALL, MEDIUM, LARGE  |
| <b>52409-05</b> | SMALL 5.0MM NATHANSON RETRACTOR, ROBOTIC SHAFT 9CM                          |
| <b>52409-06</b> | MEDIUM 5.0MM NATHANSON RETRACTOR, ROBOTIC SHAFT 9CM                         |
| <b>52409-07</b> | LARGE 5.0MM NATHANSON RETRACTOR, ROBOTIC SHAFT 9CM                          |
| <b>52412-00</b> | SET OF 6.5MM NATHANSON RETRACTORS, ROBOTIC SHAFT 12CM: SMALL, MEDIUM, LARGE |
| <b>52412-01</b> | SMALL 6.5MM NATHANSON RETRACTOR, ROBOTIC SHAFT 12CM                         |
| <b>52412-02</b> | MEDIUM 6.5MM NATHANSON RETRACTOR, ROBOTIC SHAFT 12CM                        |
| <b>52412-03</b> | LARGE 6.5MM NATHANSON RETRACTOR, ROBOTIC SHAFT 12CM                         |
| <b>52450-00</b> | SET OF 5.0MM NATHANSON HOOKS: SMALL, MEDIUM, LARGE                          |
| <b>52450-01</b> | SMALL 5.0MM NATHANSON RETRACTOR   |
| <b>52450-02</b> | MEDIUM 5.0MM NATHANSON RETRACTOR  |
| <b>52450-03</b> | LARGE 5.0MM NATHANSON RETRACTOR   |
| <b>52450-04</b> | EXTRA SMALL 5.0MM NATHANSON RETRACTOR                                       |
| <b>52440-00</b> | SET OF 6.5MM NATHANSON HOOKS: SMALL, MEDIUM, LARGE                          |
| <b>52440-01</b> | SMALL 6.5MM NATHANSON RETRACTOR   |
| <b>52440-02</b> | MEDIUM 6.5MM NATHANSON RETRACTOR  |
| <b>52440-03</b> | LARGE, 6.5MM NATHANSON RETRACTOR, LONG TIP, ROBOTIC SHAFT 9CM               |



TO ORDER CALL: (224) 353-6446



## 90° ARTICULATING FLAT BLADE RETRACTORS



MADE IN THE USA

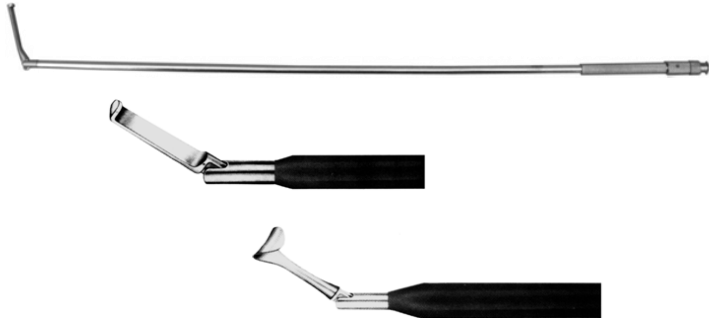

| ITEM NO.        | DESCRIPTION  |
|-----------------|--|
| <b>52505-48</b> | 5MM Ø, 33CM RETRACTOR; 90° ARTICULATING FLAT BLADE, WITH FLUSH PORT            |
| <b>52515-48</b> | 5MM Ø, 45CM RETRACTOR; 90° ARTICULATING FLAT BLADE, WITH FLUSH PORT            |
| <b>52510-87</b> | 10MM Ø, 33CM RETRACTOR; 90° ARTICULATING FLAT BLADE, WITH FLUSH PORT           |
| <b>52511-87</b> | 10MM Ø, 45CM RETRACTOR; 90° ARTICULATING FLAT BLADE, WITH FLUSH PORT           |
| <b>52510-86</b> | 10MM Ø, 33CM RETRACTOR; 90° ARTICULATING "CUSHING"-TYPE BLADE, WITH FLUSH PORT |
| <b>52511-86</b> | 10MM Ø, 45CM RETRACTOR; 90° ARTICULATING "CUSHING"-TYPE BLADE, WITH FLUSH PORT |

## LAP BANDING RETRACTORS



REAR CONTROL KNOB



| ITEM NO.        | DESCRIPTION   |
|-----------------|---|
| <b>52525-21</b> | 5MM DIA., 36CM, ESOPHAGEAL RETRACTOR FOR APPLICATION GASTRIC BANDING 90° ARTICULATING, DISTAL TIP, FLUSH PORT REAR CONTROL KNOB   |
| <b>52515-21</b> | 10MM DIA., 36CM, ESOPHAGEAL RETRACTOR FOR APPLICATION GASTRIC BANDING 90° ARTICULATING, DISTAL TIP, FLUSH PORT REAR CONTROL KNOB  |
| <b>52525-30</b> | 5MM DIA., 41CM, ESOPHAGEAL RETRACTOR FOR APPLICATION GASTRIC BANDING 90° ARTICULATING, DISTAL TIP, FLUSH PORT REAR CONTROL KNOB   |
| <b>52515-30</b> | 10MM DIA., 41CM, ESOPHAGEAL RETRACTOR FOR APPLICATION GASTRIC BANDING 90° ARTICULATING, DISTAL TIP, FLUSH PORT REAR CONTROL KNOB  |
| <b>52525-31</b> | 5MM DIA., 36CM, ESOPHAGEAL RETRACTOR FOR APPLICATION GASTRIC BANDING 90° ARTICULATING, DISTAL TIP, FLUSH PORT FRONT CONTROL KNOB  |
| <b>52515-31</b> | 10MM DIA., 36CM, ESOPHAGEAL RETRACTOR FOR APPLICATION GASTRIC BANDING 90° ARTICULATING, DISTAL TIP, FLUSH PORT FRONT CONTROL KNOB |
| <b>52525-32</b> | 5MM DIA., 41CM, ESOPHAGEAL RETRACTOR FOR APPLICATION GASTRIC BANDING 90° ARTICULATING, DISTAL TIP, FLUSH PORT FRONT CONTROL KNOB  |
| <b>52515-32</b> | 10MM DIA., 41CM, ESOPHAGEAL RETRACTOR FOR APPLICATION GASTRIC BANDING 90° ARTICULATING, DISTAL TIP, FLUSH PORT FRONT CONTROL KNOB |



# LAP BANDING RETRACTORS W/ RATCHET HANDLE



MADE IN THE USA



| ITEM NO.          | DESCRIPTION  | ITEM NO.          | DESCRIPTION   |
|-------------------|--|-------------------|---|
| <b>52525-21A4</b> | 5MM DIA., 36CM, ESOPHAGEAL RETRACTOR-GASTRIC BAND MANIPULATOR, 90°, ANGULATION, WITH RING RATCHET HANDLE, RIGID, ONE PIECE W/FLUSH PORT  | <b>52525-21B4</b> | 5MM DIA., 36CM, ESOPHAGEAL RETRACTOR-GASTRIC BAND MANIPULATOR, 90°, ANGULATION, WITH RING RATCHET HANDLE, ROTATABLE- ONE PIECE W/ FLUSH PORT  |
| <b>52515-21A4</b> | 5MM DIA., 41CM, ESOPHAGEAL RETRACTOR-GASTRIC BAND MANIPULATOR, 90°, ANGULATION, WITH RING RATCHET HANDLE, RIGID, ONE PIECE W/FLUSH PORT  | <b>52515-21B4</b> | 5MM DIA., 41CM, ESOPHAGEAL RETRACTOR-GASTRIC BAND MANIPULATOR, 90°, ANGULATION, WITH RING RATCHET HANDLE, ROTATABLE- ONE PIECE W/ FLUSH PORT  |
| <b>52525-30A4</b> | 10MM DIA., 36CM, ESOPHAGEAL RETRACTOR-GASTRIC BAND MANIPULATOR, 90°, ANGULATION, WITH RING RATCHET HANDLE, RIGID, ONE PIECE W/FLUSH PORT | <b>52525-30B4</b> | 10MM DIA., 36CM, ESOPHAGEAL RETRACTOR-GASTRIC BAND MANIPULATOR, 90°, ANGULATION, WITH RING RATCHET HANDLE, ROTATABLE- ONE PIECE W/ FLUSH PORT |
| <b>52515-30A4</b> | 10MM DIA., 41CM, ESOPHAGEAL RETRACTOR-GASTRIC BAND MANIPULATOR, 90°, ANGULATION, WITH RING RATCHET HANDLE, RIGID, ONE PIECE W/FLUSH PORT | <b>52515-30B4</b> | 10MM DIA., 41CM, ESOPHAGEAL RETRACTOR-GASTRIC BAND MANIPULATOR, 90°, ANGULATION, WITH RING RATCHET HANDLE, ROTATABLE- ONE PIECE W/ FLUSH PORT |



| ITEM NO.           | DESCRIPTION  | ITEM NO.           | DESCRIPTION   |
|--------------------|--|--------------------|---|
| <b>52525-21A12</b> | 5MM DIA., 36CM, ESOPHAGEAL RETRACTOR-GASTRIC BAND MANIPULATOR, 90°, ANGULATION, RING AXIAL HANDLE W/ RATCHET, RIGID, ONE PIECE W/FLUSH PORT  | <b>52525-21B12</b> | 5MM DIA., 36CM, ESOPHAGEAL RETRACTOR-GASTRIC BAND MANIPULATOR, 90°, ANGULATION, RING AXIAL HANDLE W/ RATCHET, ROTATABLE- ONE PIECE W/ FLUSH PORT  |
| <b>52515-21A12</b> | 5MM DIA., 41CM, ESOPHAGEAL RETRACTOR-GASTRIC BAND MANIPULATOR, 90°, ANGULATION, RING AXIAL HANDLE W/ RATCHET, RIGID, ONE PIECE W/FLUSH PORT  | <b>52515-21B12</b> | 5MM DIA., 41CM, ESOPHAGEAL RETRACTOR-GASTRIC BAND MANIPULATOR, 90°, ANGULATION, RING AXIAL HANDLE W/ RATCHET, ROTATABLE- ONE PIECE W/ FLUSH PORT  |
| <b>52525-30A12</b> | 10MM DIA., 36CM, ESOPHAGEAL RETRACTOR-GASTRIC BAND MANIPULATOR, 90°, ANGULATION, RING AXIAL HANDLE W/ RATCHET, RIGID, ONE PIECE W/FLUSH PORT | <b>52525-30B12</b> | 10MM DIA., 36CM, ESOPHAGEAL RETRACTOR-GASTRIC BAND MANIPULATOR, 90°, ANGULATION, RING AXIAL HANDLE W/ RATCHET, ROTATABLE- ONE PIECE W/ FLUSH PORT |
| <b>52515-30A12</b> | 10MM DIA., 41CM, ESOPHAGEAL RETRACTOR-GASTRIC BAND MANIPULATOR, 90°, ANGULATION, RING AXIAL HANDLE W/ RATCHET, RIGID, ONE PIECE W/FLUSH PORT | <b>52515-30B12</b> | 10MM DIA., 41CM, ESOPHAGEAL RETRACTOR-GASTRIC BAND MANIPULATOR, 90°, ANGULATION, RING AXIAL HANDLE W/ RATCHET, ROTATABLE- ONE PIECE W/ FLUSH PORT |





# SNAKE RETRACTORS



MADE IN THE USA



| TIP STYLE | ITEM NO.           | DESCRIPTION  |
|-----------|--------------------|--|
|           | <b>52550-07</b>    | 5MM, 34CM LAPAROSCOPIC RETRACTOR W/ FLEXIBLE, RIGHT ANGLED, FORMABLE TIP               |
|           | <b>52550-05</b>    | 5MM, 34CM LAPAROSCOPIC RETRACTOR W/ FLEXIBLE, TRIANGULAR, FORMABLE TIP                 |
|           | <b>52550-05-45</b> | 5MM, 45CM LAPAROSCOPIC RETRACTOR W/ FLEXIBLE, TRIANGULAR, FORMABLE TIP                 |
|           | <b>52550-06</b>    | 5MM, 34CM LAPAROSCOPIC RETRACTOR W/ FLEXIBLE, TRIANGULAR, RIGHT ANGLED FORMABLE TIP    |
|           | <b>52550-06-45</b> | 5MM, 45CM LAPAROSCOPIC RETRACTOR W/ FLEXIBLE, TRIANGULAR, RIGHT ANGLED FORMABLE TIP    |
|           | <b>52550-08</b>    | 5MM, 34CM LAPAROSCOPIC RETRACTOR W/ FLEXIBLE CIRCULAR TIP, STRAIGHT, 40MM TIP          |
|           | <b>52550-09</b>    | 5MM, 34CM LAPAROSCOPIC RETRACTOR W/ FLEXIBLE CIRCULAR TIP, ANGLED, 40MM TIP            |
|           | <b>52550-10</b>    | 5MM, 34CM LAPAROSCOPIC RETRACTOR, FLEXIBLE TIP, HOOKED, CURVED RIGHT                   |
|           | <b>52550-11</b>    | 5MM, 34CM LAPAROSCOPIC RETRACTOR, FLEXIBLE TIP, HOOKED, CURVED LEFT                    |
|           | <b>52550-12R</b>   | 5MM, 34CM LAPAROSCOPIC RETRACTOR, FLEXIBLE TIP, HOOKED, CURVED RIGHT, ANGLED IN SHEATH |
|           | <b>52550-12L</b>   | 5MM, 34CM LAPAROSCOPIC RETRACTOR, FLEXIBLE TIP, HOOKED, CURVED LEFT, ANGLED IN SHEATH  |
|           | <b>52550-13</b>    | 5MM, 34CM LAPAROSCOPIC RETRACTOR, FLEXIBLE TIP, HOOKED, STRAIGHT, ANGLED IN SHEATH     |





# FAN RETRACTORS



MADE IN THE USA



| ITEM No.        | DESCRIPTION  |
|-----------------|--|
| <b>52505-15</b> | 5MM Ø, 34CM ARTICULATING FAN RETRACTOR/ELEVATOR W/ 3 FLAT, 60° ARTICULATING AND FOLDING BLADES, (60MM MAX WIDTH), ADJUSTABLE HANDLE W/ FLUSHPORT, STAINLESS STEEL  |
| <b>52510-15</b> | 10MM Ø, 34CM ARTICULATING FAN RETRACTOR/ELEVATOR W/ 5 FLAT, 60° ARTICULATING AND FOLDING BLADES, (90MM MAX WIDTH), ADJUSTABLE HANDLE W/ FLUSHPORT, STAINLESS STEEL |
| <b>52525-15</b> | 5MM Ø, 45CM ARTICULATING FAN RETRACTOR/ELEVATOR W/ 3 FLAT, 60° ARTICULATING AND FOLDING BLADES, (60MM MAX WIDTH), ADJUSTABLE HANDLE W/ FLUSHPORT, STAINLESS STEEL  |
| <b>52515-15</b> | 10MM Ø, 45CM ARTICULATING FAN RETRACTOR/ELEVATOR W/ 5 FLAT, 60° ARTICULATING AND FOLDING BLADES, (90MM MAX WIDTH), ADJUSTABLE HANDLE W/ FLUSHPORT, STAINLESS STEEL |

## KITE RETRACTORS

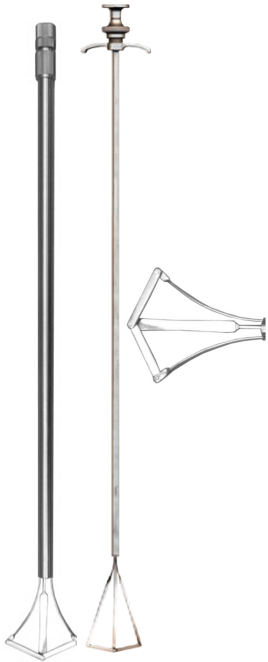

| ITEM No.         | DESCRIPTION   |
|------------------|---|
| <b>52505-50</b>  | 5MM Ø, 33CM RETRACTOR/ELEVATOR CURVED, ROTATABLE, TRIANGULAR KITE-SHAPED BLADE, LOCKING HANDLE    |
| <b>52515-50</b>  | 5MM Ø, 45CM RETRACTOR/ELEVATOR CURVED, ROTATABLE, TRIANGULAR KITE-SHAPED BLADE, LOCKING HANDLE    |
| <b>52505-51</b>  | 5MM Ø, 33CM RETRACTOR/ELEVATOR STRAIGHT, ROTATABLE, TRIANGULAR KITE-SHAPED BLADE, LOCKING HANDLE  |
| <b>52515-51</b>  | 5MM Ø, 45CM RETRACTOR/ELEVATOR STRAIGHT, ROTATABLE, TRIANGULAR KITE-SHAPED BLADE, LOCKING HANDLE  |
| <b>52510-50</b>  | 10MM Ø, 33CM RETRACTOR/ELEVATOR CURVED, ROTATABLE, TRIANGULAR KITE-SHAPED BLADE, LOCKING HANDLE   |
| <b>52511-50</b>  | 10MM Ø, 45CM RETRACTOR/ELEVATOR STRAIGHT, ROTATABLE, TRIANGULAR KITE-SHAPED BLADE, LOCKING HANDLE |
| <b>52505-50T</b> | 5MM Ø, 33CM RETRACTOR/ELEVATOR CURVED, ROTATABLE, TRIANGULAR KITE-SHAPED BLADE, "T"-HANDLE        |
| <b>52515-50T</b> | 5MM Ø, 45CM RETRACTOR/ELEVATOR CURVED, ROTATABLE, TRIANGULAR KITE-SHAPED BLADE, "T"-HANDLE        |
| <b>52505-51T</b> | 5MM Ø, 33CM RETRACTOR/ELEVATOR, STRAIGHT, ROTATABLE, TRIANGULAR KITE-SHAPED BLADE, "T"-HANDLE     |
| <b>52515-51T</b> | 5MM Ø, 45CM RETRACTOR/ELEVATOR, STRAIGHT, ROTATABLE, TRIANGULAR KITE-SHAPED BLADE, "T"-HANDLE     |

## MINIMALLY INVASIVE RETRACTORS/ELEVATORS



**52505-40**

5MM Ø, 33CM RETRACTOR/ELEVATOR 90° ARTICULATING TEFLON TIP, ACCORDING TO DR. VALLE, W/ FLUSH



**52505-51**

5MM Ø, 33CM ELEVATOR/PROBE STRAIGHT, TEFLON TIP, ACCORDING TO DR. VALLE



**52505-39**

5MM Ø, 33CM LEVER/ELEVATOR RETRACTABLE, STRAIGHT, 4-FINGER BLADES, ROTATABLE INSERT

**52515-39**

5MM Ø, 45CM LEVER/ELEVATOR RETRACTABLE, STRAIGHT, 4-FINGER BLADES, ROTATABLE INSERT





*ELECTROSURGICAL  
GENERATORS FOR  
LAPAROSCOPY*



# ESU 400 DIGITAL ELECTROSURGICAL UNIT – FOR LAPAROSCOPY & OTHER MINIMALLY INVASIVE PROCEDURES



MADE IN THE USA

## ADVANCED SAFETY FEATURES:

THE **ESU 400 DIGITAL** IS SPECIFICALLY DESIGNED TO ELIMINATE POTENTIAL HAZARDS DUE TO THE IMPROPER CONNECTION OF THE ACTIVE ELECTRODE ACCESSORIES **BY MAKING THE MONOPOLAR & BIPOLAR CONNECTIONS TOTALLY INCOMPATIBLE**. ON COMPETITIVE ELECTROSURGICAL UNITS, THE 4MM BANANA PLUG CONNECTIONS ARE COMMON BETWEEN THE MONOPOLAR & BIPOLAR OUTPUTS & THUS, IT IS POSSIBLE TO CONNECT A BIPOLAR FORCEPS TO THE MONOPOLAR OUTPUT, WHICH COULD LEAD TO AN EXTREMELY DANGEROUS SITUATION. YET, MANY MANUFACTURERS OF ELECTROSURGICAL EQUIPMENT, WHO CLAIM OPTIMAL SAFETY FEATURES, IGNORE OR OVERLOOK THIS.



ITEM No.  
**5759**

**ELMED ESU 400 DIGITAL:** w/ SMART-MATIC CIRCUIT;  
MONOPOLAR AND BIPOLAR; RETURN ELECTRODE MONITOR  
(REM); COMPATIBLE w/ DUAL-CONTACT PATIENT PLATES

WHEN SAFETY, SIMPLICITY, SERVICE-FREE OPERATION, ALONG w/  
ECONOMICAL PRICING IS YOUR OBJECTIVE, THE **ESU 400 DIGITAL** IS THE  
UNIT FOR YOU

## FEATURES OF THE ESU 400 DIGITAL:

- **SMART-O-MATIC™ CIRCUIT**-OUR AUTOMATIC OUTPUT COMPENSATION CIRCUIT PROVIDES THE DESIRED OUTPUT FOR ALL ELECTRODES OR TISSUE CONDITIONS. THE AUTOMATIC RANGE CONTROL REQUIRES NO READJUSTMENT WITHIN THE SET RANGE.
- **3 GENERATORS, ALL INDIVIDUALLY ADJUSTABLE-**
  - **GENERATOR I:** NON-MODULATED CURRENT FOR SMOOTH CUTTING AND CONTACT COAGULATION. BLEND I MODE PROVIDES CUTTING WITH LIMITED HOMEOSTASIS, BUT MORE PRONOUNCED THAN IN THE “PURE” MODE.
  - **GENERATOR II:** DELIVERS MODULATED, HIGH VOLTAGE CURRENT FOR SPRAY COAGULATION AND FULGURATION. THIS NEW SOLID STATE DESIGN PERMITS MASSIVE, FAST COAGULATION FOR UROLOGICAL, CARDIOVASCULAR AND THORACIC PROCEDURES.
  - **GENERATOR III:** A TOTALLY INDEPENDENT BIPOLAR GENERATOR, WHICH MAY BE UTILIZED AT THE SAME TIME AS THE MONOPOLAR GENERATORS, IF DESIRED. ELMED CONTINUES TO LEAD THE WAY IN BIPOLAR GENERATOR TECHNOLOGY, OFFERING A HAND-SWITCHING MODE BI-COMATIC, OR OPERATION BY CONVENTIONAL FOOT-SWITCH
- **DIGITAL READOUT**-TRUE DIGITAL READOUT FOR OUTPUT POWER IN MODELS EQUIPPED WITH A DIGITAL MONITOR, WHICH ACCURATELY INDICATES THE POWER WHICH WILL BE DELIVERED, CALIBRATED TO A 300 OHM LOAD. EVEN CHANGES IN OUTPUT POWER, WHEN SELECTING THE BLENDED MODES FOR GENERATOR I, ARE REGISTERED ON THIS ADVANCED DIGITAL INDICATOR.
- **SAFETY CIRCUIT**-AUTOMATIC SENSING DEVICE IN THE PATIENT RETURN CIRCUIT DEACTIVATES THE MONOPOLAR GENERATOR IF THE PATIENT PLATE CIRCUIT IS DEFECTIVE. WHEN ONLY THE BIPOLAR GENERATOR IS USED, THE PATIENT PLATE DOES NOT HAVE TO BE UTILIZED.
- **RETURN ELECTRODE MONITOR (REM)**-WHEN TWO-SECTION PATIENT RETURN ELECTRODES ARE DESIRABLE WITH THE REM CIRCUIT, SELECT MODEL No. **5757** AND No. **5759**.





# ESU 400 DIGITAL ELECTROSURGICAL UNIT – FOR LAPAROSCOPY & OTHER MINIMALLY INVASIVE PROCEDURES



MADE IN THE USA

## SUGGESTED OPTIONAL ACCESSORIES:

| ITEM NO.    | DESCRIPTION   |
|-------------|---|
| <b>5047</b> | REUSABLE PATIENT PLATE  |
| <b>5071</b> | CONNECTING CABLE FOR REUSABLE STAINLESS STEEL PATIENT PLATES (#5046 & 5047)         |
| <b>5044</b> | RUBBER RETAINING STRAP FOR REUSABLE PATIENT PLATE                                   |
| <b>5395</b> | SELF-ADHESIVE DISPOSABLE PATIENT PLATE (PKG. 25)                                    |
| <b>5702</b> | PATIENT PLATE CONNECTING CABLE FOR DISPOSABLE PATIENT PLATE                         |
| <b>5999</b> | R.E.M. MODIFICATION W/ ADAPTER. INSTALL CIRCUIT FOR RETURN ELECTRODE MONITOR SYSTEM |
| <b>4755</b> | ELMED EQUIPMENT TROLLEY W/ ONE DRAWER   |
| <b>5706</b> | DOUBLE-PEDAL, EXPLOSION-PROOF FOOT-SWITCH (MONOPOLAR)                               |
| <b>5709</b> | DOUBLE-PEDAL, UL-APPROVED FOOT-SWITCH (MONOPOLAR)                                   |
| <b>5703</b> | SINGLE-PEDAL, WATER-SEALS FOOT-SWITCH (BIPOLAR)                                     |
| <b>5707</b> | SINGLE-PEDAL, UL-APPROVED FOOT-SWITCH (BIPOLAR)                                     |

## TECHNICAL DATA OF THE ELMED ESU 400 DIGITAL:

### OUTPUT POWER:

- **GENERATOR I**, MEASURED AT 300 OHM LOAD NON-MODULATED SINUSOIDAL CURRENT 400 WATTS MODULATED BLEND I CURRENT 150 WATTS MODULATED BLEND II CURRENT 100 WATTS
- **GENERATOR II**, MEASURED AT 300 OHM LOAD MODULATED, HIGH VOLTAGE “COAGULATION” CURRENT 70 WATTS
- **GENERATOR III**, MEASURED AT 100 OHM LOAD NON-MODULATED, LOW VOLTAGE BIPOLAR CURRENT 70 WATTS

**OPERATING FREQUENCY:** 500 KHZ

**DIMENSIONS:** 15.5”W x 12.5”D x 6”H (40CM W x 32CM D x 15CM H)

**WEIGHT:** 14 LBS. (6.5 KG)

**POWER REQUIREMENTS:** 117 VOLTS, 60 HZ, 4 (OTHER POWER REQUIREMENTS UPON REQUEST)

**TECHNICAL DATA FOR WATTAGE, VOLTAGE AND FREQUENCY:** ±20%

**UNIT MEETS LATEST ELECTRICAL SAFETY STANDARDS OF US 544, CSA, NFPA, AND IEC PROPOSED STANDARDS.**





# ELMED LAPAROSCOPIC LBC 50-P DIGITAL BIPOLAR GENERATOR W/ INTEGRATED AMMETER, VISUAL COAGULATION INDICATOR AUTOMATIC SHUT-OFF



MADE IN THE USA

THE MOST PROVEN METHOD OF TUBULAR STERILIZATION IS NOW MORE SIMPLIFIED AND ACCURATE W/ OUR POSITIVE RHEOSTAT BIPOLAR INTENSITY SELECTION W/ DIGITAL DISPLAY



- AUTOMATICALLY DELIVERS THE LOWEST POWER REQUIRED TO ACHIEVE THOROUGH COAGULATION OF TISSUE.
- UTILIZES CUTTING WAVE FORM TO ENSURE PRECISE THROUGH COAGULATION OF TISSUE WITH MINIMAL ADHERENCE TO FORCEPS
- PRECISE PRE-SELECTION OF POWER LIMIT FROM 1-50 WATTS
- ACOUSTIC AND VISUAL SIGNAL WHEN THE GENERATOR IS ACTIVATED
- PROPRIETARY ACOUSTIC AND VISUAL AMMETER ASSISTS IN DETERMINING THE ENDPOINT TO COAGULATION.
- CONTINUITY TEST OF THE GENERATOR, CABLE AND INSTRUMENT SYSTEM CAN BE PERFORMED PRIOR TO PROCEDURE BY CLOSING THE JAWS OF THE FORCEPS AND ACTIVATING THE FOOT SWITCH

**52-5671** ELMED LBC 50-P BIPOLAR COAGULATOR W/ MUSICAL & VISUAL COAGULATION MONITOR & DIGITAL INTENSITY SETTING, FEATURING SMART-O-MATIC™ & INTEGRITY TESTER. (INCL. WATER-SEALED FOOT-SWITCH)

## PRINCIPLE OF OPERATION:

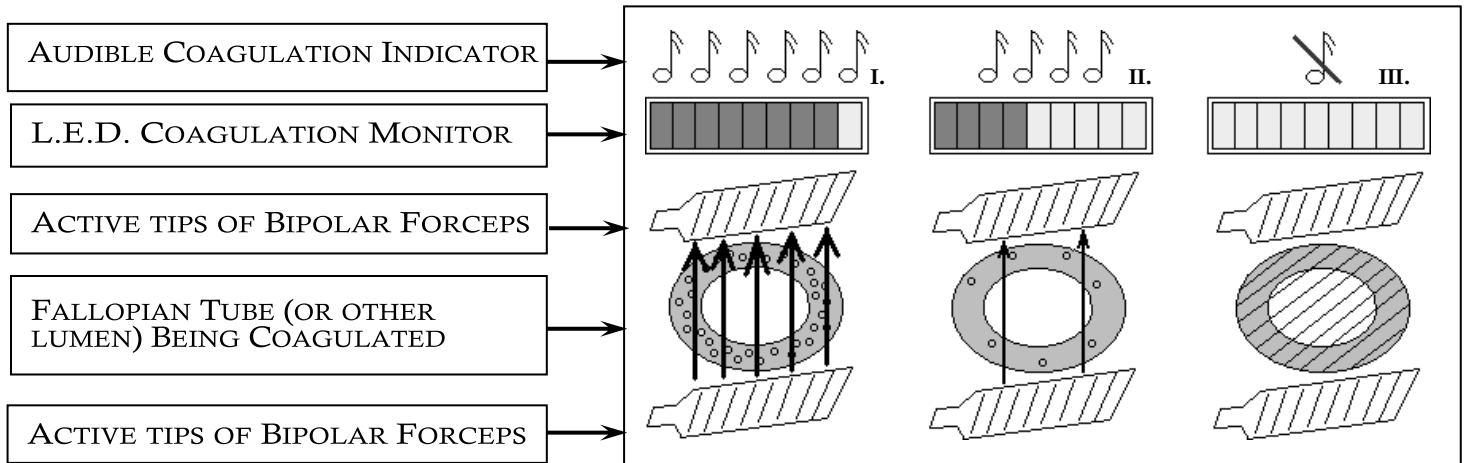

- I. AS THE BIPOLAR GENERATOR IS ACTIVATED, THE RF-CURRENT OF SELECTED INTENSITY FLOWS BETWEEN THE TWO TIPS OF BIPOLAR FORCEPS THROUGH TISSUE OF THE FALLOPIAN TUBE (RR OTHER LUMEN). THE VISUAL L.E.D. DISPLAY INDICATES THE CURRENT FLOW BY THE NUMBER OF BAR GRAPH L.E.D. UNITS LIT UP (IN ACCORDANCE W/ THE SELECTED INTENSITY) AND THE AUDIBLE INDICATOR PRODUCES A HIGH-PITCH UNINTERRUPTED CURRENT FLOW.
- II. AS THE COAGULATED TISSUE BECOMES MORE DEHYDRATED, THUS LESS ELECTRICALLY CONDUCTIVE, THE RF-CURRENT FLOW REDUCES, WHICH IS INDICATED BY THE FEWER LIT UP L.E.D.'S ON THE BAR GRAPH DISPLAY AND BY THE REDUCED IN TONE OF THE AUDIBLE INDICATOR.
- III. ONCE THE TISSUE IS COMPLETELY COAGULATED, IT BECOMES NON-CONDUCTIVE, NO RF-CURRENT CAN GO THROUGH. THE ABSENCE OF RF-CURRENT FLOW IS INDICATED BY NO LIT-UP L.E.D.'S ON THE BAR GRAPH DISPLAY AND THE SILENCE OF THE AUDIBLE INDICATOR. AT THIS MOMENT THE GENERATOR WILL SOUND AN "END TONE" SIGNAL AND THE POWER OUTPUT WILL BE SHUT DOWN; THE FOOT PEDAL MAY BE DEACTIVATED. IT IS IMPORTANT THAT THE SURGICAL SITE IS VISUALLY INSPECTED TO ENSURE COMPLETE COAGULATION. ADDITIONAL COAGULATION APPLICATION MAY BE NEEDED AT ANOTHER SITE ALONG THE FALLOPIAN TUBE TO ENSURE MAXIMUM EFFECTIVENESS.

## TECHNICAL DATA:

**RF OUTPUT:** BIPOLAR ISOLATED (FLOATING) OUTPUT OF EXTREMELY LOW TENSION RF, 50 WATTS AT 100 OHMS (MAX. 360 V), PRECISELY ADJUSTABLE OR PRESET POSITION: 20 WATTS AT 100 OHMS (MAX. 280 V) BOTH DIGITALLY DISPLAYED

**POWER SUPPLY:** 115 V, 60 Hz (OTHER POWER REQUIREMENTS UPON REQUEST)

**DIMENSIONS:** 10" W x 9" D x 5" H (25 CM x 22.8 CM x 12.7 CM)



# ELMED ARFM BIPOLAR LAPAROSCOPIC COAGULATION MONITOR



MADE IN THE USA

THE MOST PROVEN METHOD OF TUBULAR STERILIZATION IS NOW MORE SIMPLIFIED AND ACCURATE W/ OUR POSITIVE RHEOSTAT BIPOLAR INTENSITY SELECTION W/ DIGITAL DISPLAY

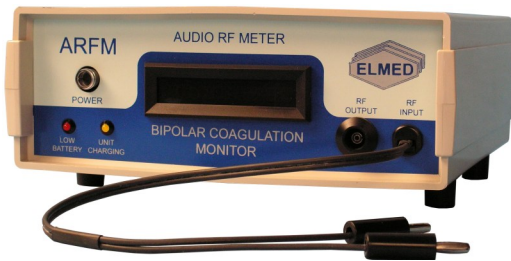

- AUTOMATICALLY DELIVERS THE LOWEST POWER REQUIRED TO ACHIEVE THOROUGH COAGULATION OF TISSUE.
- UTILIZES CUTTING WAVE FORM TO ENSURE PRECISE THROUGH COAGULATION OF TISSUE W/ MINIMAL ADHERENCE TO FORCEPS
- PRECISE PRE-SELECTION OF POWER LIMIT FROM 1-50 WATTS
- ACOUSTIC & VISUAL SIGNAL WHEN THE GENERATOR IS ACTIVATED
- PROPRIETARY ACOUSTIC & VISUAL AMMETER ASSISTS IN DETERMINING THE ENDPOINT TO COAGULATION.
- CONTINUITY TEST OF THE GENERATOR, CABLE & INSTRUMENT SYSTEM CAN BE PERFORMED PRIOR TO PROCEDURE BY CLOSING THE JAWS OF THE FORCEPS & ACTIVATING THE FOOT SWITCH

52-5675 | ELMED AREM LAPAROSCOPIC BIPOLAR COAGULATION MONITOR FOR ELMED OR WOLF GENERATORS

52-5680 | ELMED AREM LAPAROSCOPIC BIPOLAR COAGULATION MONITOR FOR VALLEYLAB, CONMED & OTHER GENERATIONS W/ TWO-BANANA PLUG CONNECTION

### PRINCIPLE OF OPERATION:

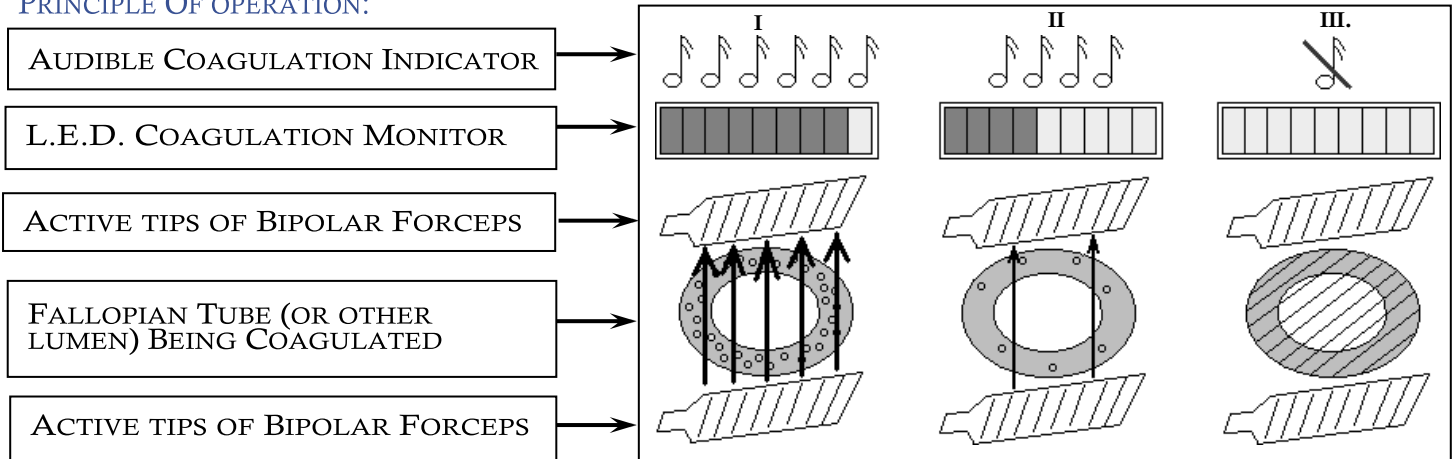

- I. AS THE BIPOLAR GENERATOR IS ACTIVATED, THE RF-CURRENT OF SELECTED INTENSITY FLOWS BETWEEN THE TWO TIPS OF BIPOLAR FORCEPS THROUGH TISSUE OF THE FALLOPIAN TUBE (OR OTHER LUMEN). THE VISUAL L.E.D. DISPLAY INDICATES THE CURRENT FLOW BY THE NUMBER OF BAR GRAPH L.E.D. UNITS LIT UP (IN ACCORDANCE W/ THE SELECTED INTENSITY) AND THE AUDIBLE INDICATOR PRODUCES A HIGH-PITCH SIGNAL (MANUAL VOLUME ADJUSTMENT KNOB ON THE BACK OF THE UNIT) TO CONFIRM THE UNINTERRUPTED CURRENT FLOW.
- II. AS THE COAGULATED TISSUE BECOMES MORE DEHYDRATED, THUS LESS ELECTRICALLY CONDUCTIVE, THE RF-CURRENT FLOW REDUCES, WHICH IS INDICATED BY THE FEWER LIT UP L.E.D.'S ON THE BAR GRAPH DISPLAY & BY THE REDUCED IN TONE OF THE AUDIBLE INDICATOR.
- III. ONCE THE TISSUE IS COMPLETELY COAGULATED, IT BECOMES NON-CONDUCTIVE, NO RF-CURRENT CAN GO THROUGH. THE ABSENCE OF RF-CURRENT FLOW IS INDICATED BY NO LIT-UP L.E.D.'S ON THE BAR GRAPH DISPLAY & THE SILENCE OF THE AUDIBLE INDICATOR. AT THIS MOMENT THE GENERATOR WILL SOUND AN "END TONE" SIGNAL & THE POWER OUTPUT WILL BE SHUT DOWN; THE FOOT PEDAL MAY BE DEACTIVATED. IT IS IMPORTANT THAT THE SURGICAL SITE IS VISUALLY INSPECTED TO ENSURE COMPLETE COAGULATION. ADDITIONAL COAGULATION APPLICATION MAY BE NEEDED AT ANOTHER SITE ALONG THE FALLOPIAN TUBE TO ENSURE MAXIMUM EFFECTIVENESS.

**NOTE:** BECAUSE THE ELMED ARFM BIPOLAR LAPAROSCOPIC COAGULATION MONITOR DOES NOT PRODUCE THE POWER, BUT ONLY MONITORS IT, IT WILL NOT AUTOMATICALLY SHUT OFF THE RF-CURRENT FLOW. THE MONITOR SIGNALS WHEN IT IS TIME TO MANUALLY STOP THE RF-CURRENT FLOW, (DISENGAGE THE BIPOLAR GENERATOR) VIA THE BIPOLAR FORCEPS, BY DEACTIVATING THE FOOTSWITCH. THE MONITOR IS INTENDED TO AID THE SURGEONS TO ENSURE THOROUGH COAGULATION OF THE FALLOPIAN TUBE (OR OTHER LUMENS). VISUAL INSPECTION DURING & AFTER THE COAGULATION OF THE TREATED AREA IS MANDATORY TO CONFIRM THE PROCEDURE HAS BEEN PERFORMED PROPERLY.





# *BIPOLAR LAPAROSCOPIC INSTRUMENTS*

QUALITY, VALUE PRICED REUSABLE AMERICAN MADE SURGICAL INSTRUMENTS BY ELMED.  
WHEN PRECISE ATRAUMATIC COAGULATION IS ESSENTIAL, BIPOLAR COAGULATION FORCEPS  
PLAY AN IMPORTANT ROLE.

**ELMED'S GOAL IS TO PROVIDE YOU WITH THE MOST COST-EFFECTIVE, HIGH QUALITY,  
REUSABLE, VALUE PRICED INSTRUMENT TO HELP YOU  
REDUCE AND CONTROL YOUR SURGICAL PROCEDURE COSTS**



# THE ORIGINAL KLEPPINGER BIPOLAR LAPAROSCOPIC FORCEPS



MADE IN THE USA



SYRINGE-TYPE KLEPPINGER BIPOLAR FORCEPS

| 5MM DIA., 32CM LENGTH |                 | 5MM DIA., 45CM LENGTH |                 |
|-----------------------|-----------------|-----------------------|-----------------|
| ITEM NO.              | DESCRIPTION     | ITEM NO.              | DESCRIPTION     |
| <b>52205-100</b>      | FLAT TIP        | <b>52105-100</b>      | FLAT TIP        |
| <b>52205-100S</b>     | STANDARD TIP    | <b>52105-100S</b>     | STANDARD TIP    |
| <b>52205-100T</b>     | FENESTRATED TIP | <b>52105-100T</b>     | FENESTRATED TIP |
| <b>52205-100M</b>     | MICRO TIP       | <b>52105-100M</b>     | MICRO TIP       |

## BIPOLAR CABLES FOR KLEPPINGER FORCEPS

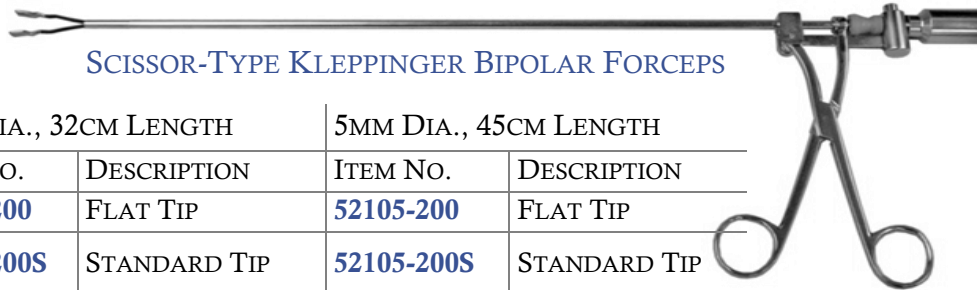

SCISSOR-TYPE KLEPPINGER BIPOLAR FORCEPS

| 5MM DIA., 32CM LENGTH |                 | 5MM DIA., 45CM LENGTH |                 |
|-----------------------|-----------------|-----------------------|-----------------|
| ITEM NO.              | DESCRIPTION     | ITEM NO.              | DESCRIPTION     |
| <b>52205-200</b>      | FLAT TIP        | <b>52105-200</b>      | FLAT TIP        |
| <b>52205-200S</b>     | STANDARD TIP    | <b>52105-200S</b>     | STANDARD TIP    |
| <b>52205-200T</b>     | FENESTRATED TIP | <b>52105-200T</b>     | FENESTRATED TIP |
| <b>52205-200M</b>     | MICRO TIP       | <b>52105-200M</b>     | MICRO TIP       |

## 52005-24

ELMED/ WOLF KLEPPINGER PLUG & DUAL-BANANA GENERATOR PLUG

OR



## 52005-23

ELMED/WOLF KLEPPINGER PLUG & ELMED/WOLF GENERATOR PLUG

## REUSABLE REPLACEMENT TONGS FOR KLEPPINGER TYPE FORCEPS

ALL OF OUR INNER TONGS ARE INTERCHANGEABLE WITH THE ORIGINAL WOLF STYLE

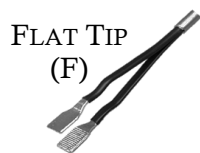

FLAT TIP (F)

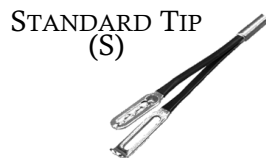

STANDARD TIP (S)

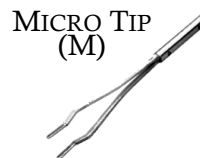

MICRO TIP (M)

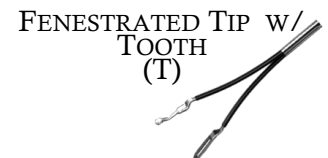

FENESTRATED TIP W/ TOOTH (T)

| ITEM NO.         | DESCRIPTION  |
|------------------|--|
| <b>52205-101</b> | 32CM- FLAT TIP (ORIGINAL KLEPPINGER) INNER TONG - F            |
| <b>52105-101</b> | 45CM - FLAT TIP (ORIGINAL KLEPPINGER) INNER TONG - F           |
| <b>52205-102</b> | 32CM - STD. TIP (FENESTRATED W/ WIRE) - INNER TONG - S         |
| <b>52105-102</b> | 45CM - STD. TIP (FENESTRATED W/ WIRE) - INNER TONG - S         |
| <b>52205-103</b> | 32CM - MICRO TIP (NARROW SHORT TIP) - INNER TONG - M           |
| <b>52105-103</b> | 45CM - MICRO TIP (NARROW SHORT TIP) - INNER TONG - M           |
| <b>52205-104</b> | 32CM - FENESTRATED TIP (FENESTRATED W/ TOOTH) - INNER TONG - T |
| <b>52105-104</b> | 45CM - FENESTRATED TIP (FENESTRATED W/ TOOTH) - INNER TONG - T |

### NOTE:

BOTH THE SYRINGE & SCISSOR HANDLE KLEPPINGER FORCEPS ARE AVAILABLE WITH THE OPTIONAL INNER TONGS. USE THE FIRST NUMBER FROM ABOVE FOR THE INSTRUMENT & ADD THE LETTER OF YOUR CHOICE FOR THE OPTIONAL INSERT S, T, M.

WE ALSO HAVE REUSABLE REPLACEMENT TONGS AVAILABLE FOR STORZ, ACMI, PILLING AND OTHER BRANDS OF BIPOLAR LAPAROSCOPIC FORCEPS





# KLEPPINGER TYPE III BIPOLAR LAPAROSCOPIC FORCEPS



MADE IN THE USA

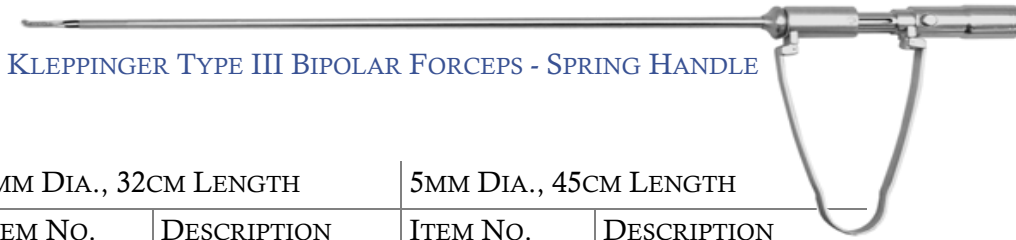

KLEPPINGER TYPE III BIPOLAR FORCEPS - SPRING HANDLE

| 5MM DIA., 32CM LENGTH |             | 5MM DIA., 45CM LENGTH |             |
|-----------------------|-------------|-----------------------|-------------|
| ITEM NO.              | DESCRIPTION | ITEM NO.              | DESCRIPTION |
| <b>52205-85S</b>      | STD. TIP    | <b>52105-67S</b>      | STD. TIP    |
| <b>52205-85F</b>      | FLAT TIP    | <b>52105-67F</b>      | FLAT TIP    |
| <b>52205-85M</b>      | MICRO TIP   | <b>52105-67M</b>      | MICRO TIP   |

## BIPOLAR CABLES FOR USE WITH ELMED TYPE III KLEPPINGER FORCEPS



### 52005-20

ELMED TYPE III KLEPPINGER PLUG & DUAL-BANANA GENERATOR PLUG

**OR**



### 52005-19

ELMED TYPE III KLEPPINGER PLUG & ELMED/WOLF GENERATOR PLUG

## FEATURES:

- MICRO POLISHED TIP
- STATIONARY INNER TONG - IT DOES NOT MOVE IN & OUT WHILE OPENING & CLOSING, GIVING THE SURGEON COMPLETE CONTROL OF PLACEMENT
- NEW TYPE OF CABLE CONNECTOR FOR EASIER CLEANING OF HANDLE & POSITIVE CONNECTION
- INTERCHANGEABLE INNER TONGS
- PRESSURE-LOADED MECHANISM OF THE SPRING HANDLE ASSISTS IN CLOSING OF THE INSTRUMENT

## REUSABLE REPLACEMENT TONGS FOR KLEPPINGER TYPE III

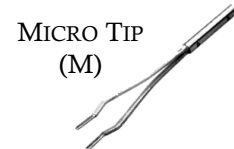
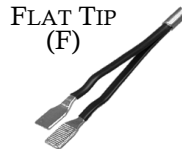
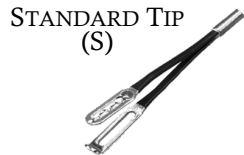

| STD. TIP FOR SECURE SLIP-FREE GRIP |                 | FLAT TIP, CONVENTIONAL KLEPPINGER STYLE |                 | MICRO TIP FOR PRECISE, PIN-POINT COAGULATION |                 |
|------------------------------------|-----------------|---|-----------------|--|-----------------|
| 32CM                               | 45CM            | 32CM                                    | 45CM            | 32CM   | 45CM            |
| <b>52205-44</b>                    | <b>52105-70</b> | <b>52205-91</b>                         | <b>52105-71</b> | <b>52205-47</b>                              | <b>52105-72</b> |

## NOTE:

WHEN ORDERING REPLACEMENT TONGS FOR ELMED SLIDE HANDLE BIPOLAR FORCEPS WITH A SINGLE TUBE OR WITH IRRIGATION TUBE, ADD LETTERS "ST" TO THE ABOVE LIST NUMBERS (THE PRICE REMAINS THE SAME). FOR HANDLE REPLACEMENT PARTS FOR ALL ELMED LAPAROSCOPIC BIPOLAR FORCEPS REFER TO THE OPERATING INSTRUCTIONS.





# POWERGRIP BIPOLAR SCISSORS & FORCEPS



MADE IN THE USA



## FEATURES:

- THE BIPOLAR POWERGRIP COAGULATION FORCEPS IS AN INSTRUMENT USED FOR GRASPING, CUTTING AND BIPOLAR COAGULATION IN MINIMALLY INVASIVE SURGERY. THEIR MECHANISM ENABLES ACTIVE AND PRECISE OPENING AND CLOSING OF THE JAWS AS WELL AS APPLYING VERY HIGH PRESSURE WHEN GRASPING AND CUTTING WHILE PRECISELY COAGULATING THE TISSUE. ELECTRODE INSERTS FOR DIFFERENT APPLICATIONS CAN BE EXCHANGED WITHIN A FEW SECONDS
- 3-PIECE TAKE APART FOR EFFICIENT CLEANING AND INTERCHANGE OF INSERTS.
- THE PLUG FOR STANDARDIZED BIPOLAR CABLES, WHICH ENABLES THE CONNECTION TO NEARLY ALL COMMON HIGH FREQUENCY GENERATORS, IS INTEGRATED IN THE PARTICULARLY ERGONOMIC HANDLE.
- REUSABLE INSTRUMENT AND BIPOLAR CABLE FOR COST CONTAINMENT.



**52205-510** | 5MM, 34CM SCISSORS, CURVED



**52205-521** | 5MM, 34CM LARGE GRASPING FORCEPS



**52205-524** | 5MM, 34CM CLAW FORCEPS



**52205-516** | 5MM, 34CM MARYLAND DISSECTOR, CURVED



**52205-522** | 5MM, 34CM FORCEPS, CURVED



**52205-520** | 5MM, 34CM GRASPING FORCEPS, CURVED



**52205-523** | 5MM, 34CM DELTA GRASPER

## BIPOLAR CABLES FOR USE WITH ELMED BIPOLAR POWERGRIP FORCEPS & SCISSORS



**52005-22**  
ELMED TYPE II KLEPPINGER PLUG & DUAL-BANANA GENERATOR PLUG

OR



**52005-21**  
ELMED TYPE II KLEPPINGER PLUG & ELMED/WOLF GENERATOR PLUG





# 360° ROTATABLE ORBITARIS BIPOLAR



MADE IN THE USA

## FEATURES:

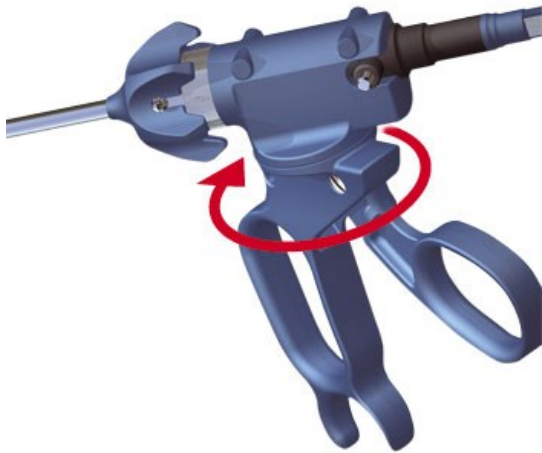

- THE HANDLE CAN BE ROTATED THROUGH 360°, SO THE SURGEONS IDEAL ERGONOMIC HANDLING POSITION CAN BE ACHIEVED. THE SURGEON AND PATIENT REQUIREMENT FOR FUNCTION AND SAFETY HAS BEEN GREATLY ENHANCED, OVER STANDARD HANDLES, TO INCLUDE SURGEON COMFORT DURING THE DEMANDS OF MINIMALLY INVASIVE SURGERY.
- 3-PIECE TAKE APART FOR EFFICIENT CLEANING AND INTERCHANGE OF INSERTS.
- THE PLUG FOR STANDARDIZED BIPOLAR CABLES, WHICH ENABLES THE CONNECTION TO NEARLY ALL COMMON HIGH FREQUENCY GENERATORS, IS INTEGRATED IN THE PARTICULARLY ERGONOMIC HANDLE.
- REUSABLE INSTRUMENT AND BIPOLAR CABLE FOR COST CONTAINMENT.



**52205-010**

5MM, 34CM SCISSORS, CURVED



**52205-021**

5MM, 34CM LARGE GRASPING FORCEPS



**52205-016**

5MM, 34CM MARYLAND DISSECTOR, CURVED



**52205-022**

5MM, 34CM FORCEPS, CURVED, FENESTRATED



**52205-024**

5MM, 34CM GRASPING FORCEPS W/ 2X3 TEETH



**52205-023**

5MM, 34CM TOUCAN GRASPING FORCEPS

## BIPOLAR CABLES FOR USE WITH ELMED BIPOLAR POWERGRIP FORCEPS & SCISSORS



**52005-22**

ELMED TYPE II KLEPPINGER PLUG & DUAL-BANANA GENERATOR PLUG

**OR**



**52005-21**

ELMED TYPE II KLEPPINGER PLUG & ELMED/WOLF GENERATOR PLUG





# POWERGRIP 3.0MM BIPOLAR DISSECTOR & GRASPER



MADE IN THE USA



### FEATURES:

- POWERGRIP 3.0 MICRO - BIPOLAR COAGULATION FORCEPS 0 3MM OFFER ALL BENEFITS OF THE TRIED AND TESTED POWERGRIP COAGULATION PLIERS, BUT ENTICE WITH THEIR SHAFT DIAMETER OF ONLY 3 MM
- 3-PIECE TAKE APART FOR EFFICIENT CLEANING AND INTERCHANGE OF INSERTS.
- THE PLUG FOR STANDARDIZED BIPOLAR CABLES, WHICH ENABLES THE CONNECTION TO NEARLY ALL COMMON HIGH FREQUENCY GENERATORS, IS INTEGRATED IN THE PARTICULARLY ERGONOMIC HANDLE.
- REUSABLE INSTRUMENT AND BIPOLAR CABLE FOR COST CONTAINMENT.

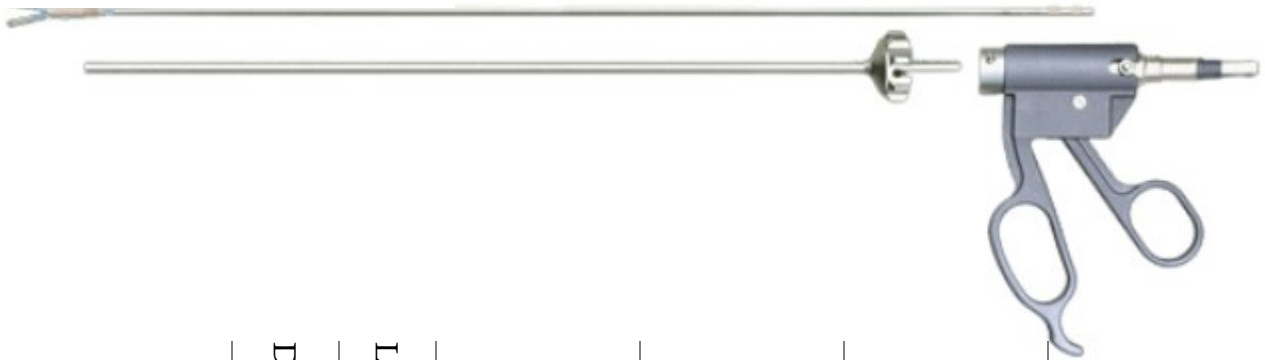

| TIP ID  | DIAMETER | LENGTH | INSERT NO. | HANDLE NO. | SHAFT NO. | COMPLETE INSTRUMENT |
|---|----------|--------|------------|------------|-----------|---------------------|
| MARYLAND DISSECTOR, CURVED  | 3MM      | 20CM   | 53020-322I | 52203-152  | 52203-204 | 53020-322           |
|  | 3MM      | 29CM   | 53029-302I | 52203-152  | 52203-202 | 53029-302           |
| FENESTRATED GRASPING FORCEPS  | 3MM      | 20CM   | 53020-320I | 52203-152  | 52203-204 | 53020-320           |
|  | 3MM      | 29CM   | 53029-300I | 52203-152  | 52203-202 | 53029-300           |

### BIPOLAR CABLES FOR USE WITH ELMED BIPOLAR DISSECTOR & GRASPER



**OR**



**52005-22**

ELMED TYPE II KLEPPINGER PLUG & DUAL-BANANA GENERATOR PLUG

**52005-21**

ELMED TYPE II KLEPPINGER PLUG & ELMED/WOLF GENERATOR PLUG





# CLASSIC BIPOLAR SCISSORS & FORCEPS





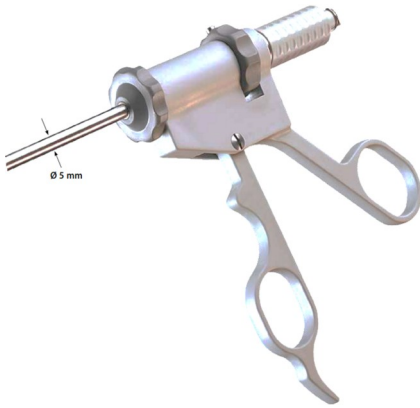



MADE IN THE USA



## FEATURES:

- THE BIPOLAR COAGULATION FORCEPS WHICH CAN BE DISMANTLED IS A REUSABLE INSTRUMENT TO BE USED FOR LAPAROSCOPY FOR GRASPING AND CUTTING THE TISSUE WITH SIMULTANEOUS BIPOLAR COAGULATION. THE EASY DISMANTLING ENABLES THE USE OF DIFFERENT ELECTRODES, FACILITATES CLEANING AND THE EXECUTION OF REPAIR WORK. BY USING AN ADAPTER, THE FORCEPS CAN BE CONNECTED WITH BIPOLAR STANDARD FORCEPS CABLES TO NEARLY ALL COMMON HIGH-FREQUENCY GENERATORS.
- 3-PIECE TAKE APART FOR EFFICIENT CLEANING AND INTERCHANGE OF INSERTS.
- THE PLUG FOR STANDARDIZED BIPOLAR CABLES, WHICH ENABLES THE CONNECTION TO NEARLY ALL COMMON HIGH FREQUENCY GENERATORS, IS INTEGRATED IN THE PARTICULARLY ERGONOMIC HANDLE.
- REUSABLE INSTRUMENT AND BIPOLAR CABLE FOR COST CONTAINMENT.

| ELECTRODES  | DIA. | LENGTH | INSERT NO. | HANDLE NO. | INTERIOR TUBE | EXTERIOR TUBE | DIN PLUG  | COMPLETE INSTR. |
|---|------|--------|------------|------------|---------------|---------------|-----------|-----------------|
| FENESTRATED GRASPER W/ WAVE<br>   | 5MM  | 20CM   | 55020-060I | 52000-001  | 55020-051     | 55020-052     | 52000-401 | 55020-060       |
|   | 5MM  | 34CM   | 55034-010I |            | 55034-002     | 55034-003     |           | 55034-010       |
|   | 5MM  | 45CM   | 55045-020I |            | 55045-006     | 55045-007     |           | 55045-020       |
| FLUTED TIP, 1MM<br>             | 5MM  | 20CM   | 55020-061I | 52000-001  | 55020-051     | 55020-052     | 52000-401 | 55020-061       |
|   | 5MM  | 34CM   | 55034-011I |            | 55034-002     | 55034-003     |           | 55034-011       |
|   | 5MM  | 45CM   | 55045-021I |            | 55045-006     | 55045-007     |           | 55045-021       |
| KLEPPINGER, SERRATED<br>        | 5MM  | 20CM   | 55020-063I | 52000-001  | 55020-051     | 55020-052     | 52000-401 | 55020-063       |
|   | 5MM  | 34CM   | 55034-013I |            | 55034-002     | 55034-003     |           | 55034-013       |
|   | 5MM  | 45CM   | 55045-023I |            | 55045-006     | 55045-007     |           | 55045-023       |
| TONG-TYPE BIT, 3MM<br>          | 5MM  | 20CM   | 55020-065I | 52000-001  | 55020-051     | 55020-052     | 52000-401 | 55020-065       |
|   | 5MM  | 34CM   | 55034-015I |            | 55034-002     | 55034-003     |           | 55034-015       |
|   | 5MM  | 45CM   | 55045-025I |            | 55045-006     | 55045-007     |           | 55045-025       |
| SCISSORS, CURVED<br>            | 5MM  | 20CM   | 55020-067I | 52000-001  | 55020-051     | 55020-052     | 52000-401 | 55020-067       |
|   | 5MM  | 34CM   | 55034-017I |            | 55034-002     | 55034-003     |           | 55034-017       |
|   | 5MM  | 45CM   | 55045-027I |            | 55045-006     | 55045-007     |           | 55045-027       |
| SCISSORS W/ TC BLADE CURVED<br> | 5MM  | 20CM   | 55020-068I | 52000-001  | 55020-051     | 55020-052     | 52000-401 | 55020-068       |
|   | 5MM  | 34CM   | 55034-018I |            | 55034-002     | 55034-003     |           | 55034-018       |
|   | 5MM  | 45CM   | 55045-028I |            | 55045-006     | 55045-007     |           | 55045-028       |
| MARYLAND DISSECTOR, CURVED<br>  | 5MM  | 20CM   | 55020-069I | 52000-001  | 55020-051     | 55020-052     | 52000-401 | 55020-069       |
|   | 5MM  | 34CM   | 55034-019I |            | 55034-002     | 55034-003     |           | 55034-019       |
|   | 5MM  | 45CM   | 55045-029I |            | 55045-006     | 55045-007     |           | 55045-029       |

## BIPOLAR CABLES FOR USE WITH ELMED BIPOLAR DISSECTOR & GRASPER

### 52005-45

ELMED TYPE II KLEPPINGER PLUG & DUAL-BANANA GENERATOR PLUG

### 52005-46

ELMED TYPE II KLEPPINGER PLUG & ELMED/WOLF GENERATOR PLUG



# ELMED TRIPLE FUNCTION FORCEPS SCISSORS & FORCEPS



MADE IN THE USA

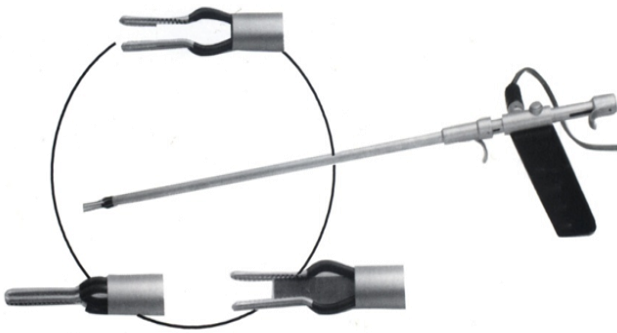

**THE MOST EFFECTIVE MULTIPURPOSE INSTRUMENT OF ITS KIND, WITH FEATURES SUCH AS:**

- **MULTIPLE FUNCTIONS** - SECURELY GRASP/DISSECT TISSUE/ SAFELY COAGULATE IN THE BIPOLAR MODE/ TRANSECT TISSUE/RETRACT TISSUE
- **REUSABILITY** - EASY, COST EFFECTIVE CLEANING & MAINTENANCE
- ELIMINATING COSTLY STAPLING DEVICES
- ONE INSTRUMENT, ONE INSERTION
- REDUCING PROCEDURE TIME

## BIPOLAR CABLES FOR USE WITH ELMED BIPOLAR TRIPLE FUNCTION FORCEPS

| ITEM NO.    | DESCRIPTION   |
|-------------|---|
| 52510-00    | ELMED BIPOLAR TRIPLE FUNCTION FORCEPS: 30CM LONG, 10 MM |
| 52510-00-01 | COMPLETE INNER SHAFT ASSEMBLY W/ BLADE                  |
| 52510-00-02 | BLADE ASSEMBLY FOR TRIPLE FUNCTION FORCEPS              |

| ITEM NO. | DESCRIPTION  |
|----------|--|
| 52005-80 | BIPOLAR RF-CABLE FOR BIPOLAR TRIPLE FUNCTION FORCEPS & ELMED/WOLF GENERATORS                 |
| 52005-81 | BIPOLAR RF-CABLE FOR BIPOLAR TRIPLE FUNCTION FORCEPS & MACHINE W/ TWO BANANA-PLUG CONNECTION |

## ELMED BIPOLAR COAGULATION PROBES

Front (Distal) View, Enlarged



Side View (Actual Size)



| ITEM NO. | DESCRIPTION                              |
|----------|--|
| 52103-35 | 3MM, 33CM BIPOLAR SPOT COAGULATION PROBE |
| 52203-35 | 3MM, 45CM BIPOLAR SPOT COAGULATION PROBE |
| 52205-42 | 5MM, 33CM BIPOLAR SPOT COAGULATION PROBE |
| 52105-37 | 5MM, 45CM BIPOLAR SPOT COAGULATION PROBE |

| ITEM NO. | DESCRIPTION  |
|----------|--|
| 52005-99 | 5MM, 33CM BIPOLAR MYOMA COAGULATOR                   |
| 52005-98 | 5MM, 45CM BIPOLAR MYOMA COAGULATOR                   |
| 52005-97 | 5MM, 33CM BIPOLAR MYOMA COAGULATOR, W/ TRUMPET VALVE |
| 52005-96 | 5MM, 45CM BIPOLAR MYOMA COAGULATOR, W/ TRUMPET VALVE |

### ITEM NO. | DESCRIPTION

52205-92 | 5MM, 33CM BIPOLAR PROBE, TWO BLUNT PRONGS

52205-93 | 5MM, 33CM BIPOLAR PROBE, TWO BLUNT PRONGS W/ TRUMPET VALVE

Side View (Actual Size)

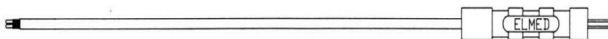

## BIPOLAR CABLES FOR USE WITH ELMED BIPOLAR COAGULATION PROBES



52005-22

ELMED TYPE II KLEPPINGER PLUG & DUAL-BANANA GENERATOR PLUG

**OR**



52005-21

ELMED TYPE II KLEPPINGER PLUG & ELMED/WOLF GENERATOR PLUG









# 5MM LAPAROSCOPIC BIPOLAR ELECTRODES





MADE IN THE USA





| TIP STYLE   | ITEM NO.           | DESCRIPTION                         |
|---|--------------------|-------------------------------------|
|  | <b>52-0534-100</b> | 5MM, 34CM BIPOLAR J-HOOK ELECTRODE  |
|  | <b>52-0534-200</b> | 5MM, 34CM BIPOLAR L-HOOK ELECTRODE  |
|  | <b>52-0534-300</b> | 5MM, 34CM BIPOLAR SPATULA ELECTRODE |
|  | <b>52-0534-400</b> | 5MM, 34CM BIPOLAR DOME ELECTRODE    |

## 3MM LAPAROSCOPIC BIPOLAR ELECTRODES



| TIP STYLE   | ITEM NO.           | DESCRIPTION                        |
|---|--------------------|------------------------------------|
|  | <b>52-0334-200</b> | 3MM, 34CM BIPOLAR L-HOOK ELECTRODE |
|  | <b>52-0334-700</b> | 3MM, 34CM BIPOLAR V-HOOK ELECTRODE |
|  | <b>52-0334-600</b> | 3MM, 34CM BIPOLAR NEEDLE ELECTRODE |



| TIP STYLE   | ITEM NO.           | DESCRIPTION                        |
|---|--------------------|------------------------------------|
|  | <b>52-0330-201</b> | 3MM, 30CM BIPOLAR L-HOOK ELECTRODE |
|  | <b>52-0530-301</b> | 5MM, 30CM BIPOLAR L-HOOK ELECTRODE |

## BIPOLAR CABLES FOR USE WITH ELMED BIPOLAR COAGULATION PROBES



OR



**52005-22**

ELMED TYPE II KLEPPINGER PLUG & DUAL-BANANA GENERATOR PLUG

**52005-21**

ELMED TYPE II KLEPPINGER PLUG & ELMED/WOLF GENERATOR PLUG



# REUSABLE CABLES FOR BIPOLAR INSTRUMENTS & GENERATORS



MADE IN THE USA



ELMED/WOLF GENERATOR END



DUAL-BANANA PLUG GENERATOR END

INSTRUMENT END

| ITEM NO.             | DESCRIPTION   |
|----------------------|---|
| <b>52005-21/5302</b> | ELMED/WOLF PLUG (UNIT) & ELMED (DIN) INST. PLUG                 |
| <b>52005-19</b>      | ELMED/WOLF PLUG (UNIT) & ELMED TYPE III INST. PLUG              |
| <b>52005-23</b>      | ELMED/WOLF UNIT PLUG & WOLF INST. PLUG                          |
| <b>52005-25</b>      | ELMED/WOLF PLUG (UNIT) & STORZ/WISAP/JARIT METAL INST. PLUG     |
| <b>52005-17</b>      | ELMED/WOLF PLUG (UNIT) & STORZ/WISAP BARREL STYLE INST. PLUG    |
| <b>52005-39</b>      | ELMED/WOLF PLUG (UNIT) & KLI/CIRCON INST. PLUG                  |
| <b>52005-41</b>      | ELMED/WOLF PLUG (UNIT) & EVEREST/COBALT INST. PLUG              |
| <b>52005-43</b>      | ELMED/WOLF PLUG (UNIT) & DAVOL INST. PLUG                       |
| <b>52005-45/5991</b> | ELMED/WOLF PLUG (UNIT) & AESCULAP/DAVOL/MARINA 2-PIN INST. PLUG |
| <b>52005-60</b>      | ELMED/WOLF PLUG (UNIT) & LINVATEC/WECK/PILLING INST. PLUG       |
| <b>52005-91</b>      | ELMED/WOLF PLUG (UNIT) & JARIT, ERBE INST. PLUG                 |
| <b>5950-13</b>       | ELMED/WOLF PLUG (UNIT) & ELMED BI-CUT SCISSORS                  |



| ITEM NO.              | DESCRIPTION  |
|-----------------------|--|
| <b>52005-22/5230</b>  | DUAL-BANANA PLUG (UNIT) & ELMED (DIN) INST. PLUG                 |
| <b>52005-20</b>       | DUAL-BANANA PLUG (UNIT) & ELMED TYPE III INST. PLUG              |
| <b>52005-24</b>       | DUAL-BANANA PLUG (UNIT) & WOLF INST. PLUG                        |
| <b>52005-26</b>       | DUAL-BANANA PLUG (UNIT) & STORZ/WISAP/JARIT METAL PLUG           |
| <b>52005-18</b>       | DUAL-BANANA PLUG (UNIT) & STORZ/WISAP BARREL STYLE INST. PLUG    |
| <b>52005-40</b>       | DUAL-BANANA PLUG (UNIT) & KLI/CIRCON INST. PLUG                  |
| <b>52005-42</b>       | DUAL-BANANA PLUG (UNIT) & EVEREST/COBALT INST. PLUG              |
| <b>52005-44</b>       | DUAL-BANANA PLUG (UNIT) & DAVOL INST. PLUG                       |
| <b>52005-46 /5990</b> | DUAL-BANANA PLUG (UNIT) & AESCULAP/DAVOL/MARINA 2-PIN INST. PLUG |
| <b>52005-61</b>       | DUAL-BANANA PLUG (UNIT) & LINAVEC/WECK/PILLING INST. PLUG        |
| <b>52005-92</b>       | DUAL-BANANA PLUG (UNIT) & JARIT, ERBE INST. PLUG                 |
| <b>5950-14</b>        | DUAL-BANANA PLUG (UNIT) & ELMED BI-CUT SCISSORS                  |

## BIPOLAR CABLE ADAPTERS



**5352**

ADAPTER FOR ELMED / WOLF GENERATOR PLUG & 4MM FEMALE BANANA CABLE PLUGS



**52005-83**

ADAPTER FOR DUAL MALE BANANA GENERATOR PLUGS & ELMED / WOLF RECEPTACLE PLUG



**52005-84**

ADAPTER FOR DUAL MALE BANANA GENERATOR PLUG & WOLF KLEPPINGER FORCEPS PLUG



# *MONOPOLAR LAPAROSCOPIC INSTRUMENTS*

SUCCESSFUL AND PRECISE MONOPOLAR SURGICAL TECHNIQUES DEPEND ON PROPERLY DESIGNED AND MADE INSTRUMENTS. *ELMED* HAS BEEN A LEADER IN THE DEVELOPMENT, DESIGN AND MANUFACTURING OF THE FINEST REUSABLE ELECTROSURGICAL EQUIPMENT AND ACCESSORIES.

*ELMED* HAS BEEN SETTING THE PACE IN REUSABLE MONOPOLAR ELECTROSURGICAL TECHNOLOGY FOR NEARLY HALF A CENTURY.













# 5MM DIAMETER MONOPOLAR ELECTRODES



MADE IN THE USA

33CM, 36CM OR 45CM  
SHAFT LENGTH

| ELECTRODES   | DIA. | LENGTH | SIDE MOUNTED RF CONNECTOR   |  | REAR MOUNTED RF CONNECTOR   |  |
|--|------|--------|---|--|---|--|
|  |      |        |  |  |  |  |
| <b>J-HOOK</b><br>   | 5MM  | 33CM   | <b>52205-38</b>   |  | <b>52205-81</b>   |  |
|  | 5MM  | 36CM   | <b>52236-38</b>   |  | <b>52236-81</b>   |  |
|  | 5MM  | 45CM   | <b>52105-33</b>   |  | <b>52105-81</b>   |  |
| <b>L-HOOK</b><br>   | 5MM  | 33CM   | <b>52205-78</b>   |  | <b>52205-82</b>   |  |
|  | 5MM  | 36CM   | <b>52236-78</b>   |  | <b>52236-82</b>   |  |
|  | 5MM  | 45CM   | <b>52105-46</b>   |  | <b>52105-82</b>   |  |
| <b>SPATULA</b><br>  | 5MM  | 33CM   | <b>52205-56</b>   |  | <b>52205-83</b>   |  |
|  | 5MM  | 36CM   | <b>52236-56</b>   |  | <b>52236-83</b>   |  |
|  | 5MM  | 45CM   | <b>52105-46</b>   |  | <b>52105-83</b>   |  |
| <b>CONE</b><br>   | 5MM  | 33CM   | <b>52205-36</b>   |  | <b>52205-88</b>   |  |
|  | 5MM  | 36CM   | <b>52236-36</b>   |  | <b>52236-88</b>   |  |
|  | 5MM  | 45CM   | <b>52105-31</b>   |  | <b>52105-88</b>   |  |
| <b>BALL</b><br>   | 5MM  | 33CM   | <b>52205-07</b>   |  | <b>52205-89</b>   |  |
|  | 5MM  | 36CM   | <b>52236-07</b>   |  | <b>52269-89</b>   |  |
|  | 5MM  | 45CM   | <b>52105-07</b>   |  | <b>52105-89</b>   |  |
| <b>KNIFE</b><br>  | 5MM  | 33CM   | <b>52205-35</b>   |  | <b>52205-90</b>   |  |
|  | 5MM  | 36CM   | <b>52236-35</b>   |  | <b>52236-90</b>   |  |
|  | 5MM  | 45CM   | <b>52105-30</b>   |  | <b>52105-90</b>   |  |
| <b>NEEDLE</b><br> | 5MM  | 33CM   | <b>52205-34</b>   |  | <b>52205-76</b>   |  |
|  | 5MM  | 36CM   | <b>52236-37</b>   |  | <b>52236-76</b>   |  |
|  | 5MM  | 45CM   | <b>52105-45</b>   |  | <b>52105-74</b>   |  |
| <b>BUTTON</b><br> | 5MM  | 33CM   | <b>52205-37</b>   |  | <b>52205-37R</b>  |  |
|  | 5MM  | 36CM   | <b>52236-37R</b>  |  | <b>52236-37R</b>  |  |
|  | 5MM  | 45CM   | <b>52205-02R</b>  |  | <b>52105-02R</b>  |  |

## MONOPOLAR CABLES FOR USE WITH ELECTRODES



### 52005-31

4MM DIA. PLUG (UNIT) & 4MM DIA. FEMALE INST. PLUG



### 52005-32

8MM DIA. "BOVIE" PLUG (UNIT) & 4MM DIA. FEMALE INST. PLUG













# 5MM DIAMETER MONOPOLAR ELECTRODES- WITH SUCTION/IRRIGATION PORT



MADE IN THE USA

32CM OR 45CM  
SHAFT LENGTH



| HANDLE STYLES   | DIA. | LENGTH | J-HOOK  | L-HOOK  | SPATULA   | CONE   | SLING   | KNIFE   | NEEDLE  | SUCTION   |
|---|------|--------|---|---|---|--|---|---|---|---|
|   |      |        |  |  |  |  |  |  |  |  |
|   | 5MM  | 33CM   | 52205-57L   | 52205-72L   | 52205-58L   | 52205-77L  | 52205-66L   | 52205-65L   | 52205-74L   | 52205-28L   |
|   | 5MM  | 36CM   | 52236-57L   | 52236-72L   | 52236-58L   | 52236-77L  | 52236-66L   | 52236-65L   | 52236-74L   | 52236-28L   |
|   | 5MM  | 45CM   | 52105-48L   | 52105-56L   | 52105-58L   | 52105-77L  | 52105-66L   | 52105-47L   | 52105-74L   | 52105-28L   |
|   | 5MM  | 33CM   | 52205-57  | 52205-72  | 52205-58  | 52205-77   | 52205-66  | 52205-65  | 52205-74S   | 52205-27  |
|   | 5MM  | 36CM   | 52236-57  | 52236-72  | 52236-58  | 52236-77   | 52236-66  | 52236-65  | 52236-74S   | 52236-27  |
|   | 5MM  | 45CM   | 52105-48  | 52105-56  | 52105-58  | 52105-77   | 52105-66  | 52105-47  | 52105-74S   | 52105-24  |
|  | 5MM  | 33CM   | 52205-63  | 52205-73  | 52205-64  | 52205-84   | 52205-68  | 52205-67  | 52205-74T   | 52205-26  |
|   | 5MM  | 36CM   | 52236-63  | 52236-73  | 52236-64  | 52236-84   | 52236-68  | 52236-57  | 52236-74T   | 52236-26  |
|   | 5MM  | 45CM   | 52105-54  | 52105-57  | 52105-50  | 52105-60   | 52105-52  | 52105-51  | 52105-74T   | 52105-23  |



## MONOPOLAR CABLES FOR USE WITH ELECTRODES



52005-31

4MM DIA. PLUG (UNIT) & 4MM DIA. FEMALE INST. PLUG

52005-32

8MM DIA. "BOVIE" PLUG (UNIT) & 4MM DIA. FEMALE INST. PLUG

## 5MM DIAMETER MONOPOLAR ELECTRODES-FOR USE W/ HAND-SWITCHING HANDLES



"J"



"L"



SPATULA



CONE

|      |          |
|------|----------|
| 33CM | 52850-81 |
| 36CM | 52836-81 |
| 45CM | 52815-81 |

|      |          |
|------|----------|
| 33CM | 52850-82 |
| 36CM | 52836-82 |
| 45CM | 52815-82 |

|      |          |
|------|----------|
| 33CM | 52850-83 |
| 36CM | 52836-83 |
| 45CM | 52815-83 |

|      |          |
|------|----------|
| 33CM | 52850-84 |
| 36CM | 52836-84 |
| 45CM | 52815-84 |



BALL



KNIFE



NEEDLE



BUTTON

|      |          |
|------|----------|
| 33CM | 52850-85 |
| 36CM | 52836-85 |
| 45CM | 52815-85 |

|      |          |
|------|----------|
| 33CM | 52850-86 |
| 36CM | 52836-86 |
| 45CM | 52815-86 |

|      |          |
|------|----------|
| 33CM | 52850-87 |
| 36CM | 52836-87 |
| 45CM | 52815-87 |

|      |          |
|------|----------|
| 33CM | 52850-88 |
| 36CM | 52836-88 |
| 45CM | 52815-88 |



# ELMED RETRACTABLE NEEDLE ELECTRODES FOR PRECISE CUTTING & COAGULATION



MADE IN THE USA

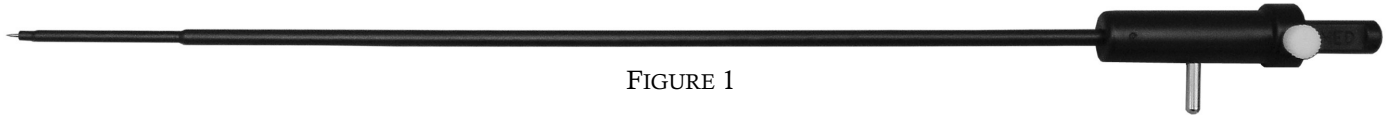

FIGURE 1

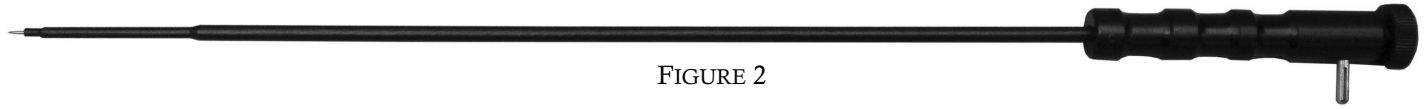

FIGURE 2

| ITEM NO.         | DESCRIPTION  |
|------------------|--|
| <b>52205-53</b>  | 30CM INSULATED CUTTING ELECTRODE, RETRACTABLE NEEDLE, ACCORDING TO DR. VALLE, 5MM DIA. SHAFT W/ 3MM TIP FOR BETTER VISION, SET SCREW ADJUSTMENT (FIG. 1) |
| <b>52205-54</b>  | REPLACEMENT STYLET, FOR #52205-53  |
| <b>52205-69</b>  | 30CM INSULATED CUTTING ELECTRODE, RETRACTABLE NEEDLE, W/ IRRIGATION BY TRUMPET VALVE, ACCORDING TO DR. VALLE, 5MM DIA. SHAFT, SET SCREW ADJUSTMENT       |
| <b>52205-70</b>  | IRRIGATION SLEEVE ONLY, FOR #52205-69  |
| <b>52205-110</b> | 30CM INSULATED CUTTING ELECTRODE, RETRACTABLE NEEDLE, 5MM DIA. SHAFT W/ 3MM TIP FOR BETTER VISION, SPRING LOADED PUSH BUTTON (FIG. 2)                    |

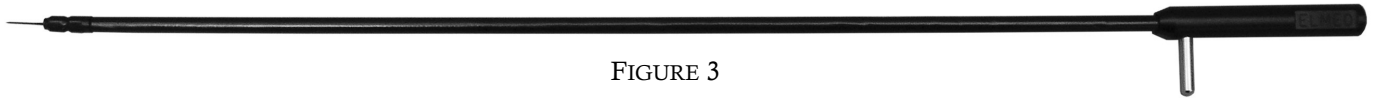

FIGURE 3

| ITEM NO.        | DESCRIPTION   |
|-----------------|---|
| <b>52205-48</b> | 30CM INSULATED CUTTING ELECTRODE, W/ CHUCK FOR MICRO NEEDLES, ACCORDING TO DR. VALLE, 5MM DIA. SHAFT (FIG. 3) |
| <b>52005-33</b> | REPLACEMENT 150 MICRON NEEDLE FOR #52205-48   |
| <b>52005-34</b> | REPLACEMENT 500 MICRON NEEDLE FOR #52205-48   |

## MONOPOLAR CABLES FOR USE WITH ELECTRODES



### 52005-31

4MM DIA. PLUG (UNIT) & 4MM DIA. FEMALE INST. PLUG



### 52005-32

8MM DIA. "BOVIE" PLUG (UNIT) & 4MM DIA. FEMALE INST. PLUG



# REUSABLE CABLES FOR MONOPOLAR INSTRUMENTS & GENERATORS



MADE IN THE USA



4MM "BANANA" GENERATOR END

## INSTRUMENT END



8MM "BOVIE" GENERATOR END

| ITEM NO. | DESCRIPTION  |
|----------|--|
| 5021     | 4MM DIA. MALE INST. PLUG   |
| 5022     | OLSEN TYPE SCREW-ON INST. PLUG                                   |
| 5029     | OLYMPUS TYPE INST. PLUG  |
| 5260     | ACMI TYPE INST. PLUG   |
| 5268     | TAPERED "DOWNS" TYPE INST. PLUG                                  |
| 52005-29 | 3MM DIA. FEMALE INST. PLUG                                       |
| 52005-31 | 4MM DIA. FEMALE INST. PLUG                                       |
| 52005-35 | CORSON NEEDLE ELECTRODE INST. PLUG                               |
| 52005-37 | DUAL STAGE MALE (STORZ) INST. PLUG                               |
| 52005-47 | RESECTOSCOPE INST. PLUG  |
| 52005-49 | 4MM DIA. RECESSED PIN (WOLF/CORSON/STORZ) INST. PLUG             |
| 52005-69 | 4MM DIA. SELF-RETAINING PLUG FOR STORZ SOLID POST INST.          |
| 52005-71 | 4MM DIA. INSULATED OUTER SLEEVE PLUG FOR V. MUELLER INST.        |
| 52005-73 | 4MM DIA. EXTRA-LONG PLUG & 4MM DIA. EXTRA-LONG PLUG: STORZ INST. |
| 52005-75 | 4MM DIA. RIGHT ANGLE FEMALE INST. PLUG                           |
| 52005-77 | MALE LUER LOCK INST. PLUG  |
| 52005-53 | 3MM DIA. RECESSED POST PLUG FOR OLYMPUS RESECTOSCOPE             |
| 5025     | SCREW ON CODMAN TYPE PLUG  |



| ITEM NO. | DESCRIPTION  |
|----------|--|
| 5009     | 4MM DIA. MALE INST. PLUG   |
| 5023     | OLSEN TYPE SCREW-ON INST. PLUG                                   |
| 5030     | OLYMPUS TYPE INST. PLUG  |
| 5261     | ACMI TYPE INST. PLUG   |
| 5269     | TAPERED "DOWNS" TYPE INST. PLUG                                  |
| 52005-30 | 3MM DIA. FEMALE INST. PLUG                                       |
| 52005-32 | 4MM DIA. FEMALE INST. PLUG                                       |
| 52005-36 | CORSON NEEDLE ELECTRODE INST. PLUG                               |
| 52005-38 | DUAL STAGE MALE (STORZ) INST. PLUG                               |
| 52005-48 | RESECTOSCOPE INST. PLUG  |
| 52005-50 | 4MM DIA. RECESSED PIN (WOLF/CORSON/STORZ) INST. PLUG             |
| 52005-70 | 4MM DIA. SELF-RETAINING PLUG FOR STORZ SOLID POST INST.          |
| 52005-72 | 4MM DIA. INSULATED OUTER SLEEVE PLUG FOR V. MUELLER INST.        |
| 52005-74 | 4MM DIA. EXTRA-LONG PLUG & 4MM DIA. EXTRA-LONG PLUG: STORZ INST. |
| 52005-76 | 4MM DIA. RIGHT ANGLE FEMALE INST. PLUG                           |
| 52005-78 | MALE LUER LOCK INST. PLUG  |
| 52005-54 | 3MM DIA. RECESSED POST PLUG FOR OLYMPUS RESECTOSCOPE             |
| 5026     | SCREW ON CODMAN TYPE PLUG  |

## MONOPOLAR CABLE ADAPTERS



5414 ADAPTER FOR MALE "BOVIE" GENERATOR PLUG & 4MM FEMALE BANANA CABLE PLUG



5415 ADAPTER FOR MALE "BOVIE" GENERATOR PLUG & DISPOSABLE INST. PLUG



5416 ADAPTER FOR MALE BANANA GENERATOR PLUG & DISPOSABLE INST. PLUG

# *IRRIGATION & SUCTION INSTRUMENTS*



IN ENDOSCOPIC SURGERY, SUCH AS LAPAROSCOPIC CHOLECYSTECTOMY, PELVISCOPY OR HYSTEROSCOPIC PROCEDURES, THE ELIMINATION OF BLOOD FROM THE SURGICAL FIELD HAS TO BE DONE BY *SUCTION*. SINCE BLOOD NOT ONLY CAN CREATE PROBLEMS DURING THE ELECTROSURGICAL APPROACH, IT ALSO IS OTHERWISE UNDESIRABLE AND THUS, *IRRIGATION* IS TO “WASH” THE SURGICAL FIELD.



# IRRIGATION / SUCTION TUBES



MADE IN THE USA

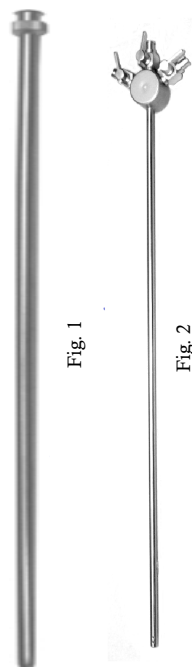

| ITEM NO.         | DESCRIPTION  |
|------------------|--|
| <b>52205-30</b>  | IRRIGATION/SUCTION TUBE W/ LUER FITTING, 33CM, 5MM DIA. -- <b>FIG. 1</b>                             |
| <b>52105-26</b>  | IRRIGATION/SUCTION TUBE W/ LUER FITTING, 45CM, 5MM DIA.  |
| <b>52205-32</b>  | IRRIGATION/SUCTION PROBE W/ CM MARKINGS & STOPCOCK, 33CM, 5MM DIA.                                   |
| <b>52105-28</b>  | IRRIGATION/SUCTION PROBE W/ CM MARKINGS & STOPCOCK, 45CM, 5MM DIA.                                   |
| <b>52205-32T</b> | IRRIGATION/SUCTION PROBE W/ CM MARKINGS & TRUMPET VALVE, 33CM, 5MM DIA.                              |
| <b>52105-28T</b> | IRRIGATION/SUCTION PROBE W/ CM MARKINGS & TRUMPET VALVE, 45CM, 5MM DIA.                              |
| <b>52205-33</b>  | LAVAGE CANNULA W/ 3-WAY STOPCOCK, POOLE SUCTION TIP W/ LATERAL HOLES, 33CM, 5MM DIA.-- <b>FIG. 2</b> |
| <b>52105-33</b>  | LAVAGE CANNULA W/ 3-WAY STOPCOCK, POOLE SUCTION TIP W/ LATERAL HOLES, 45CM, 5MM DIA.                 |

## EXTRA LARGE SUCTION PORTS



| ITEM NO.           | DESCRIPTION  |
|--------------------|--|
| <b>52500-15-00</b> | IRRIGATION/SUCTION SYSTEM W/ DUAL-VALVE HANDLE W/ COLOR CODING |
| <b>52500-15-01</b> | 5MM DIA. 33CM, OPEN TIP SUCTION CANNULA FOR 52500-15           |
| <b>52500-15-02</b> | 10MM DIA. 33CM, OPEN TIP SUCTION CANNULA FOR 52500-15          |
| <b>52500-15-03</b> | 5MM DIA. 45CM, OPEN TIP SUCTION CANNULA FOR 52500-15           |
| <b>52500-15-04</b> | 10MM DIA. 45CM, OPEN TIP SUCTION CANNULA FOR 52500-15          |
| <b>52500-15-05</b> | 5MM DIA. 33CM, POOLE SUCTION CANNULA FOR 52500-15              |
| <b>52500-15-06</b> | 10MM DIA. 33CM, POOLE SUCTION CANNULA FOR 52500-15             |
| <b>52500-15-07</b> | 5MM DIA. 45CM, POOLE SUCTION CANNULA FOR 52500-15              |
| <b>52500-15-08</b> | 10MM DIA. 45CM, POOLE SUCTION CANNULA FOR 52500-15             |



# IRRIGATION / SUCTION TUBES



MADE IN THE USA



| ITEM NO.           | DESCRIPTION   |
|--------------------|---|
| <b>52500-30-00</b> | IRRIGATION/SUCTION SYSTEM W/ DBL. "O" RING TRUMPET VALVE HANDLE, W/ INST. CHANNEL |
| <b>52500-30-01</b> | 5MM DIA. 33CM, OPEN TIP SUCTION CANNULA FOR 52500-30                              |
| <b>52500-30-02</b> | 10MM DIA., 33CM, OPEN TIP SUCTION CANNULA FOR 52500-30                            |
| <b>52500-31-03</b> | 5MM DIA., 45CM, OPEN TIP SUCTION CANNULA FOR 52500-31                             |
| <b>52500-31-03</b> | 10MM DIA., 45CM, OPEN TIP SUCTION CANNULA FOR 52500-31                            |
| <b>52500-30-04</b> | 5MM DIA. 33CM, POOLE TIP SUCTION CANNULA FOR 52500-30                             |
| <b>52500-30-05</b> | 10MM DIA., 33CM, POOLE TIP SUCTION CANNULA FOR 52500-30                           |
| <b>52500-31-06</b> | 5MM DIA., 45CM, POOLE TIP SUCTION CANNULA FOR 52500-31                            |
| <b>52500-31-07</b> | 10MM DIA., 45CM, POOLE TIP SUCTION CANNULA FOR 52500-31                           |

## NETZHET STYLE IRRIGATION/SUCTION SYSTEM



| ITEM NO.           | DESCRIPTION   |
|--------------------|---|
| <b>52500-16-00</b> | NETZHAT STYLE IRRIGATION/SUCTION SYSTEM W/ DUAL TRUMPET VALVE HANDLE, COMPLETE W/ 33CM, 10MM & 5MM DIA. CANNULA |
| <b>52500-16-01</b> | 5MM DIA., 33CM, OPEN TIP SUCTION CANNULA FOR 52500-16   |
| <b>52500-16-02</b> | 10MM DIA., 33CM, OPEN TIP SUCTION CANNULA FOR 52500-16  |
| <b>52500-16-03</b> | 5MM DIA., 45CM, OPEN TIP SUCTION CANNULA FOR 52500-16   |
| <b>52500-16-04</b> | 10MM DIA., 45CM, OPEN TIP SUCTION CANNULA FOR 52500-16  |
| <b>52500-16-05</b> | 5MM DIA., 33CM, POOLE TIP SUCTION CANNULA FOR 52500-16  |
| <b>52500-16-06</b> | 10MM DIA., 33CM, POOLE TIP SUCTION CANNULA FOR 52500-16   |
| <b>52500-16-07</b> | 5MM DIA., 45CM, POOLE TIP SUCTION CANNULA FOR 52500-16  |
| <b>52500-16-08</b> | 10MM DIA., 45CM, POOLE TIP SUCTION CANNULA FOR 52500-16   |



# IRRIGATION / SUCTION TUBES









MADE IN THE USA

## 5MM & 10MM SUCTION/IRRIGATION TUBES FOR HANDLES 52500-26-00 & 52500-25-00

ITEM NO.  
**52500-26-00**

ITEM NO.  
**52500-25-00**



| DIA.                           | LENGTH | TUBE ONLY  | DESCRIPTION        | COMPLETE INSTRUMENT |                    |
|--------------------------------|--------|--|--------------------|---------------------|--------------------|
| OPEN SUCTION TUBE              |        |    |                    |                     |                    |
| 5MM                            | 33CM   | <b>52500-00-01</b>   | 4-HOLE DISTAL TIP  | <b>52500-26-01</b>  | <b>52500-25-01</b> |
| 5MM                            | 33CM   | <b>52500-00-02</b>   | 16-HOLE DISTAL TIP | <b>52500-26-02</b>  | <b>52500-25-02</b> |
| 10MM                           | 33CM   | <b>52500-00-03</b>   | 32-HOLE DISTAL TIP | <b>52500-26-03</b>  | <b>52500-25-03</b> |
| OPEN SUCTION TUBE,<br>BEE HIVE |        |  |                    |                     |                    |
| 5MM                            | 33CM   | <b>52500-00-04</b>   | 48-HOLE DISTAL TIP | <b>52500-26-04</b>  | <b>52500-25-04</b> |
| POOL SUCTION<br>TUBE, BEE HIVE |        |  |                    |                     |                    |
| 5MM                            | 33CM   | <b>52500-00-05</b>   | 48-HOLE DISTAL TIP | <b>52500-26-05</b>  | <b>52500-25-05</b> |
| 5MM                            | 45CM   | <b>52500-00-06</b>   | 48-HOLE DISTAL TIP | <b>52500-26-06</b>  | <b>52500-25-06</b> |
| PUNCTURE NEEDLE                |        |  |                    |                     |                    |
| 5MM                            | 33CM   | <b>52500-00-07</b>   | 15GA NEEDLE        | <b>52500-26-07</b>  | <b>52500-25-07</b> |
| SHORT PUNCTURE                 |        |  |                    |                     |                    |
| 5MM                            | 33CM   | <b>52500-00-08</b>   | 15 GA NEEDLE       | <b>52500-26-08</b>  | <b>52500-25-08</b> |
| POOLE SUCTION                  |        |  |                    |                     |                    |
| 5MM                            | 33CM   | <b>52500-00-09</b>   | 12-HOLE DISTAL TIP | <b>52500-26-09</b>  | <b>52500-25-09</b> |





# IRRIGATION / SUCTION SYSTEMS



MADE IN THE USA



| ITEM NO.        | DESCRIPTION                                |
|-----------------|--|
| <b>52205-30</b> | 5MM, 33CM OPEN FLAT TIP IRRIGATION/SUCTION |



| ITEM NO.         | DESCRIPTION   |
|------------------|---|
|                  | REUSABLE STAINLESS STEEL IRRIGATION/SUCTION CANNULA W/ MULTIPLE SIDE PORT HOLES & BARB HOSE FITTING |
| <b>52205-30B</b> | 5MM Ø, 33CM   |
| <b>52105-26B</b> | 5MM Ø, 45CM   |



| ITEM NO.         | DESCRIPTION  |
|------------------|--|
|                  | REUSABLE STAINLESS STEEL IRRIGATION/SUCTION CANNULA W/ STOPCOCK. FEATURING: CM MARKINGS ON DISTAL TIP ( SIDE PORT HOLES-N/C OPTION ADD LETTER "M") |
| <b>52205-32</b>  | 5MM DIA. 33CM  |
| <b>52105-32L</b> | 5MM DIA. 45CM  |

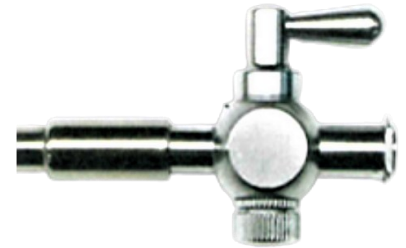

| ITEM NO.         | DESCRIPTION   |
|------------------|---|
|                  | REUSABLE STAINLESS STEEL IRRIGATION/SUCTION CANNULA W/ STOPCOCK & BARB FITTING. FEATURING: CM MARKINGS ON DISTAL TIP ( SIDE PORT HOLES-N/C OPTION ADD LETTER "M") |
| <b>52205-32B</b> | 5MM DIA. 33CM   |
| <b>52105-25L</b> | 5MM DIA. 45CM   |

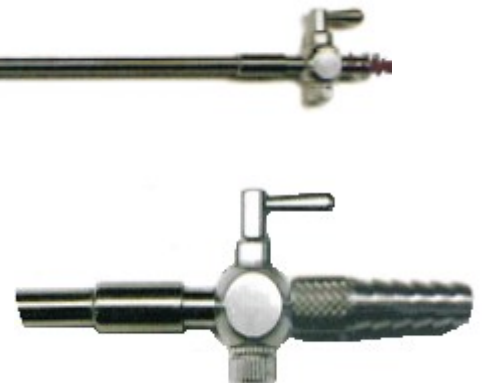







# SINGLE TRUMPET OR PISTOL GRIP SUCTION/IRRIGATION SYSTEMS



MADE IN THE USA

## 5MM & 10MM SUCTION/IRRIGATION TUBES FOR HANDLES 52500-27-00 & 52500-28-00

|  |        |                             |                                   | LIST NO.  | LIST NO.  |
|--|--------|-----------------------------|-----------------------------------|---|---|
|  |        |                             |                                   |  |  |
| DIA.   | LENGTH | TUBE ONLY                   | DESCRIPTION                       | COMPLETE INSTRUMENT   |   |
|  |        |                             |                                   |   |   |
| 3MM  | 33CM   | <a href="#">52500-00-10</a> | 4-HOLE DISTAL TIP W/ CM MARKINGS  |   | <a href="#">52500-28-10</a>   |
| 3MM  | 33CM   | <a href="#">52500-00-11</a> | 16-HOLE DISTAL TIP W/ CM MARKINGS | <a href="#">52500-27-11</a>   | <a href="#">52500-28-11</a>   |
|  |        |                             |                                   |   |   |
| 5MM  | 33CM   | <a href="#">52500-00-12</a> | 4-HOLE DISTAL TIP W/ CM MARKINGS  | <a href="#">52500-27-12</a>   | <a href="#">52500-28-12</a>   |
| 5MM  | 33CM   | <a href="#">52500-00-13</a> | 16-HOLE DISTAL TIP W/ CM MARKINGS | <a href="#">52500-27-13</a>   | <a href="#">52500-28-13</a>   |
|  |        |                             |                                   |   |   |
| 10MM   | 33CM   | <a href="#">52500-00-14</a> | 4-HOLE DISTAL TIP W/ CM MARKINGS  | <a href="#">52500-27-14</a>   | <a href="#">52500-28-14</a>   |
| 10MM   | 33CM   | <a href="#">52500-00-15</a> | 16-HOLE DISTAL TIP W/ CM          | <a href="#">52500-27-15</a>   | <a href="#">52500-28-15</a>   |

## TRIPLE FUNCTION SUCTION / IRRIGATION CANNULA

OUR SPECIAL TRIPLE FUNCTION IRRIGATION/SUCTION INSTRUMENTS FEATURE INTERCHANGEABLE CANNULA AND WILL ACCEPT STANDARD INSTRUMENTS THROUGH THEIR CENTER ALLOWING THREE FUNCTIONS THROUGH ONE PORTAL. THE INSTRUMENTS CONSIST OF UNIQUE HANDLES, LIST NO. 52500-11, INCORPORATING TWO TRUMPET VALVES WITH 7MM DIAMETER PORTS, ONE CONTROLS THE SUCTION, THE OTHER ONE CONTROLS THE IRRIGATION. THE 7MM DIAMETER PORTS AND PERFECT SEAL TRUMPET VALVE PROVIDE A GREATER FLOW VOLUME, NO CLOGGING AND PERFECT SEALING, THUS PREVENTING THE IRRIGATION FLUID FROM LEAKING INTO THE INSTRUMENT. THESE HANDLES AND THEIR RESPECTIVE CANNULA WILL ACCEPT STANDARD DIAMETER LAPAROSCOPIC AND PELVICOSCOPIC INSTRUMENTS.

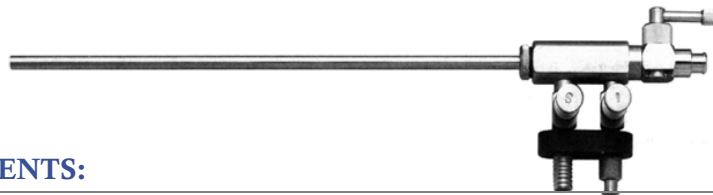

### INDIVIDUAL COMPONENTS:

| ITEM No.                    | DESCRIPTION   |
|-----------------------------|---|
| <a href="#">52500-11-00</a> | ELMED TRIPLE-FUNCTION SUCTION/IRRIGATION SHORT HANDLE W/ TWO 7MM DIA. TRUMPET VALVES, W/OUT CANNULA |
| <a href="#">52505-21</a>    | 5MM DIA., 33CM LONG CANNULA, (FOR 3MM DIA. INSTRUMENTS)   |
| <a href="#">52505-22</a>    | 5MM DIA., 33CM LONG SUCTION CANNULA, W/ POOLE SUCTION TIP   |
| <a href="#">52505-23</a>    | 5MM DIA., 45CM LONG CANNULA, (FOR 3MM DIA. INSTRUMENTS)   |
| <a href="#">52505-24</a>    | 5MM DIA., 45CM LONG SUCTION CANNULA, W/ POOLE SUCTION TIP   |
| <a href="#">52510-01</a>    | 10MM DIA., 33CM LONG CANNULA, (FOR 3MM DIA. INSTRUMENTS)  |
| <a href="#">52510-02</a>    | 10MM DIA., 33CM LONG SUCTION CANNULA, 5MM DIA., W/ POOLE SUCTION TIP                                |
| <a href="#">52510-03</a>    | 10MM DIA., 45CM LONG CANNULA, 5MM DIA. (FOR 3MM DIA. INSTRUMENTS)                                   |
| <a href="#">52510-04</a>    | 10MM DIA., 45CM LONG SUCTION CANNULA, 5MM DIA., W/ POOLE SUCTION TIP                                |



# IRRIGATION / SUCTION TUBES FOR DISPOSABLE HANDLES



MADE IN THE USA



| STYLE  | DIAMETER | LENGTH | STRYKER™<br>STYLE | BAIRD™/<br>DAVOL™<br>STYLE | CARDINAL<br>HEALTH™<br>PULSEWAVE<br>™<br>STYLE | CIRCON™/<br>ACMI™<br>SURGI-<br>FLEX™<br>STYLE | COMED™<br>CORE<br>STYLE |
|--|----------|--------|-------------------|----------------------------|--|---|-------------------------|
| REGULAR TIP -<br>VENTED<br><br>STAINLESS<br>STEEL FINISH | 3MM      | 20CM   | 52720-403         | 52920-403                  | 52420-403                                      | 52620-403                                     | 52820-403               |
|  | 3MM      | 30CM   | 52730-403         | 52930-403                  | 52430-403                                      | 52630-403                                     | 52830-403               |
|  | 5MM      | 28CM   | 52728-403         | 52928-403                  | 52428-403                                      | 52628-403                                     | 52828-403               |
|  | 5MM      | 32CM   | 52732-403         | 52932-403                  | 52432-403                                      | 52632-403                                     | 52832-403               |
|  | 5MM      | 45CM   | 52745-403         | 52945-403                  | 52445-403                                      | 52645-403                                     | 52845-403               |
|  | 10MM     | 28CM   | 52728-404         | 52928-404                  | 52428-404                                      | 52628-404                                     | 52828-404               |
|  | 10MM     | 32CM   | 52732-404         | 52932-404                  | 52432-404                                      | 52632-404                                     | 52832-404               |
| REGULAR TIP<br>-NON-VENTED<br><br>REFLECTIVE<br>FINISH   | 3MM      | 20CM   | 52720-409         | 52920-409                  | 52420-409                                      | 52620-409                                     | 52820-409               |
|  | 3MM      | 30CM   | 52730-409         | 52930-409                  | 52430-409                                      | 52630-409                                     | 52830-409               |
|  | 5MM      | 28CM   | 52728-409         | 52928-409                  | 52428-409                                      | 52628-409                                     | 52828-409               |
|  | 5MM      | 32CM   | 52732-409         | 52932-409                  | 52432-409                                      | 52632-409                                     | 52832-409               |
|  | 5MM      | 45CM   | 52745-409         | 52945-409                  | 52445-409                                      | 52645-409                                     | 52845-409               |
|  | 10MM     | 28CM   | 52728-410         | 52928-410                  | 52428-410                                      | 52628-410                                     | 52828-410               |
|  | 10MM     | 32CM   | 52732-410         | 52932-410                  | 52432-410                                      | 52632-410                                     | 52832-410               |
| POOLE<br>SUCTION TIP                                     | 3MM      | 20CM   | 52720-406         | 52920-406                  | 52420-406                                      | 52620-406                                     | 52820-406               |
|  | 3MM      | 30CM   | 52730-406         | 52930-406                  | 52430-406                                      | 52630-406                                     | 52830-406               |
|  | 5MM      | 28CM   | 52728-406         | 52928-406                  | 52428-406                                      | 52628-406                                     | 52828-406               |
|  | 5MM      | 32CM   | 52732-406         | 52932-406                  | 52432-406                                      | 52632-406                                     | 52832-406               |
|  | 5MM      | 45CM   | 52745-406         | 52945-406                  | 52445-406                                      | 52645-406                                     | 52845-406               |
|  | 10MM     | 28CM   | 52728-405         | 52928-405                  | 52428-405                                      | 52628-405                                     | 52828-405               |
|  | 10MM     | 32CM   | 52732-405         | 52932-405                  | 52432-405                                      | 52632-405                                     | 52832-405               |
|  | 10MM     | 45CM   | 52745-405         | 52945-405                  | 52445-405                                      | 52645-405                                     | 52845-405               |





# IRRIGATION / SUCTION TUBES FOR DISPOSABLE HANDLES



MADE IN THE USA



| STYLE                       | DIAMETER | LENGTH | STRYKER™<br>STYLE | BAIRD™/<br>DAVOL™<br>STYLE | CARDINAL<br>HEALTH™<br>PULSEWAVE<br>™<br>STYLE | CIRCON™/<br>ACMI™<br>SURGI-<br>FLEX™<br>STYLE | COMED™<br>CORE<br>STYLE |
|-----------------------------|----------|--------|-------------------|----------------------------|--|---|-------------------------|
| STONE<br>SCOOPER            | 10MM     | 32CM   | 52732-492         | 52932-492                  | 52432-492                                      | 52632-492                                     | 52832-492               |
|                             | 10MM     | 45CM   | 52745-492         | 52945-492                  | 52445-492                                      | 52645-492                                     | 52845-492               |
| HYDRO-<br>DISSECTION<br>TIP | 3MM      | 20CM   | 52720-407         | 52920-407                  | 52420-407                                      | 52620-407                                     | 52820-407               |
|                             | 3MM      | 30CM   | 52730-407         | 52930-407                  | 52430-407                                      | 52630-407                                     | 52830-407               |
|                             | 5MM      | 32CM   | 52732-407         | 52932-407                  | 52432-407                                      | 52632-407                                     | 52832-407               |
|                             | 5MM      | 45CM   | 52745-407         | 52945-407                  | 52445-407                                      | 52645-407                                     | 52845-407               |
| ASPIRATION<br>NEEDLE TIP    | 3MM      | 20CM   | 52720-437         | 52920-437                  | 52420-437                                      | 52620-437                                     | 52820-437               |
|                             | 3MM      | 30CM   | 52730-437         | 52930-437                  | 52430-437                                      | 52630-437                                     | 52830-437               |
|                             | 5MM      | 32CM   | 52732-437         | 52932-437                  | 52432-437                                      | 52632-437                                     | 52832-437               |
|                             | 5MM      | 45CM   | 52745-437         | 52945-437                  | 52445-437                                      | 52645-437                                     | 52845-437               |

## OPTIONS FOR STAINLESS STEEL CANNULAS:

- NON-REFLECTIVE FINISH— ADD LETTERS “NR” TO NUMBER
- BLACK EBONIZED FINISH FOR LASER APPLICATION—ADD LETTER “E” TO NUMBER
- CUSTOM WORKING LENGTH—ADD LENGTH TO DESCRIPTION—NON-RETURNABLE





# MONOPOLAR RF ELECTRODES FOR DISPOSABLE HANDLES



MADE IN THE USA

- DOUBLE INSULATED W/ REPLACEABLE TIP PROTECTOR SLEEVE FOR INCREASED SAFETY
- QUICK DISCONNECT FOR EASY CLEANING & RE-STERILIZATION
- SUCTION / IRRIGATION WITH CUTTING COAGULATION

| STYLE                       | DIAMETER | LENGTH | STRYKER™<br>STYLE | BAIRD™/<br>DAVOL™<br>STYLE | CARDINAL<br>HEALTH™<br>PULSEWAVE™<br>STYLE | CIRCON™/<br>ACMI™<br>SURGI-FLEX™<br>STYLE | COMED™<br>CORE<br>STYLE |
|-----------------------------|----------|--------|-------------------|----------------------------|--|---|-------------------------|
| SPATULA<br>TIP              | 5MM      | 32CM   | 52732-441         | 52932-441                  | 52432-441                                  | 52632-441                                 | 52832-441               |
|                             | 5MM      | 45CM   | 52745-441         | 52945-441                  | 52445-441                                  | 52645-441                                 | 52845-441               |
| L-HOOK TIP                  | 5MM      | 32CM   | 52732-442         | 52932-442                  | 52432-442                                  | 52632-442                                 | 52832-442               |
|                             | 5MM      | 45CM   | 52745-442         | 52945-442                  | 52445-442                                  | 52645-442                                 | 52845-442               |
| J-HOOK TIP                  | 5MM      | 32CM   | 52732-443         | 52932-443                  | 52432-443                                  | 52632-443                                 | 52832-443               |
|                             | 5MM      | 45CM   | 52745-443         | 52945-443                  | 52445-443                                  | 52645-443                                 | 52845-443               |
| NEEDLE TIP                  | 5MM      | 32CM   | 52732-444         | 52932-444                  | 52432-444                                  | 52632-444                                 | 52832-444               |
|                             | 5MM      | 45CM   | 52745-444         | 52945-444                  | 52445-444                                  | 52645-444                                 | 52845-444               |
| BALL TIP                    | 5MM      | 32CM   | 52732-445         | 52932-445                  | 52432-445                                  | 52632-445                                 | 52832-445               |
|                             | 5MM      | 45CM   | 52745-445         | 52945-445                  | 52445-445                                  | 52645-445                                 | 52845-445               |
| BULLET<br>SUCTION<br>TIP    | 5MM      | 32CM   | 52732-446         | 52932-446                  | 52432-446                                  | 52632-446                                 | 52832-446               |
|                             | 5MM      | 45CM   | 52745-446         | 52945-446                  | 52445-446                                  | 52645-446                                 | 52845-446               |
| PROTECTOR<br>SHEATH<br>3/PK | 5MM      | 32CM   | 52732-500         | 52932-500                  | 52432-500                                  | 52632-500                                 | 52832-500               |
|                             | 5MM      | 45CM   | 52745-500         | 52945-500                  | 52445-500                                  | 52645-500                                 | 52845-500               |





# STORZ TYPE LAPAROSCOPIC ELECTRODES







MADE IN THE USA



| ITEM NO.        | DESCRIPTION   |
|-----------------|---|
| <b>52300-00</b> | HANDLE W/ TRUMPET VALVE FOR SUCTION OR IRRIGATION, AUTOCLAVABLE, FOR USE W/ 5MM COAGULATION SUCTION TUBES |



PICTURED **52330-28**

| DISTAL TIP  | SIZE | WORKING LENGTH | INSTRUMENT NO.  | DESCRIPTION                  |
|---|------|----------------|-----------------|------------------------------|
|    | 5MM  | 30CM           | <b>52330-28</b> | COAGULATING CANNULA          |
|   |      | 36CM           | <b>52336-28</b> |                              |
|   |      | 43CM           | <b>52343-28</b> |                              |
|  | 5MM  | 30CM           | <b>52330-58</b> | DISSECTING SPATULA, BLUNT    |
|   |      | 36CM           | <b>52336-58</b> |                              |
|   |      | 43CM           | <b>52343-58</b> |                              |
|  | 5MM  | 30CM           | <b>52330-72</b> | DISSECTING CANNULA, L-SHAPED |
|   |      | 36CM           | <b>52336-72</b> |                              |
|   |      | 43CM           | <b>52343-72</b> |                              |
|  | 5MM  | 30CM           | <b>52330-73</b> | CUSCHIERI DISSECTING HOOK    |
|   |      | 36CM           | <b>52336-73</b> |                              |
|   |      | 43CM           | <b>52343-73</b> |                              |
|  | 5MM  | 30CM           | <b>52330-71</b> | DISSECTING CANNULA, U-SHAPED |
|   |      | 36CM           | <b>52336-71</b> |                              |
|   |      | 43CM           | <b>52343-71</b> |                              |





# STORZ TYPE LAPAROSCOPIC ELECTRODES





MADE IN THE USA

| ITEM NO.  | DESCRIPTION   |
|---|---|
|  52336-72 | 5MM, 36 CM INSULATED MONOPOLAR "L" HOOK COAGULATION & DISSECTING ELECTRODE W/ RF POST |

| ITEM NO.  | DESCRIPTION  |
|---|--|
|  52336-58 | 5MM, 36 CM INSULATED MONOPOLAR SPATULA COAGULATION & DISSECTING ELECTRODE W/ RF POST |

| ITEM NO.  | DESCRIPTION   |
|---|---|
|  52336-71 | 5MM, 36 CM INSULATED MONOPOLAR "J" HOOK COAGULATION & DISSECTING ELECTRODE W/ RF POST |

| ITEM NO.   | DESCRIPTION  |
|--|--|
|  52336-103 | 5MM, 36 CM SUCTION & IRRIGATION TUBE W/ LATERAL HOLES & CM MARKINGS FOR STORZ SUCTION/IRRIGATION HANDLE, STAINLESS STEEL |

| ITEM NO.  | DESCRIPTION  |
|---|--|
|  52336-03 | 5MM, 36 CM SUCTION & IRRIGATION CANNULA W/ LATERAL HOLES & CM MARKINGS FOR STORZ SUCTION/IRRIGATION HANDLE |

| ITEM NO.   | DESCRIPTION  |
|--|--|
|  52005-95 | MONOPOLAR RF CABLE W/ 4MM FEMALE BANANA INSTRUMENT PLUG & DOUBLE CONTACT UNIT PLUG FOR USE W/ HF UNITS |





# TESTING, CLEANING, STERILIZATION & STORAGE

WITH THE RAPIDLY INCREASING USE OF ELECTROSURGICAL INSTRUMENTATION DURING LAPAROSCOPIC PROCEDURES, THE RISK OF INJURIES TO PATIENT AND SURGEON HAS MULTIPLIED. MANY SURGEONS, FAMILIAR TO OPEN SURGERY, OFTEN DO NOT APPRECIATE THAT LAPAROSCOPIC PROCEDURES, EMPLOYING HIGH-FREQUENCY CURRENT, REQUIRE DIFFERENT WAVEFORMS AND TECHNIQUES.

*ELMED* HAS BEEN AT THE FOREFRONT OF CREATING SAFER ELECTROSURGICAL INSTRUMENTATION FOR LAPAROSCOPIC PROCEDURES. BASED ON OVER 40 YEARS OF EXPERIENCE, WE HAVE DEVELOPED AND PRODUCED LAPAROSCOPIC GENERATORS AND MANY SAFETY INNOVATIONS IN COLLABORATION WITH LEADING LAPAROSCOPIC SURGEONS.

*ELMED* REALIZES THAT EVEN THE FINEST EQUIPMENT IS ONLY AS GOOD AS THE SUPPLIES NEEDED TO OPERATE IT. THUS, WE PAY GREAT ATTENTION TO THE QUALITY OF SUPPLIES FOR ENDOSCOPIC INSTRUMENTATION.



# ELMED ENDO-TEST UNITS FOR INSULATION TESTING



MADE IN THE USA

## 1ST GENERATION



ITEM NO.  
**52-5685**

ELMED ENDO-TEST UNIT - COMPLETE PKG. INCLUDES:  
AUTOCLAVABLE TEST ELECTRODES (INSULATION TEST); 3MM SPONGES (5), 5MM SPONGES (5) & 10MM SPONGES (5); TEST CABLES (INSULATION TEST).  
\*PLEASE SPECIFY CABLE FOR VALLEYLAB UNITS IF REQUIRED – ORDER EXTRA

## 2ND GENERATION



**52-5686**

ELMED ENDO-TEST UNIT W/ MONOPOLAR & BIPOlar CABLE TESTER CIRCUIT COMPLETE PKG. INCLUDES SAME AS #52-5685 PLUS ADAPTERS & CABLE REQUIRED FOR CABLE TEST

## 3RD GENERATION



**52-5687**

ELMED ENDO-TEST UNIT W/ MONOPOLAR & BIPOlar CABLE TESTER CIRCUIT W/ ADVANCED SENSORY DETECTION OF INSULATION DEFECTS: COMPLETE PKG. INCLUDES SAME AS #52-5685 PLUS ADAPTERS & CABLE REQUIRED FOR CABLE TEST

### ACCESSORIES FOR ENDO-TEST:

| ITEM NO.          | DESCRIPTION  |
|-------------------|--|
| <b>52-5685-01</b> | ELECTRODE FOR CAPACITANCE TEST                         |
| <b>52-5685-02</b> | ELECTRODE FOR INSULATION TEST                          |
| <b>52-5685-03</b> | 5MM SPONGE INSERT FOR INSULATION TEST (10/PKG.)        |
| <b>52-5685-04</b> | 10MM SPONGE INSERT FOR INSULATION TEST (10/PKG.)       |
| <b>52-5685-05</b> | TEST CABLE FOR INSULATION TEST W/ 4MM FEMALE CONNECTOR |
| <b>52-5685-06</b> | TEST CABLE FOR CAPACITANCE TEST W/ ¼" PHONO PLUG       |
| <b>52-5685-07</b> | *TEST CABLE FOR CAPACITANCE TEST FOR VALLEYLAB UNITS   |
| <b>52-5685-08</b> | 3MM SPONGE INSERTS FOR INSULATION TEST (10/PKG.)       |

### ACCESSORIES FOR CABLE TESTER:

| ITEM NO.          | DESCRIPTION   |
|-------------------|---|
| <b>52-5686-11</b> | BIPOLAR ADAPTER CABLE   |
| <b>52-5686-12</b> | BOVIE PLUG ADAPTER  |
| <b>52-5686-13</b> | BANANA PLUG ADAPTER   |
| <b>52-5686-14</b> | BANANA PLUG CONVERTER ADAPTER   |
| <b>52-5680-15</b> | BIPOLAR CABLE ADAPTER FOR KLEPPINGER FORCEPS CABLES                                     |
| <b>52-5680-16</b> | BIPOLAR CABLE ADAPTER FOR 2-PIN PLUG CABLES   |
| <b>52-5680-17</b> | ALLIGATOR TEST CLIP FOR ENDO-TESTER   |
| <b>52-5685-10</b> | INSULATED HANDLE TEST ELECTRODE W/ ATTACHED CABLE, FOR USE W/ INSULATION TEST ELECTRODE |



# SUPPLIES FOR LAPAROSCOPIC PROCEDURES & INSTRUMENT MAINTENANCE



MADE IN THE USA

THE ELMED INSTRUMENT CLEANING KIT IS AN EFFECTIVE AND EASY-TO-USE SOLUTION TO YOUR LAPAROSCOPIC INSTRUMENTATION CLEANING NEEDS. IT WAS DESIGNED WITH YOUR CONVENIENCE IN MIND.

THE ELMED INSTRUMENT CLEANING KIT CONSISTS OF **52003-80** & **52003-81**

- A) SHEATHS & INSERT, SYRINGES, INJECTION CANNULA
  - B) SHEATHS, PIPETTES
  - C) CATHETERS
  - D) DRAINAGE TUBES
  - E) COCKS, CANNULA & SYRINGES
  - F) BOTTLES
  - G) DOUCHE FITTINGS
  - H) WATER JET PUMP
- (ALSO SUITABLE FOR DRYING IN CONJUNCTION W/ THE FITTINGS)



ITEM NO. **52003-80** | WATER JET CLEANING GUN FOR CONNECTION TO WATER FAUCET

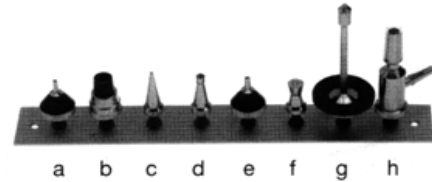

ITEM NO. **52003-81** | SET OF ADAPTERS FOR THE CLEANING OF (A) THROUGH (H)

## ULTRASTOP "PRO MED" ANTI-FOGGING AGENT



ULTRASTOP IS THE MOST COST-EFFECTIVE METHOD OF PROTECTING YOUR MEDICAL OPTICS FROM FOGGING UP: IT ELIMINATES THE NEED TO WARM UP YOUR ENDOSCOPES PRIOR TO USE; AND DUE TO ITS REUSABLE STERILE PACKAGING (30 CC BOTTLES) IT CAN BE USED OVER AND OVER AGAIN

ITEM NO. **52003-37** | ULTRASTOP, PER DOZENS BOTTLES

ITEM NO. **52003-38** | ULTRASTOP, PER BOTTLE

## LUBRICATING OIL FOR SURGICAL INSTRUMENTS



TO MAINTAIN HIGH QUALITY OF COSTLY SURGICAL INSTRUMENT JOINTS AND OTHER COMPONENTS, A LIGHT APPLICATION OF SURGICAL INSTRUMENTS SHOULD BE MADE PRIOR TO STERILIZATION

ITEM NO. **52003-39** | ONE DOZEN, 0.5 OZ EACH, NON-STERILE

ITEM NO. **52003-40** | ONE BOTTLE, 0.5 OZ. EACH, NON-STERILE



# SUPPLIES FOR LAPAROSCOPIC PROCEDURES & INSTRUMENT MAINTENANCE



MADE IN THE USA

## CLEANING BRUSHES FOR ENDOSCOPIC INSTRUMENTS



| ITEM NO.<br>(QTY. 10) | STAINLESS STEEL WIRE AND ANTI-MICROBIAL MADE IN THE USA                       | ITEM NO.<br>(QTY. 1) |
|-----------------------|---|----------------------|
| <b>52003-56</b>       | 2MM Ø FOR 2MM Ø CANNULAS (12" LONG)   | <b>52003-57</b>      |
| <b>52003-21</b>       | 4MM Ø FOR 3, 4MM Ø CANNULAS (TROCAR SLEEVES, ETC.) 12" LONG                   | <b>52003-22</b>      |
| <b>52003-23</b>       | 6MM Ø FOR 5, 6MM Ø CANNULAS (TROCAR SLEEVES, ETC.) 12" LONG                   | <b>52003-24</b>      |
| <b>52003-25</b>       | 8MM Ø FOR 7, 8MM Ø CANNULAS (TROCAR SLEEVES, ETC.) 12" LONG                   | <b>52003-26</b>      |
| <b>52003-27</b>       | 12MM Ø FOR 10, 11, 12MM Ø CANNULAS (TROCAR SLEEVES, ETC.) 12" LONG            | <b>52003-28</b>      |
| <b>52003-29</b>       | 4MM Ø FOR 3, 4MM Ø CANNULAS (SINGLE PUNCTURE LAPAROSCOPE, ETC.) 19" LONG      | <b>52003-30</b>      |
| <b>52003-31</b>       | 6MM Ø FOR 5, 6 MM Ø CANNULAS (S.P. LAPAROSCOPE, BIPOLAR FCPS, ETC.) 19" LONG  | <b>52003-32</b>      |
| <b>52003-33</b>       | 8MM Ø FOR 7, 8MM Ø CANNULAS (S.P. LAPAROSCOPE, SUCTION TUBES, ETC.) 19" LONG  | <b>52003-34</b>      |
| <b>52003-48</b>       | 12MM Ø FOR 10, 11, 12MM Ø CANNULAS (LAP. INST., SUCTION TUBES, ETC.) 19" LONG | <b>52003-49</b>      |
| <b>52003-35</b>       | VERESS NEEDLES (8" LONG)  | <b>52003-36</b>      |
| <b>52003-41</b>       | NYLON BRISTLE BRUSH W/ HANDLE 7" LONG <b>52003-43</b>                         | <b>52003-42</b>      |
| <b>52003-45</b>       | STAINLESS STEEL BRISTLE BRUSH W/ HANDLE 7" LONG                               | <b>52003-47</b>      |
| <b>52003-54</b>       | DBL. END NYLON BRISTLE BRUCH W/ HANDLE FOR LAPAROSCOPIC INST. 7" LONG         | <b>52003-55</b>      |



# STERILIZATION & STORAGE CONTAINERS FOR LAP INSTRUMENTS & SCOPES



MADE IN THE USA

## NEW FROM ELMED!!!

LIGHT WEIGHT ALUMINUM STERILIZATION & STORAGE CONTAINERS THAT CAN HOLD UP TO 16 INSTRUMENTS (ALSO AVAILABLE WITH A REMOVABLE (FOR GENERAL INSTRUMENTS AS WELL))



**52038-48**

ALUMINUM LIGHTWEIGHT LAP INSTRUMENT STERILIZATION & STORAGE CONTAINER FOR 33CM & 45CM INSTRUMENTS; HOLDS UP TO 16 5MM & 10MM DIA. INSTRUMENTS (26" X 10" X 7")

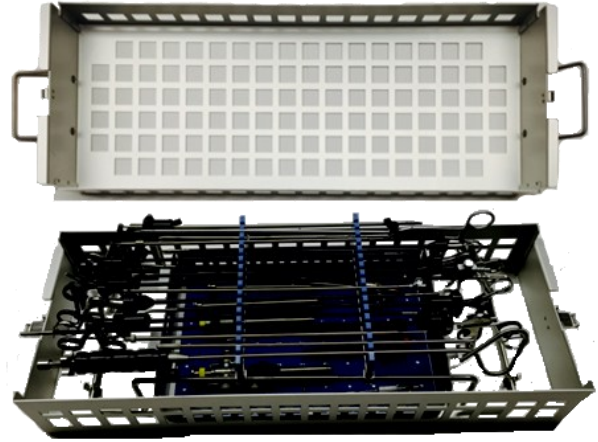

**52038-49**

ALUMINUM LIGHTWEIGHT LAP INSTRUMENT STERILIZATION & STORAGE CONTAINER FOR 33CM & 45CM INSTRUMENTS; HOLDS UP TO 16 5MM & 10MM DIA. INSTRUMENTS ALONG W/ TAKE OUT TRAY FOR MISC. INSTRUMENTS (26" X 10" X 7")



**52038-53**

LAP INSTRUMENT STERILIZATION & STORAGE CONTAINER FOR 33CM INSTRUMENTS; HOLDS UP TO 12 5MM & 10MM DIA. INSTRUMENTS (MOLDED MEDICAL GRADE POLYMER, 21" X 10" X 4")



**52038-51**

LAP INSTRUMENT CONTAINER W/ REMOVABLE TRAY FOR 33CM INSTRUMENT HOLDS UP TO 12 5MM & 10 DIA. INSTRUMENTS (MOLDED MEDICAL GRADE POLYMER & SILICONE, 21" X 10" X 7")

**52038-54**

LAP INSTRUMENT STERILIZATION & STORAGE CONTAINER FOR 45CM INSTRUMENT; HOLDS UP TO 16 5 & 10MM DIA. INSTRUMENTS (MOLDED MEDICAL GRADE POLYMER, 25" X 12" X 5")

**52038-52**

LAP INSTRUMENT CONTAINER W/ REMOVABLE TRAY FOR 45CM INSTRUMENT HOLDS UP TO 10 5 & 10MM DIA. INSTRUMENTS (MOLDED MEDICAL GRADE POLYMER & SILICONE, 26" X 9 1/2" X 7")





# STERILIZATION & STORAGE CONTAINERS FOR LAP INSTRUMENTS & SCOPES



MADE IN THE USA



**52037-00-B4**

ALUMINUM STERILIZATION CONTAINER 25" X 5" X 2", w/ 4 BARS



**52037-00-B2**

ALUMINUM STERILIZATION CONTAINER 25" X 5" X 2", w/ 2 BARS



**52037-07**

THERMOPLASTIC STERILIZATION & STORAGE CONTAINER W/ SILICONE MOUNTING BARS FOR MULTIPLE LAP/HYSTO/CYSTO SCOPE OR SINGLE HYST/CYST SHEATH SYSTEM, (MOLDED MEDICAL GRADE POLYMER & SILICONE), 18"L X 7"W X 1.5"H



**52037-06**

THERMOPLASTIC STERILIZATION & STORAGE CONTAINER FOR 2 LAP/HYSTO/CYSTO SCOPES OR SINGLE HYST/CYST SHEATH SYSTEM, (MOLDED MEDICAL GRADE POLYMER & SILICONE), 18"L X 3"W X 1.5"H

## ALSO AVAILABLE

|                 |   |
|-----------------|---|
| <b>52037-05</b> | THERMOPLASTIC STERILIZATION & STORAGE CONTAINER FOR SINGLE LAP/HYSTO/CYSTO SCOPE OR SINGLE HYST/CYST SHEATH SYSTEM (MOLDED MEDICAL GRADE POLYMER & SILICONE) 18"L X 3"W X 1.5"H                 |
| <b>52037-08</b> | THERMOPLASTIC STERILIZATION & STORAGE CONTAINER (DBL. HEIGHT) FOR MULTIPLE LAP/HYSTO/CYSTO SCOPE OR SINGLE HYST/CYST SHEATH SYSTEM, (MOLDED MEDICAL GRADE POLYMER & SILICONE), 18"L X 7"W X 3"H |
| <b>52038-15</b> | STERILIZATION & STORAGE CONTAINER FOR EXTRA-LONG SCOPE & CABLE, 25" X 6" X 1.5" (MOLDED MEDICAL GRADE POLYMER & SILICONE); HOLDS 2 SCOPES UP TO 50CM LONG                                       |
| <b>52037-11</b> | MUSLIN CLOTH FOR <b>52037-00</b> & <b>52037-01</b> CONTAINER  |





# STERILIZATION & STORAGE CONTAINERS FOR LAP INSTRUMENTS & SCOPES



MADE IN THE USA

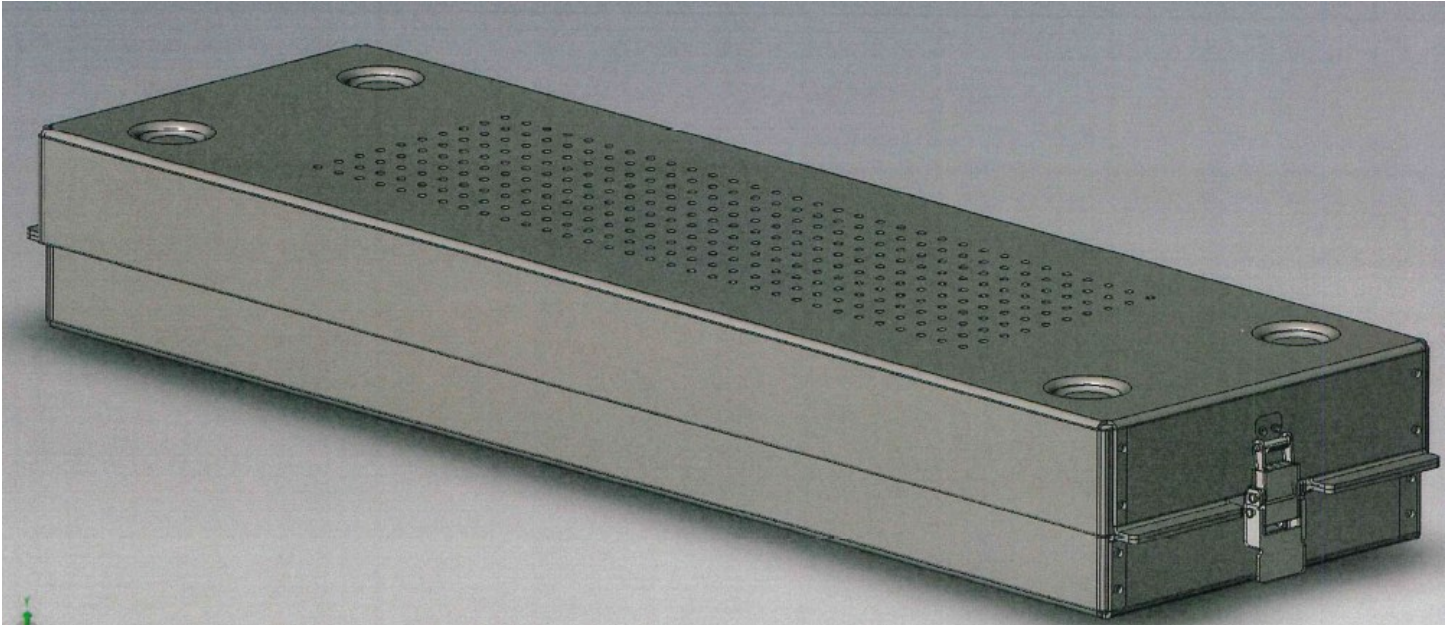

| ITEM NO.           | DESCRIPTION   |
|--------------------|---|
| <b>52037-26</b>    | ALUMINUM STERILIZATION & STORAGE CONTAINER WITH LATCH . 26" x 8" x 3" |
| <b>52037-26S</b>   | WITH SILICONE MAT   |
| <b>52037-26-B2</b> | WITH 2 SILICONE MOUNTING BARS   |
| <b>52037-26-B4</b> | WITH 4 SILICONE MOUNTING BARS   |





# SERVICE AND REPAIR



MADE IN THE USA

IN NEED OF INSTRUMENT REPAIRS? SEND THEM TO THE *ER!*

## ELMED REPAIR

60 YEARS OF EXPERIENCE AND KNOWLEDGE IN DESIGNING, ENGINEERING, MANUFACTURING AND REPAIRING FOR THE MEDICAL COMMUNITY HAS GIVEN ELMED, INC. ONE OF THE BEST REPUTATIONS IN THE INDUSTRY. WE REPAIR WHAT OTHERS ARE UNABLE OR UNWILLING TO DO AND WE REPAIR ALL COMPETITIVE BRANDS. OUR WORK IS PERFORMED BY SKILLED TECHNICIANS, ALL OF WHICH HAVE BEEN WITH ELMED FOR THE PAST 10-30 YEARS.

*COMPLETE IN-HOUSE MACHINE SHOP, POWDER COATING, LASER WELDING, & MARKING FINISHING, ELECTRONICS AND OPTICAL DEPARTMENTS*

### AREAS OF SPECIALTY

- LAPAROSCOPIC AND ENDOSCOPIC INSTRUMENTS
- ELECTROSURGICAL UNITS AND ACCESSORIES
- FIBER OPTIC LIGHT CABLES AND RETRACTORS
- RIGID ENDOSCOPES & FLEXIBLE SINUSCOPES
- STAINLESS STEEL HAND INSTRUMENTS
- LIGHT SOURCES AND HEADLIGHTS
- DEBRIDER UNITS, HAND PIECES AND BLADES
- SELF RETAINING RETRACTOR SYSTEMS

### HOW TO PACKAGE AND SHIP INSTRUMENTS

- **IMPORTANT:** ELMED CANNOT ACCEPT INSTRUMENTS THAT HAVE NOT BEEN PROPERLY CLEANED, DISINFECTED OR STERILIZED.
- INCLUDE CUSTOMER NAME AND ALL CONTACT INFORMATION (NAME, ADDRESS, PHONE NO., FAX NO., EMAIL ADDRESS, ETC.)
- INCLUDE CUSTOMER P.O. (PURCHASE ORDER), IF USED
- INCLUDE REASON FOR RETURN - BRIEF DESCRIPTION OF REPAIR PROBLEM IF AVAILABLE
- WRAP INSTRUMENT FOR PROTECTION DURING TRANSPORT
- USE A COMMON CARRIER SUCH AS UPS OR FEDEX
- INSURE THE PACKAGE AND RECORD THE TRACKING NUMBER

**PLEASE FILL OUT, DETACH, AND INCLUDE THE FORM BELOW WITH YOUR REPAIR:**

|                  |                 |
|------------------|-----------------|
| FROM:            |                 |
| FACILITY:        | CONTACT PERSON: |
| ADDRESS:         |                 |
| CITY, STATE, ZIP |                 |
| EMAIL:           | PHONE NO.       |
| PO. No.          | QTY.            |

INSTRUMENT DESCRIPTION:

(NOTE: PLEASE INCLUDE MODEL NO. AND SERIAL NO. IN INSTRUMENT DESCRIPTION FOR SCOPES)

FAST SERVICE: INCOMING REPAIRS COMING IN BY NEXT DAY AIR WILL BE COMPLETED WITHIN 24 HRS (WHEN PARTS ARE AVAILABLE)

SHIP TO: **ELMED** 35 N BRANDON DR., GLENDALE HEIGHTS, IL 60139