

ELMED



SERVING THE MEDICAL PROFESSION SINCE 1955



LAPAROSCOPIC SURGERY

WE DESIGN, MANUFACTURE, & SELL THE TOOLS THE SURGEONS USE

ELMED INC.
35 N. BRANDON DR.
GLENDALE HEIGHTS,
IL 60139
USA

WE SUBSCRIBE TO
COST
CONTAINMENT AND
PROTECTION OF
THE ENVIRONMENT



MADE IN THE USA

THEREFORE, WE
MANUFACTURE
REUSABLE
PRODUCTS FOR A
CLEANER WORLD

PH (224) 353-6446
FAX (224) 653-8178
EMAIL
MEDICAL@ELMED.COM
WWW.ELMED.COM

TABLE OF CONTENTS

TROCARS, CANNULAS & SCOPES	PAGE
ELMED EOS HD LAPAROSCOPES & TP11 TELESCOPE PRE-HEATER	2
ELMED EOS HD OPERATING LAPAROSCOPES & REPLACEMENT PARTS FOR ELMED EOS HD OPERATING LAPAROSCOPES	3
ELMED “LITE” THERMOPLASTIC TROCAR SLEEVES & TROCARS	4
REPLACEMENT ACCESSORIES FOR “LITE” TROCAR SLEEVES	5
ELMED LIGHTWEIGHT MAGNA-CLOSE TROCAR SLEEVES & TROCARS	6
STAINLESS STEEL TROCAR SLEEVES W/ TRUMPET VALVE	7
ELMED STAINLESS STEEL SAFETY TROCARS, SPRING LOADED, DILATION SETS-COMPLETE SLEEVE & PROBE & REDUCERS	8
ELMED HASSON CANNULA FOR OPEN LAPAROSCOPY, REPLACEMENT SEALING CAPS & HASSON “S-SHAPED” RETRACTORS	9
LAPAROSCOPIC ADAPTERS	10
VALLEY SERIES-RIGID, ONE-PIECE LAPAROSCOPIC INSTRUMENTS	PAGE
INSULATED & CARBON FIBER HANDLES	12
NON-INSULTED HANDLES	13
5MM GRASPERS & DISSECTORS	14-26
5MM SCISSORS & BIOPSY FORCEPS	27-29
10MM GRASPERS & DISSECTORS	30-32
BASIN SERIES-ROTATABLE, ONE-PIECE LAPAROSCOPIC INSTRUMENTS	PAGE
INSULATED & CARBON FIBER HANDLES	34
NON-INSULTED HANDLES	35
5MM GRASPERS & DISSECTORS	36-48
5MM SCISSORS & BIOPSY FORCEPS	49-51
10MM GRASPERS & DISSECTORS	52-53
10MM SCISSORS & BIOPSY FORCEPS	54
SUMMIT SERIES-ROTATABLE, THREE-PIECE MODULAR LAPAROSCOPIC INSTRUMENTS	PAGE
SUMMIT SERIES OUTER TUBES & ACCESSORIES	56
INSULATED & CARBON FIBER HANDLES	57
NON-INSULTED HANDLES	58
5MM GRASPERS & DISSECTORS	59-72
5MM SCISSORS & BIOPSY FORCEPS	73-75
10MM GRASPERS & DISSECTORS	76-78
SURE GRIP SERIES: RIGID, ROTATABLE & MODULAR	PAGE
5MM SLIDE-LOCK HANDLE GRASPERS	80-86
DISPOSABLE & REPOSABLE SERIES	PAGE
REPOSABLE HANDLE & SHAFT W/ DISPOSABLE TIPS	88
REPOSABLE HANDLE & SHAFT W/ REPOSABLE TIPS	89

TRADITIONAL SERIES	PAGE
5MM TRADITIONAL LAPAROSCOPIC INSTRUMENTS	91-93
10MM TRADITIONAL LAPAROSCOPIC INSTRUMENTS	94
SUTURE & LIGATURE INSTRUMENTS	PAGE
ELMED LAPAROSCOPIC 5MM CLIP APPLIERS	96
ELMED LAPAROSCOPIC 10MM CLIP APPLIERS	97
ELMED LAPAROSCOPIC 5MM NEEDLE HOLDERS	98-100
ELMED MODULAR SCREW-APART LAPAROSCOPIC 5MM NEEDLE HOLDERS	101-105
NEEDLE HOLDERS	106
ELMED KNOT PUSHERS	107
SUTURE PASSER & STAINLESS STEEL TROCAR GUIDE CONES	108
SPECIALTY LAP INSTRUMENTS	PAGE
HASSON 3-PRONG GRASPER & MYOMA SCREW	110
CHOLANGIOGRAM CLAMP, ENDOSCOPIC MAGNETIC ROD, RETRACTABLE ENDOSCOPIC KNIFE	111
ATRAUMATIC LONG JAW CHOLANGIOGRAM CLAMP	112
SILASTIC RING APPLICATOR FOR TUBULAR STERILIZATION & COHEN CANNULA	113
UTERINE MANIPULATOR	114
UTERINE TENACULUM	115
ASPIRATION NEEDLES, VERESS NEEDLES	116
PALPITATION PROBES	116
SPECIALTY CANNULAS	117-118
SELF-RETAINING RETRACTOR SYSTEMS & MINIMAL INVASIVE RETRACTORS	PAGE
ELMED RETRACT ROBOT IN LAPAROSCOPIC SURGERY	120
ELMED GOOSE NECK RETRACT ROBOT IN LAPAROSCOPIC SURGERY	121
NATHANSON LIVER RETRACTORS	122-123
NATHANSON LIVER RETRACTORS FOR ROBOTIC USE	124
90° ARTICULATING FLAT BLADE RETRACTORS	125
LAP BANDING RETRACTORS W/ RATCHET HANDLE	126
SNAKE RETRACTORS	127
FAN, KITE RETRACTORS & MINIMALLY INVASIVE RETRACTORS/ELEVATORS	128
ELECTROSURGICAL UNITS FOR LAPAROSCOPY	PAGE
ESU 400 DIGITAL ELECTROSURGICAL UNIT –FOR LAPAROSCOPY & OTHER MINIMALLY INVASIVE PROCEDURES	130-131
ELMED LAPAROSCOPIC LBC 50-P DIGITAL BIPOLAR GENERATOR W/ INTEGRATED AMMETER, VISUAL COAGULATION INDICATOR AUTOMATIC SHUT-OFF	132
ELMED ARFM BIPOLAR LAPAROSCOPIC COAGULATION MONITOR	133

BIPOLAR LAP INSTRUMENTS	PAGE
THE ORIGINAL KLEPPINGER BIPOLAR LAPAROSCOPIC FORCEPS	135
ELMED KLEPPINGER TYPE III BIPOLAR LAPAROSCOPIC FORCEPS & REUSABLE REPLACEMENT TONGS	136
POWERGRIP BIPOLAR SCISSORS & FORCEPS	137
360° ROTATABLE ORBITARIS BIPOLAR SCISSORS & FORCEPS	138
POWERGRIP 3.0MM BIPOLAR DISSECTOR & GRASPER	139
CLASSIC BIPOLAR SCISSORS & FORCEPS	140
ELMED BIPOLAR TRIPLE-FUNCTION FORCEPS & BIPOLAR COAGULATION PROBES	141
3MM & 5MM LAPAROSCOPIC BIPOLAR ELECTRODES	142
REUSABLE CABLES FOR BIPOLAR INSTRUMENTS & GENERATORS	143
MONOPOLAR LAP INSTRUMENTS	PAGE
5MM DIAMETER MONOPOLAR ELECTRODES	145
5MM DIAMETER MONOPOLAR ELECTRODES– W/ SUCTION/IRRIGATION PORT	146
5MM DIAMETER MONOPOLAR ELECTRODES– FOR USE W/ HAND-SWITCHING HANDLES	146
ELMED RETRACTABLE NEEDLE ELECTRODES FOR PRECISE CUTTING & COAGULATION	147
REUSABLE CABLES FOR MONOPOLAR INSTRUMENTS & GENERATORS	148
IRRIGATION & SUCTION INSTRUMENTS	PAGE
IRRIGATION / SUCTION TUBES	150-152
IRRIGATION / SUCTION SYSTEMS	153
SINGLE TRUMPET OR PISTOL GRIP SUCTION / IRRIGATION SYSTEMS	154
TRIPLE FUNCTION SUCTION / IRRIGATION CANNULA	154
IRRIGATION / SUCTION TUBES FOR DISPOSABLE HANDLES	155-156
MONOPOLAR RF ELECTRODES FOR DISPOSABLE HANDLES	157
STORZ TYPE LAPAROSCOPIC ELECTRODES	158-159
TESTING, CLEANING, STERILIZATION & STORAGE	PAGE
ELMED ENDO-TEST UNITS FOR INSULATION TESTING	161
ELMED WATER JET CLEANING GUN, ULTRASTOP “PRO MED” ANTI-FOGGING AGENT, LUBRICATING OIL FOR SURGICAL INSTRUMENTS	162
CLEANING BRUSHES FOR ENDOSCOPIC INSTRUMENTS	163
STERILIZATION & STORAGE CONTAINERS FOR LAP INSTRUMENTS & SCOPES	164-166
SERVICE AND REPAIR	167

TROCARS CANNULAS & SCOPES



MINIMALLY INVASIVE SURGERY HAS RAPIDLY EXPANDED INTO NEW CLINICAL APPLICATIONS, CREATING THE NEED FOR INCREASINGLY ADVANCED SURGICAL INSTRUMENTS. THE USE OF HIGH-QUALITY HD LAPAROSCOPES, TROCARS, AND SLEEVES IS ESSENTIAL FOR PRECISION AND RELIABILITY DURING MULTI-PUNCTURE SURGICAL PROCEDURES.

ELMED MANUFACTURES A COMPREHENSIVE RANGE OF REUSABLE HD LAPAROSCOPES, TROCARS, AND SLEEVES THAT DELIVER BOTH SIGNIFICANT ECONOMIC ADVANTAGES AND TECHNOLOGICAL SUPERIORITY COMPARED TO DISPOSABLE SYSTEMS. EACH PRODUCT IS CRAFTED USING ONLY THE HIGHEST-GRADE MATERIALS AND EXCEPTIONAL MANUFACTURING EXPERTISE TO ENSURE OUTSTANDING PERFORMANCE, DURABILITY, AND CLINICAL CONFIDENCE.



ELMED EOS HD LAPAROSCOPES



MADE IN THE USA



ITEM NO.	SIZE	DESCRIPTION
52205-00	5MM X 26CM	0° LAPAROSCOPE, HD, AUTOCLAVABLE, COLOR CODE: BLUE
52205-01	5MM X 26CM	30° LAPAROSCOPE, HD, AUTOCLAVABLE, COLOR CODE: RED
52205-02	5MM X 30CM	0° LAPAROSCOPE, HD, AUTOCLAVABLE, COLOR CODE: BLUE
52205-03	5MM X 30CM	30° LAPAROSCOPE, HD, AUTOCLAVABLE, COLOR CODE: RED
52245-04	5MM X 30CM	45° LAPAROSCOPE, HD, AUTOCLAVABLE, COLOR CODE: BLACK
52215-00	5MM X 50CM	0° LAPAROSCOPE, HD, AUTOCLAVABLE, COLOR CODE: BLUE
52215-01	5MM X 50CM	30° LAPAROSCOPE, HD, AUTOCLAVABLE, COLOR CODE: RED
52215-02	5MM X 50CM	45° LAPAROSCOPE, HD, AUTOCLAVABLE, COLOR CODE: BLACK
52210-00	10MM X 30CM	0° LAPAROSCOPE, HD, AUTOCLAVABLE, COLOR CODE: BLUE
52210-01	10MM X 30CM	30° LAPAROSCOPE, HD, AUTOCLAVABLE, COLOR CODE: RED
52210-02	10MM X 30CM	45° LAPAROSCOPE, HD, AUTOCLAVABLE, COLOR CODE: BLACK
52515-00	10MM X 50CM	0° LAPAROSCOPE, HD, AUTOCLAVABLE, COLOR CODE: BLUE
52515-01	10MM X 50CM	30° LAPAROSCOPE, HD, AUTOCLAVABLE, COLOR CODE: RED
52515-02	10MM X 50CM	45° LAPAROSCOPE, HD, AUTOCLAVABLE, COLOR CODE: BLACK

ELMED TP4-OPTIC CLEAR TELESCOPE PRE-HEATER

TO PREVENT FOGGING OF THE OPTICAL SYSTEM ON ENDOSCOPES AT THE TIME OF INSERTION, PREHEATING HAS BEEN WIDELY ACCEPTED. WITH THE ELMED TP 11 TELESCOPE PREHEATER, WE PROVIDE A UNIQUE UNIT WITH VARIABLE TEMPERATURE RANGE AND DIGITAL READOUT.

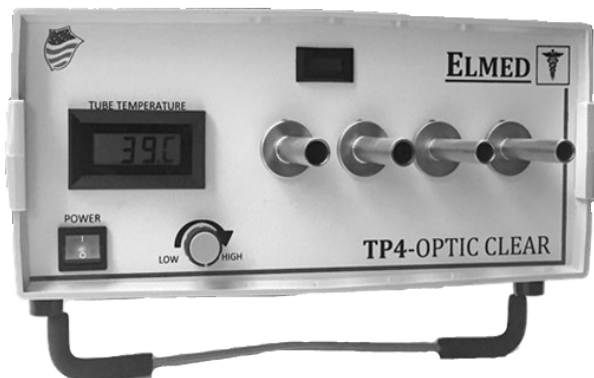

ITEM NO.	DESCRIPTION
52033-50	<i>ELMED TP 11 TELESCOPE PREHEATER INCLUDING (4) AUTOCLAVABLE TELESCOPE TUBES, STANDARD 10MM (QTY.2), 5MM (QTY.1), AND 4MM (QTY.1)</i>
52003-45-04	4MM DIA., REPLACEMENT TUBE
52003-45-05	5MM DIA., REPLACEMENT TUBE
52003-45-10	10MM DIA., REPLACEMENT TUBE

THIS UNIT CONNECTS TO ANY CONVENTIONAL OUTLET (115 V), OTHER VOLTAGES ARE AVAILABLE UPON REQUEST





ELMED EOS HD OPERATING LAPAROSCOPES



MADE IN THE USA

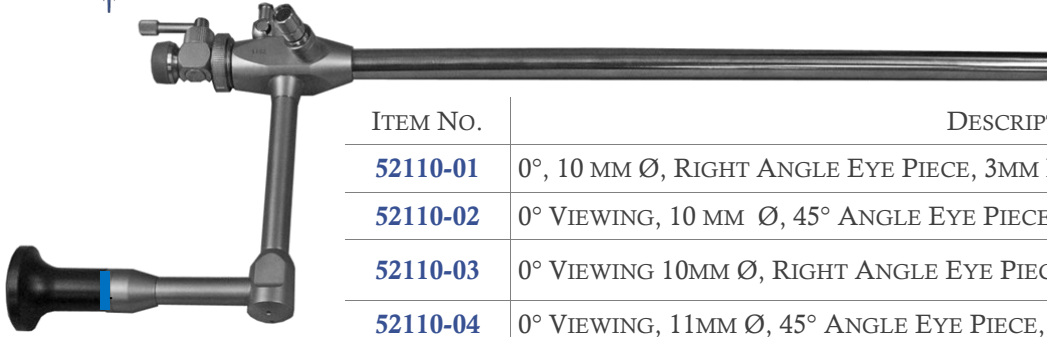

ITEM NO.	DESCRIPTION
52110-01	0°, 10 MM Ø, RIGHT ANGLE EYE PIECE, 3MM INSTRUMENT CHANNEL
52110-02	0° VIEWING, 10 MM Ø, 45° ANGLE EYE PIECE, 3MM INSTRUMENT CHANNEL.
52110-03	0° VIEWING 10MM Ø, RIGHT ANGLE EYE PIECE, 5.5MM INSTRUMENT CHANNEL
52110-04	0° VIEWING, 11MM Ø, 45° ANGLE EYE PIECE, 6MM INSTRUMENT CHANNEL
52110-05	0° VIEWING, 11MM Ø, RIGHT ANGLE EYE PIECE, 6 MM INSTRUMENT CHANNEL
52110-06	0° VIEWING, 12MM Ø, RIGHT ANGLE EYE PIECE, 7 MM INSTRUMENT CHANNEL
52110-07	0° VIEWING, 12MM Ø, 45° ANGLE EYE PIECE, 7 MM INSTRUMENT CHANNEL
52110-08	0° VIEWING, 10MM Ø, 45° ANGLE EYE PIECE, 5.5 MM INSTRUMENT CHANNEL

REPLACEMENT PARTS FOR ELMED EOS HD OPERATING LAPAROSCOPES

STOPCOCK ORDERING INFORMATION:

ITEM NO.	DESCRIPTION
52110-00-01	REPLACEMENT STOPCOCK AND INSTRUMENT CHANNEL SEAL: 3MM DIA., FOR ELMED SCOPES (#52110-01 & 52110-02)
52110-00-03	REPLACEMENT STOPCOCK AND INSTRUMENT CHANNEL SEAL: 5.5MM DIA., FOR ELMED SCOPES (#52110-03 & 52110-08)
52110-00-05	REPLACEMENT STOPCOCK AND INSTRUMENT CHANNEL SEAL: 6MM DIA., FOR ELMED SCOPES (#52110-04 & 52110-05)
52110-00-06	REPLACEMENT STOPCOCK AND INSTRUMENT CHANNEL SEAL: 7MM DIA., FOR ELMED SCOPES (#52110-06 & 52110-07)

SPECIAL PARTS & CLEANING BRUSHES ORDERING INFORMATION:

52110-20	ADAPTER FOR ACMI FALLOPIAN RING APPLICATOR FOR ELMED SCOPE #52110-06
52003-29	CLEANING BRUSH FOR OPERATING SCOPE WITH 3MM DIA. INSTRUMENT CHANNEL, 12/PKG.
52003-31	CLEANING BRUSH FOR OPERATING SCOPE WITH 5.5MM DIA. INSTRUMENT CHANNEL, 12/PKG.
52003-23	CLEANING BRUSH FOR OPERATING SCOPE WITH 6MM DIA. INSTRUMENT CHANNEL, 12/PKG.
52003-25	CLEANING BRUSH FOR OPERATING SCOPE WITH 7MM DIA. INSTRUMENT CHANNEL, 12/PKG.

SEALING CAP ORDERING INFORMATION:

52003-02	REPLACEMENT SEALING CAP FOR OPERATING SCOPE WITH 3MM DIA. INSTRUMENT CHANNEL, 12/PKG.
52003-04	REPLACEMENT SEALING CAP FOR OPERATING SCOPE WITH 5.5MM DIA. INSTRUMENT CHANNEL, 12/PKG.
52003-05	REPLACEMENT SEALING CAP FOR OPERATING SCOPE WITH 6MM DIA. INSTRUMENT CHANNEL, 12/PKG.
52003-06	REPLACEMENT SEALING CAP FOR OPERATING SCOPE WITH 7MM DIA. INSTRUMENT CHANNEL, 12/PKG.

PROTECTIVE RIGID SCOPE SHEATH

37000-19	19CM (7½")
-----------------	------------



WE DESIGN, MANUFACTURE & SELL THE TOOLS THE SURGEONS USE



ELMED “LITE” THERMOPLASTIC TROCAR SLEEVES









MADE IN THE USA



“LITE” THERMOPLASTIC , SMOOTH SLEEVE

“LITE” THERMOPLASTIC , THREADED SLEEVE

THERMOPLASTIC SMOOTH SLEEVE	DIAMETER	LENGTH	MATCHING TROCARS IN PYRAMIDAL, CONICAL OR CONICAL BLUNT STYLES		
					
52906-05	5MM	60MM	52960-05	52961-05	52962-05
52900-05	5MM	110MM	52901-05	52902-05	52903-05
52904-05	5MM	150MM	52921-05	52922-05	52923-05
52900-06	6MM	110MM	52901-06	52902-06	52903-06
52904-06	6MM	150MM	52921-06	52922-06	52923-06
52900-08	8MM	110MM	52901-08	52902-08	52903-08
52904-08	8MM	150MM	52921-08	52922-08	52923-08
52900-10	1MM	110MM	52901-10	52902-10	52903-10
52904-10	1MM	150MM	52921-10	52922-10	52923-10
52900-11	11MM	110MM	52901-11	52902-11	52903-11
52904-11	11MM	150MM	52921-11	52922-11	52923-11
52900-12	12MM	110MM	52901-12	52902-12	52903-12
52904-12	12MM	150MM	52921-12	52922-12	52923-12

THERMOPLASTIC THREADED SLEEVE	DIAMETER	LENGTH	MATCHING TROCARS IN PYRAMIDAL, CONICAL OR CONICAL BLUNT STYLES		
					
52906-05T	5MM	60MM	52960-05	52961-05	52962-05
52900-05T	5MM	110MM	52901-05	52902-05	52903-05
52904-05T	5MM	150MM	52921-05	52922-05	52923-05
52900-06T	6MM	110MM	52901-06	52902-06	52903-06
52904-06T	6MM	150MM	52921-06	52922-06	52923-06
52900-08T	8MM	110MM	52901-08	52902-08	52903-08
52904-08T	8MM	150MM	52921-08	52922-08	52923-08
52900-10T	1MM	110MM	52901-10	52902-10	52903-10
52904-10T	1MM	150MM	52921-10	52922-10	52923-10
52900-11T	11MM	110MM	52901-11	52902-11	52903-11
52904-11T	11MM	150MM	52921-11	52922-11	52923-11
52900-12T	12MM	110MM	52901-12	52902-12	52903-12
52904-12T	12MM	150MM	52921-12	52922-12	52923-12





REPLACEMENT ACCESSORIES FOR “LITE” TROCAR SLEEVES



MADE IN THE USA

DIAMETER	DESCRIPTION
52003-16	SEALING CAP FOR 15MM TROCAR SLEEVE, 10/PKG. (FIG.3)
52003-17	SEALING CAP FOR 6MM TROCAR SLEEVE, 10/PKG. (FIG.3)
52003-19	SEALING CAP FOR 8MM TROCAR SLEEVE, 10/PKG. (FIG.3)
52003-20	SEALING CAP FOR 10MM TROCAR SLEEVE, 10/PKG. (FIG.3)
52003-60	SEALING CAP FOR 11MM TROCAR SLEEVE, 10/PKG. (FIG.3)
52003-61	SEALING CAP FOR 12MM TROCAR SLEEVE, 10/PKG. (FIG.3)
52003-70	SILICONE RUBBER CAP WITH STRAP 10/PKG. (FIG. 4)
52900-01-10	REUSABLE SILICON VALVE- 3, 4, 5, 6MM DIA. (PKG 10) (FIG.1)
52900-02-10	REUSABLE SILICON VALVE- 7, 8, 10, 11, 12, 15MM DIA., (PKG. 10) (FIG.1)

*MINIMUM NUMBER OF PARTS=
SIMPLE TO CLEAN, SERVICE & ASSEMBLE*



REUSABLE SLIDE & FLIP TOP REDUCER FOR THE ELMED “LITE” TROCAR CANNULA SYSTEM



ITEM NO.	TRIPLE SLIDE REDUCER
52900-52	12MM TO 10/11MM TO 5MM



ITEM NO.	FLIP TOP REDUCER
52900-55	10/11MM TO 5MM
52900-56	12MM TO 5MM



ITEM NO.	DOUBLE SLIDE REDUCER
52900-51	11MM TO 5MM DIA.
52900-53	10MM TO 5MM DIA.
52900-54	12MM TO 5MM DIA.





ELMED LIGHTWEIGHT MAGNA-CLOSE TROCAR SLEEVES



MADE IN THE USA

THE MAGNA-CLOSE TROCAR SLEEVE IS LIGHT WEIGHT & THE SIMPLEST REUSABLE TROCAR SLEEVE TO SERVICE & CLEAN. IT CONSISTS OF THREE PIECES:

1. THE LOWER HOUSING CANNULA
2. THE UPPER HOUSING
3. THE VALVE PLATE: ELMED MAGNA-CLOSE TROCARS & SLEEVES FEATURE A LIGHTWEIGHT METAL TROCAR SLEEVES W/ MAGNETIC PLATE VALVE & INSUFFLATION PORT



LIGHTWEIGHT MAGNA-CLOSE SMOOTH SLEEVE

LIGHTWEIGHT MAGNA-CLOSE THREADED SLEEVE

STAINLESS STEEL SMOOTH SLEEVE W/ PORT	DIAMETER	LENGTH	MATCHING TROCARS IN PYRAMIDAL, CONICAL OR CONICAL BLUNT STYLES		
					
52205-113	5MM	110MM	52205-11	52205-12	52205-24
52205-213	5MM	150MM	52205-05	52205-04	52205-25
52206-113	6MM	110MM	52206-08	52206-12	52206-22
52206-213	6MM	150MM	52206-14	52206-15	52206-23
52208-113	8MM	110MM	52208-11	52208-12	52208-18
52208-213	8MM	150MM	52208-14	52208-15	52208-19
52210-113	10MM	110MM	52210-11	52110-12	52210-18
52210-213	10MM	150MM	52210-14	52210-15	52210-19
52211-113	11MM	110MM	52110-15	52110-16	52110-22
52211-213	11MM	150MM	52110-18	52110-19	52110-23
52212-113	12MM	110MM	52212-11	52212-12	52212-18
52212-213	12MM	150MM	52212-14	52212-15	52212-19

STAINLESS STEEL THREADED SLEEVE W/ PORT	DIAMETER	LENGTH	MATCHING TROCARS IN PYRAMIDAL, CONICAL OR CONICAL BLUNT STYLES		
					
52205-113T	5MM	110MM	52205-11	52205-12	52205-24
52205-213T	5MM	150MM	52205-05	52205-04	52205-25
52206-113T	6MM	110MM	52206-08	52206-12	52206-22
52206-213T	6MM	150MM	52206-14	52206-15	52206-23
52208-113T	8MM	110MM	52208-11	52208-12	52208-18
52208-213T	8MM	150MM	52208-14	52208-15	52208-19
52210-113T	10MM	110MM	52210-11	52110-12	52210-18
52210-213T	10MM	150MM	52210-14	52210-15	52210-19
52211-113T	11MM	110MM	52110-15	52110-16	52110-22
52211-213T	11MM	150MM	52110-18	52110-19	52110-23
52212-113T	12MM	110MM	52212-11	52212-12	52212-18
52212-213T	12MM	150MM	52212-14	52212-15	52212-19

REPLACEMENT SEALING CAPS

52003-50	SEALING CAP FOR 5MM MAGNA CLOSE TROCAR SLEEVE, 10/PKG.
52003-51	SEALING CAP FOR 8MM MAGNA CLOSE TROCAR SLEEVE, 10/PKG.
52003-52	SEALING CAP FOR 10MM MAGNA CLOSE TROCAR SLEEVE, 10/PKG.
52003-53	SEALING CAP FOR 11MM MAGNA CLOSE TROCAR SLEEVE, 10/PKG.



WE DESIGN, MANUFACTURE & SELL THE TOOLS THE SURGEONS USE



STAINLESS STEEL TROCAR SLEEVES W/ TRUMPET VALVE



MADE IN THE USA



STAINLESS STEEL SMOOTH SLEEVE W/
INSUFFLATION PORT

STAINLESS STEEL THREADED SLEEVE W/
INSUFFLATION PORT

STAINLESS STEEL SMOOTH SLEEVE W/ PORT	DIAMETER	LENGTH	MATCHING TROCARS IN PYRAMIDAL, CONICAL OR CONICAL BLUNT STYLES		
					
52205-09	5MM	110MM	52205-11	52205-12	52205-24
52205-08	5MM	150MM	52205-05	52205-04	52205-25
52206-10	6MM	110MM	52206-08	52206-12	52206-22
52206-13	6MM	150MM	52206-14	52206-15	52206-23
52208-10	8MM	110MM	52208-11	52208-12	52208-18
52208-13	8MM	150MM	52208-14	52208-15	52208-19
52210-10	10MM	110MM	52210-11	52110-12	52210-18
52210-13	10MM	150MM	52210-14	52210-15	52210-19
52211-14	11MM	110MM	52110-15	52110-16	52110-22
52211-17	11MM	150MM	52110-18	52110-19	52110-23
52212-10	12MM	110MM	52212-11	52212-12	52212-18
52212-13	12MM	150MM	52212-14	52212-15	52212-19

STAINLESS STEEL THREADED SLEEVE W/ PORT	DIAMETER	LENGTH	MATCHING TROCARS IN PYRAMIDAL, CONICAL OR CONICAL BLUNT STYLES		
					
52205-09T	5MM	110MM	52205-11	52205-12	52205-24
52205-08T	5MM	150MM	52205-05	52205-04	52205-25
52206-10T	6MM	110MM	52206-08	52206-12	52206-22
52206-13T	6MM	150MM	52206-14	52206-15	52206-23
52208-10T	8MM	110MM	52208-11	52208-12	52208-18
52208-13T	8MM	150MM	52208-14	52208-15	52208-19
52210-10T	10MM	110MM	52210-11	52110-12	52210-18
52210-13T	10MM	150MM	52210-14	52210-15	52210-19
52210-14T	11MM	110MM	52110-15	52110-16	52110-22
52210-17T	11MM	150MM	52110-18	52110-19	52110-23
52212-10T	12MM	110MM	52212-11	52212-12	52212-18
52212-13T	12MM	150MM	52212-14	52212-15	52212-19

REPLACEMENT SEALING CAPS

ITEM NO.	DESCRIPTION
52003-16	SEALING CAP FOR 15MM TROCAR SLEEVE, 10/PKG.
52003-17	SEALING CAP FOR 6MM TROCAR SLEEVE, 10/PKG.
52003-18	SEALING CAP FOR 7MM TROCAR SLEEVE, 10/PKG.
52003-19	SEALING CAP FOR 8MM TROCAR SLEEVE, 10/PKG.
52003-20	SEALING CAP FOR 10MM TROCAR SLEEVE, 10/PKG.
52003-60	SEALING CAP FOR 11MM TROCAR SLEEVE, 10/PKG.
52003-61	SEALING CAP FOR 12MM TROCAR SLEEVE, 10/PKG.



WE DESIGN, MANUFACTURE & SELL THE TOOLS THE SURGEONS USE



ELMED STAINLESS STEEL SAFETY TROCARS, SPRING LOADED



MADE IN THE USA

INNER CUTTING ASSEMBLY IS SPRING LOADED TO PROTECT CONTENTS OF THE ABDOMINAL CAVITY UPON PENETRATION



DIA.	STANDARD 110MM LENGTH	EXTRA LONG 150MM LENGTH
5MM	52205-112	52205-212
6MM	52206-112	52206-212
8MM	52208-112	52208-212
10MM	52210-112	52210-212
11MM	52211-112	52211-212
12MM	52212-112	52212-212



STYLE A: BLUNT OBTURATOR W/ OBLIQUE SAFETY SPRING LOADED CUTTING SHIELD

DILATION SETS-COMplete SLEEVE & PROBE



DIA.	STANDARD LENGTH
5-11MM	52001-22
10-15MM	52001-23

REDUCERS



DIA.	STANDARD REDUCER FOR FULL LENGTH OF SLEEVE	REDUCER W/ FLIP VALVE FOR SLEEVE TOP OPENING
5MM TO 3MM	52203-08-01	52205-80
12MM TO 5MM	52212-16	52212-80
10MM TO 5MM	52210-16	52210-80
11MM TO 5MM	52110-30	52210-80
12MM TO 5MM	52212-20	52212-81





ELMED HASSON CANNULA FOR OPEN LAPAROSCOPY



MADE IN THE USA

CLASSIC HASSON CANNULA

TRUMPET VALVE, INCLUDING TROCAR, SLEEVE & CONE SUTURE POST



DIA.	STANDARD LENGTH
5MM	52205-99
8MM	52208-99
10MM	52210-99
11MM	52110-99
12MM	52212-99

LIGHTWEIGHT HASSON CANNULA

MAGNA-CLOSE, INCLUDING TROCAR, SLEEVE & CONE SUTURE POST



DIA.	STANDARD LENGTH
5MM	52205-199
8MM	52208-199
10MM	52210-199
11MM	52110-199
12MM	52212-199

REPLACEMENT SEALING CAPS

ITEM No.	DESCRIPTION
52003-16	SEALING CAP FOR 5MM TROCAR SLEEVE, 10/PKG.
52003-19	SEALING CAP FOR 8MM TROCAR SLEEVE, 10/PKG.
52003-20	SEALING CAP FOR 10MM TROCAR SLEEVE, 10/PKG.
52003-60	SEALING CAP FOR 11MM TROCAR SLEEVE, 10/PKG.
52003-61	SEALING CAP FOR 12MM TROCAR SLEEVE, 10/PKG.
52003-9905	SEALING CAP FOR 5MM DIA. HASSON CANNULA CONE (10/PKG.)
52003-9908	SEALING CAP FOR 8MM DIA. HASSON CANNULA CONE (10/PKG.)
52003-9910	SEALING CAP FOR 10MM DIA. HASSON CANNULA CONE (10/PKG.)
52003-9911	SEALING CAP FOR 11MM DIA. HASSON CANNULA CONE (10/PKG.)
52003-9912	SEALING CAP FOR 12MM DIA. HASSON CANNULA CONE (10/PKG.)

HASSON "S-SHAPED" RETRACTORS

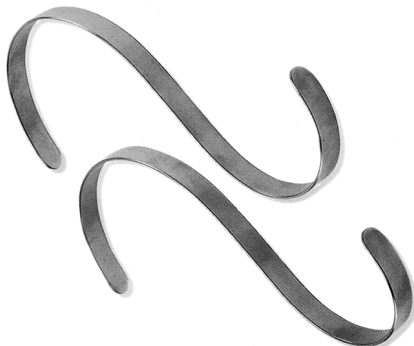

ITEM No.	DESCRIPTION
52110-98	HASSON S-SHAPED RETRACTOR, 3/8" (10MM BLADE WIDTH, SET OF 2)
52110-97	HASSON S-SHAPED RETRACTOR, 1/2" (10MM BLADE WIDTH, SET OF 2)
52110-96	HASSON S-SHAPED RETRACTOR, 3/4" (10MM BLADE WIDTH, SET OF 2)
52110-95	HASSON S-SHAPED RETRACTOR, 1" (10MM BLADE WIDTH, SET OF 2)

***CUSTOM WIDTHS AVAILABLE...PLEASE SPECIFY WHEN ORDERING



WE DESIGN, MANUFACTURE & SELL THE TOOLS THE SURGEONS USE



LAPAROSCOPIC ADAPTERS



MADE IN THE USA

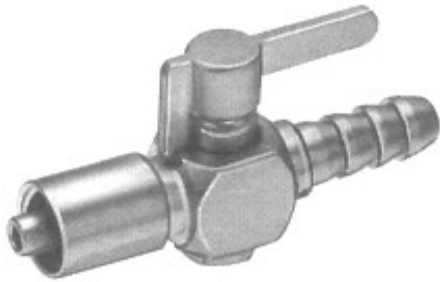

ITEM No.	DESCRIPTION
52000-32	STOPCOCK WITH MALE LUER LOCK & 6MM Ø BARB FITTING
52000-33	STOPCOCK WITH MALE LUER LOCK & 8MM Ø BARB FITTING

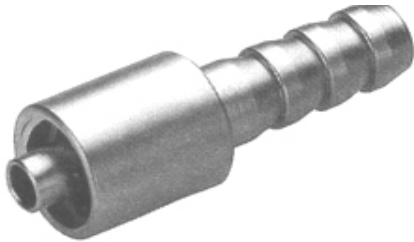

ITEM No.	DESCRIPTION
52000-16	MALE LUER LOCK 6MM Ø BARB HOSE END FITTING
52000-17	MALE LUER LOCK 8MM Ø BARB HOSE END FITTING



ITEM No.	DESCRIPTION
52000-18	FEMALE LUER LOCK 6MM Ø BARB HOSE END FITTING
52000-19	FEMALE LUER LOCK 8MM Ø BARB HOSE END FITTING



VALLEY SERIES



ONE PIECE RIGID LAPAROSCOPIC INSTRUMENTS

THE VALLEY SERIES 5MM & 10MM RIGID INSTRUMENTS ARE OUR **CLASSIC ONE-PIECE, NON-ROTATABLE** INSTRUMENTS WITH FLUSH PORTS FOR EASY CLEANING. ALL ARE AVAILABLE WITH ANY OF OUR SELECTION OF HANDLES.

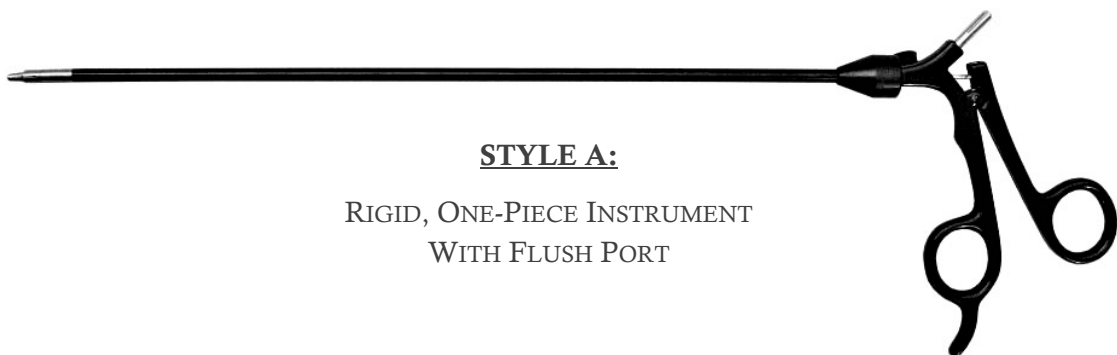

STYLE A:

RIGID, ONE-PIECE INSTRUMENT
WITH FLUSH PORT



HANDLES: NON CONDUCTIVE CARBON FIBER



MADE IN THE USA

52555-40-01

INSULATED STAINLESS STEEL W/ RF POST (TYPE 1)



52555-40-02

INSULATED STAINLESS STEEL W/ RF-POST & RATCHET (TYPE 2)



52555-40-05

INSULATED W/ RF-POST & RATCHET (TYPE 5)



52555-40-06

LIGHTWEIGHT CARBON FIBER W/ RF-POST & ON DEMAND ON/OFF RATCHET (TYPE 6)



52555-40-07

LIGHTWEIGHT CARBON-FIBER W/ RF POST, RATCHET / RATCHET DEFEATING (TYPE 7)



52555-40-08

LIGHTWEIGHT CARBON-FIBER W/ RF POST, ON DEMAND FRENCH ON/OFF RATCHET (TYPE 8)



52555-40-09

LIGHTWEIGHT CARBON-FIBER W/ RF POST, W/ LARGE FINGER LOOPS (TYPE 9)



52555-40-10

LIGHTWEIGHT CARBON-FIBER W/ RF POST, RATCHET / RATCHET DEFEATING W/ LARGE FINGER LOOPS (TYPE 10)



52555-40-14

INSULATED STAINLESS STEEL LINATEC-WECK STYLE W/ LONG SHANKS (TYPE 14)



52555-40-17

LIGHTWEIGHT THERMO-PLASTIC W/ RF POST (TYPE 17)



52555-40-18

LIGHTWEIGHT THERMO-PLASTIC W/ RF POST, RATCHET / RATCHET DEFEATING (TYPE 18)



52555-40-23

LIGHTWEIGHT THERMO-PLASTIC W/ RF POST, NON-RATCHET (TYPE 23)



52555-40-24

LIGHTWEIGHT THERMO-PLASTIC W/ RF POST, W/ RATCHET (TYPE 24)



WE DESIGN, MANUFACTURE & SELL THE TOOLS THE SURGEONS USE



HANDLES: NON-INSULATED



MADE IN THE USA

52555-40-03

NON-INSULATED , STAINLESS STEEL
(TYPE 3)



52555-40-04

NON-INSULATED STAINLESS STEEL
W/ RATCHET
(TYPE 4)



52555-40-11

NON-INSULATED RING AXIAL
HANDLE
(TYPE 11)



52555-40-12

NON-INSULATED RING
AXIAL HANDLE W/ RATCHET
(TYPE 12)



52555-40-13

STAINLESS STEEL AXIAL
HANDLE W/ PRECISE
ENGAGEMENT RATCHET
(TYPE 13)



52555-40-15

NON-INSULATED STAINLESS STEEL
LINVATEC-WECK STYLE W/ QUICK
RELEASE RATCHET & LONG SHANKS
(TYPE 15)



52555-40-16

NON-INSULATED STAINLESS STEEL
W/ SPRING ASSIST CLOSING
(TYPE 16)



52003-70

SILICONE RUBBER CAP WITH
STRAP
10/PKG



52555-40-21

STAINLESS STEEL AXIAL HANDLE
V-SHAPED W/ SPREADING
SPRING & THUMB RELEASE
RATCHET
(TYPE 21)



52555-40-30

STAINLESS STEEL AXIAL HANDLE
V-SHAPED W/ SPREADING
SPRING,
NON-RATCHET
(TYPE 30)



52555-40-19

STAINLESS STEEL AXIAL
HANDLE V-SHAPED, ANGLED
DOWN W/ SPREADING SPRING
& RATCHET
(TYPE 19)



52555-40-31

STAINLESS STEEL AXIAL
HANDLE V-SHAPED, ANGLED
DOWN W/ SPREADING
SPRING , NON RATCHET
(TYPE 31)



52555-40-26

ALUMINUM AXIAL HANDLE
SINGLE ACTION W/ RATCHET
(TYPE 26)



52555-40-28

ALUMINUM AXIAL HANDLE
SINGLE ACTION, NON-RATCHET
(TYPE 28)



52555-40-27

ALUMINUM AXIAL HANDLE,
ANGLED DOWN, SINGLE ACTION
W/ RATCHET
(TYPE 27)



52555-40-29

ALUMINUM AXIAL HANDLE,
ANGLED DOWN, SINGLE ACTION,
NON-RATCHET
(TYPE 29)





5MM DISSECTORS & GRASPERS



MADE IN THE USA

STYLE A
RIGID, ONE-PIECE INSTRUMENT
WITH FLUSH PORT



TIP ID & LENGTH	HANDLE		TYPE 1	TYPE 8	TYPE 9	TYPE 10	TYPE 17	TYPE 3	TYPE 4
	DIAMETER	LENGTH							
			INSULATED HANDLES					NON-INSULATED	
MICRO REDDICK OLSEN 12MM TIP 	5MM	24CM	52224-01A1	52224-01A8	52224-01A9	52224-01A10	52224-01A17	52224-01A3	52224-01A4
	5MM	33CM	52255-01A1	52255-01A8	52255-01A9	52255-01A10	52255-01A17	52255-01A3	52255-01A4
	5MM	36CM	52236-01A1	52236-01A8	52236-01A9	52236-01A10	52236-01A17	52236-01A3	52236-01A4
	5MM	45CM	52155-01A1	52155-01A8	52155-01A9	52155-01A10	52155-01A17	52155-01A3	52155-01A4
STANDARD GRASPER W/ SPOON 12MM TIP 	5MM	24CM	52224-02A1	52224-02A8	52224-02A9	52224-02A10	52224-02A17	52224-02A3	52224-02A4
	5MM	33CM	52255-02A1	52255-02A8	52255-02A9	52255-02A10	52255-02A17	52255-02A3	52255-02A4
	5MM	36CM	52236-02A1	52236-02A8	52236-02A9	52236-02A10	52236-02A17	52236-02A3	52236-02A4
	5MM	45CM	52155-02A1	52155-02A8	52155-02A9	52155-02A10	52155-02A17	52155-02A3	52155-02A4
STANDARD GRASPER W/ SPOON, LONG 20MM TIP 	5MM	24CM	52224-52A1	52224-52A8	52224-52A9	52224-52A10	52224-52A17	52224-52A3	52224-52A4
	5MM	33CM	52255-52A1	52255-52A8	52255-52A9	52255-52A10	52255-52A17	52255-52A3	52255-52A4
	5MM	36CM	52236-52A1	52236-52A8	52236-52A9	52236-52A10	52236-52A17	52236-52A3	52236-52A4
	5MM	45CM	52155-52A1	52155-52A8	52155-52A9	52155-52A10	52155-52A17	52155-52A3	52155-52A4
STANDARD GRASPER 12MM TIP 	5MM	24CM	52224-03A1	52224-03A8	52224-03A9	52224-03A10	52224-03A17	52224-03A3	52224-03A4
	5MM	33CM	52255-03A1	52255-03A8	52255-03A9	52255-03A10	52255-03A17	52255-03A3	52255-03A4
	5MM	36CM	52236-03A1	52236-03A8	52236-03A9	52236-03A10	52236-03A17	52236-03A3	52236-03A4
	5MM	45CM	52155-03A1	52155-03A8	52155-03A9	52155-03A10	52155-03A17	52155-03A3	52155-03A4
BULLET-NOSE GRASPER W/ SPOON 12MM TIP 	5MM	24CM	52224-04A1	52224-04A8	52224-04A9	52224-04A10	52224-04A17	52224-04A3	52224-04A4
	5MM	33CM	52255-04A1	52255-04A8	52255-04A9	52255-04A10	52255-04A17	52255-04A3	52255-04A4
	5MM	36CM	52236-04A1	52236-04A8	52236-04A9	52236-04A10	52236-04A17	52236-04A3	52236-04A4
	5MM	45CM	52155-04A1	52155-04A8	52155-04A9	52155-04A10	52155-04A17	52155-04A3	52155-04A4
TAPERED DOLPHIN-NOSE 15MM TIP 	5MM	24CM	52224-05A1	52224-05A8	52224-05A9	52224-05A10	52224-05A17	52224-05A3	52224-05A4
	5MM	33CM	52255-05A1	52255-05A8	52255-05A9	52255-05A10	52255-05A17	52255-05A3	52255-05A4
	5MM	36CM	52236-05A1	52236-05A8	52236-05A9	52236-05A10	52236-05A17	52236-05A3	52236-05A4
	5MM	45CM	52155-05A1	52155-05A8	52155-05A9	52155-05A10	52155-05A17	52155-05A3	52155-05A4
TAPERED DOLPHIN-NOSE W/ SPOON 15MM TIP 	5MM	24CM	52224-105A1	52224-105A8	52224-105A9	52224-105A10	52224-105A17	52224-105A3	52224-105A4
	5MM	33CM	52255-105A1	52255-105A8	52255-105A9	52255-105A10	52255-105A17	52255-105A3	52255-105A4
	5MM	36CM	52236-105A1	52236-105A8	52236-105A9	52236-105A10	52236-105A17	52236-105A3	52236-105A4
	5MM	45CM	52155-105A1	52155-105A8	52155-105A9	52155-105A10	52155-105A17	52155-105A3	52155-105A4





5MM DISSECTORS & GRASPERS



MADE IN THE USA



TIP ID & LENGTH	HANDLE		TYPE 1	TYPE 8	TYPE 9	TYPE 10	TYPE 17	TYPE 3	TYPE 4
	DIAMETER	LENGTH							
			INSULATED HANDLES					NON-INSULATED	
TAPERED DOLPHIN-NOSE W/ LONG SPOON 22MM TIP 	5MM	24CM	52224-205A1	52224-205A8	52224-205A9	52224-205A10	52224-205A17	52224-205A3	52224-205A4
	5MM	33CM	52255-205A1	52255-205A8	52255-205A9	52255-205A10	52255-205A17	52255-205A3	52255-205A4
	5MM	36CM	52236-205A1	52236-205A8	52236-205A9	52236-205A10	52236-205A17	52236-205A3	52236-205A4
	5MM	45CM	52155-205A1	52155-205A8	52155-205A9	52155-205A10	52155-205A17	52155-205A3	52155-205A4
MARYLAND DISSECTOR 18MM TIP 	5MM	24CM	52224-06A1	52224-06A8	52224-06A9	52224-06A10	52224-06A17	52224-06A3	52224-06A4
	5MM	33CM	52255-06A1	52255-06A8	52255-06A9	52255-06A10	52255-06A17	52255-06A3	52255-06A4
	5MM	36CM	52236-06A1	52236-06A8	52236-06A9	52236-06A10	52236-06A17	52236-06A3	52236-06A4
	5MM	45CM	52155-06A1	52155-06A8	52155-06A9	52155-06A10	52155-06A17	52155-06A3	52155-06A4
TAPERED MARYLAND DISSECTOR 18MM TIP 	5MM	24CM	52224-106A1	52224-106A8	52224-106A9	52224-106A10	52224-106A17	52224-106A3	52224-106A4
	5MM	33CM	52255-106A1	52255-106A8	52255-106A9	52255-106A10	52255-106A17	52255-106A3	52255-106A4
	5MM	36CM	52236-106A1	52236-106A8	52236-106A9	52236-106A10	52236-106A17	52236-106A3	52236-106A4
	5MM	45CM	52155-106A1	52155-106A8	52155-106A9	52155-106A10	52155-106A17	52155-106A3	52155-106A4
SHORT MARYLAND DISSECTOR 15MM TIP 	5MM	24CM	52224-206A1	52224-206A8	52224-206A9	52224-206A10	52224-206A17	52224-206A3	52224-206A4
	5MM	33CM	52255-206A1	52255-206A8	52255-206A9	52255-206A10	52255-206A17	52255-206A3	52255-206A4
	5MM	36CM	52236-206A1	52236-206A8	52236-206A9	52236-206A10	52236-206A17	52236-206A3	52236-206A4
	5MM	45CM	52155-206A1	52155-206A8	52155-206A9	52155-206A10	52155-206A17	52155-206A3	52155-206A4
RIGHT ANGLE MIXTER, LONG 22MM TIP 	5MM	24CM	52224-07A1	52224-07A8	52224-07A9	52224-07A10	52224-07A17	52224-07A3	52224-07A4
	5MM	33CM	52255-07A1	52255-07A8	52255-07A9	52255-07A10	52255-07A17	52255-07A3	52255-07A4
	5MM	36CM	52236-07A1	52236-07A8	52236-07A9	52236-07A10	52236-07A17	52236-07A3	52236-07A4
	5MM	45CM	52155-07A1	52155-07A8	52155-07A9	52155-07A10	52155-07A17	52155-07A3	52155-07A4
RIGHT ANGLE MIXTER, SHORT 2MM TIP 	5MM	24CM	52224-59A1	52224-59A8	52224-59A9	52224-59A10	52224-59A17	52224-59A3	52224-59A4
	5MM	33CM	52255-59A1	52255-59A8	52255-59A9	52255-59A10	52255-59A17	52255-59A3	52255-59A4
	5MM	36CM	52236-59A1	52236-59A8	52236-59A9	52236-59A10	52236-59A17	52236-59A3	52236-59A4
	5MM	45CM	52155-59A1	52155-59A8	52155-59A9	52155-59A10	52155-59A17	52155-59A3	52155-59A4
45° ANGLED MIXTER 20MM TIP 	5MM	24CM	52224-08A1	52224-08A8	52224-08A9	52224-08A10	52224-08A17	52224-08A3	52224-08A4
	5MM	33CM	52255-08A1	52255-08A8	52255-08A9	52255-08A10	52255-08A17	52255-08A3	52255-08A4
	5MM	36CM	52236-08A1	52236-08A8	52236-08A9	52236-08A10	52236-08A17	52236-08A3	52236-08A4
	5MM	45CM	52155-08A1	52155-08A8	52155-08A9	52155-08A10	52155-08A17	52155-08A3	52155-08A4





5MM DISSECTORS & GRASPERS



MADE IN THE USA



TIP ID & LENGTH	HANDLE		TYPE 1	TYPE 8	TYPE 9	TYPE 10	TYPE 17	TYPE 3	TYPE 4
	DIAMETER	LENGTH							
			INSULATED HANDLES					NON-INSULATED	
DUCKBILL GRASPER 12MM TIP 	5MM	24CM	52224-09A1	52224-09A8	52224-09A9	52224-09A10	52224-09A17	52224-09A3	52224-09A4
	5MM	33CM	52255-09A1	52255-09A8	52255-09A9	52255-09A10	52255-09A17	52255-09A3	52255-09A4
	5MM	36CM	52236-09A1	52236-09A8	52236-09A9	52236-09A10	52236-09A17	52236-09A3	52236-09A4
	5MM	45CM	52155-09A1	52155-09A8	52155-09A9	52155-09A10	52155-09A17	52155-09A3	52155-09A4
NEEDLE-NOSE GRASPER 20MM TIP 	5MM	24CM	52224-10A1	52224-10A8	52224-10A9	52224-10A10	52224-10A17	52224-10A3	52224-10A4
	5MM	33CM	52255-10A1	52255-10A8	52255-10A9	52255-10A10	52255-10A17	52255-10A3	52255-10A4
	5MM	36CM	52236-10A1	52236-10A8	52236-10A9	52236-10A10	52236-10A17	52236-10A3	52236-10A4
	5MM	45CM	52155-10A1	52155-10A8	52155-10A9	52155-10A10	52155-10A17	52155-10A3	52155-10A4
KELLY GRASPER 14MM TIP 	5MM	24CM	52224-11A1	52224-11A8	52224-11A9	52224-11A10	52224-11A17	52224-11A3	52224-11A4
	5MM	33CM	52255-11A1	52255-11A8	52255-11A9	52255-11A10	52255-11A17	52255-11A3	52255-11A4
	5MM	36CM	52236-11A1	52236-11A8	52236-11A9	52236-11A10	52236-11A17	52236-11A3	52236-11A4
	5MM	45CM	52155-11A1	52155-11A8	52155-11A9	52155-11A10	52155-11A17	52155-11A3	52155-11A4
RIGHT ANGLE, LONG REACH GRASPER 22MM TIP 	5MM	24CM	52224-53A1	52224-53A8	52224-53A9	52224-53A10	52224-53A17	52224-53A3	52224-53A4
	5MM	33CM	52255-53A1	52255-53A8	52255-53A9	52255-53A10	52255-53A17	52255-53A3	52255-53A4
	5MM	36CM	52236-53A1	52236-53A8	52236-53A9	52236-53A10	52236-53A17	52236-53A3	52236-53A4
	5MM	45CM	52155-53A1	52155-53A8	52155-53A9	52155-53A10	52155-53A17	52155-53A3	52155-53A4
PETELIN DISSECTOR, 60° ANGLE, SA 10MM TIP 	5MM	24CM	52224-12A1	52224-12A8	52224-12A9	52224-12A10	52224-12A17	52224-12A3	52224-12A4
	5MM	33CM	52255-12A1	52255-12A8	52255-12A9	52255-12A10	52255-12A17	52255-12A3	52255-12A4
	5MM	36CM	52236-12A1	52236-12A8	52236-12A9	52236-12A10	52236-12A17	52236-12A3	52236-12A4
	5MM	45CM	52155-12A1	52155-12A8	52155-12A9	52155-12A10	52155-12A17	52155-12A3	52155-12A4
PETELIN DISSECTOR, 30° ANGLE, SA 10MM TIP 	5MM	24CM	52224-13A1	52224-13A8	52224-13A9	52224-13A10	52224-13A17	52224-13A3	52224-13A4
	5MM	33CM	52255-13A1	52255-13A8	52255-13A9	52255-13A10	52255-13A17	52255-13A3	52255-13A4
	5MM	36CM	52236-13A1	52236-13A8	52236-13A9	52236-13A10	52236-13A17	52236-13A3	52236-13A4
	5MM	45CM	52155-13A1	52155-13A8	52155-13A9	52155-13A10	52155-13A17	52155-13A3	52155-13A4
PETELIN STRONG RIGHT ANGLE DISSECTOR 10MM TIP 	5MM	24CM	52224-113A1	52224-113A8	52224-113A9	52224-113A10	52224-113A17	52224-113A3	52224-113A4
	5MM	33CM	52255-113A1	52255-113A8	52255-113A9	52255-113A10	52255-113A17	52255-113A3	52255-113A4
	5MM	36CM	52236-113A1	52236-113A8	52236-113A9	52236-113A10	52236-113A17	52236-113A3	52236-113A4
	5MM	45CM	52155-113A1	52155-113A8	52155-113A9	52155-113A10	52155-113A17	52155-113A3	52155-113A4





5MM DISSECTORS & GRASPERS



MADE IN THE USA

STYLE A
RIGID, ONE-PIECE INSTRUMENT
WITH FLUSH PORT

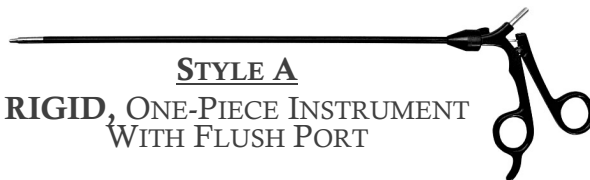

TIP ID & LENGTH	HANDLE		TYPE 1	TYPE 8	TYPE 9	TYPE 10	TYPE 17	TYPE 3	TYPE 4
	DIAMETER	LENGTH							
			INSULATED HANDLES					NON-INSULATED	
MICRO GRASPER, FENESTRATED 10MM TIP 	5MM	24CM	52224-14A1	52224-14A8	52224-14A9	52224-14A10	52224-14A17	52224-14A3	52224-14A4
	5MM	33CM	52255-14A1	52255-14A8	52255-14A9	52255-14A10	52255-14A17	52255-14A3	52255-14A4
	5MM	36CM	52236-14A1	52236-14A8	52236-14A9	52236-14A10	52236-14A17	52236-14A3	52236-14A4
	5MM	45CM	52155-14A1	52155-14A8	52155-14A9	52155-14A10	52155-14A17	52155-14A3	52155-14A4
COBRA GRASPER, DA 10MM TIP 	5MM	24CM	52224-15A1	52224-15A8	52224-15A9	52224-15A10	52224-15A17	52224-15A3	52224-15A4
	5MM	33CM	52255-15A1	52255-15A8	52255-15A9	52255-15A10	52255-15A17	52255-15A3	52255-15A4
	5MM	36CM	52236-15A1	52236-15A8	52236-15A9	52236-15A10	52236-15A17	52236-15A3	52236-15A4
	5MM	45CM	52155-15A1	52155-15A8	52155-15A9	52155-15A10	52155-15A17	52155-15A3	52155-15A4
BABCOCK GRASPER, FENESTRATED TIP 30MM TIP 	5MM	24CM	52224-16A1	52224-16A8	52224-16A9	52224-16A10	52224-16A17	52224-16A3	52224-16A4
	5MM	33CM	52255-16A1	52255-16A8	52255-16A9	52255-16A10	52255-16A17	52255-16A3	52255-16A4
	5MM	36CM	52236-16A1	52236-16A8	52236-16A9	52236-16A10	52236-16A17	52236-16A3	52236-16A4
	5MM	45CM	52155-16A1	52155-16A8	52155-16A9	52155-16A10	52155-16A17	52155-16A3	52155-16A4
BABCOCK, AXIS STYLE, FENESTRATED 30MM TIP 	5MM	24CM	52224-116A1	52224-116A8	52224-116A9	52224-116A10	52224-116A17	52224-116A3	52224-116A4
	5MM	33CM	52255-116A1	52255-116A8	52255-116A9	52255-116A10	52255-116A17	52255-116A3	52255-116A4
	5MM	36CM	52236-116A1	52236-116A8	52236-116A9	52236-116A10	52236-116A17	52236-116A3	52236-116A4
	5MM	45CM	52155-116A1	52155-116A8	52155-116A9	52155-116A10	52155-116A17	52155-116A3	52155-116A4
PADDLE BABCOCK GRASPER 30MM TIP 	5MM	24CM	52224-216A1	52224-216A8	52224-216A9	52224-216A10	52224-216A17	52224-216A3	52224-216A4
	5MM	33CM	52255-216A1	52255-216A8	52255-216A9	52255-216A10	52255-216A17	52255-216A3	52255-216A4
	5MM	36CM	52236-216A1	52236-216A8	52236-216A9	52236-216A10	52236-216A17	52236-216A3	52236-216A4
	5MM	45CM	52155-216A1	52155-216A8	52155-216A9	52155-216A10	52155-216A17	52155-216A3	52155-216A4
BABCOCK GRASPER, SHORT DELICATE 20MM TIP 	5MM	24CM	52224-17A1	52224-17A8	52224-17A9	52224-17A10	52224-17A17	52224-17A3	52224-17A4
	5MM	33CM	52255-17A1	52255-17A8	52255-17A9	52255-17A10	52255-17A17	52255-17A3	52255-17A4
	5MM	36CM	52236-17A1	52236-17A8	52236-17A9	52236-17A10	52236-17A17	52236-17A3	52236-17A4
	5MM	45CM	52155-17A1	52155-17A8	52155-17A9	52155-17A10	52155-17A17	52155-17A3	52155-17A4
ALLIS GRASPER, SHORT VERSION, SA 15MM TIP 	5MM	24CM	52224-18A1	52224-18A8	52224-18A9	52224-18A10	52224-18A17	52224-18A3	52224-18A4
	5MM	33CM	52255-18A1	52255-18A8	52255-18A9	52255-18A10	52255-18A17	52255-18A3	52255-18A4
	5MM	36CM	52236-18A1	52236-18A8	52236-18A9	52236-18A10	52236-18A17	52236-18A3	52236-18A4
	5MM	45CM	52155-18A1	52155-18A8	52155-18A9	52155-18A10	52155-18A17	52155-18A3	52155-18A4





5MM DISSECTORS & GRASPERS



MADE IN THE USA

STYLE A
RIGID, ONE-PIECE INSTRUMENT
WITH FLUSH PORT



TIP ID & LENGTH	HANDLE ID		TYPE 1	TYPE 8	TYPE 9	TYPE 10	TYPE 17	TYPE 3	TYPE 4
	DIAMETER	LENGTH							
			INSULATED HANDLES					NON-INSULATED	
ALLIS, SHORT VERSION, 3X4 TEETH, SERRATED 12MM TIP 	5MM	24CM	52224-19A1	52224-19A8	52224-19A9	52224-19A10	52224-19A17	52224-19A3	52224-19A4
	5MM	33CM	52255-19A1	52255-19A8	52255-19A9	52255-19A10	52255-19A17	52255-19A3	52255-19A4
	5MM	36CM	52236-19A1	52236-19A8	52236-19A9	52236-19A10	52236-19A17	52236-19A3	52236-19A4
	5MM	45CM	52155-19A1	52155-19A8	52155-19A9	52155-19A10	52155-19A17	52155-19A3	52155-19A4
ALLIS, SHORT VERSION, DBL ROW OF TEETH, SERRATED 12MM TIP 	5MM	24CM	52224-119A1	52224-119A8	52224-119A9	52224-119A10	52224-119A17	52224-119A3	52224-119A4
	5MM	33CM	52255-119A1	52255-119A8	52255-119A9	52255-119A10	52255-119A17	52255-119A3	52255-119A4
	5MM	36CM	52236-119A1	52236-119A8	52236-119A9	52236-119A10	52236-119A17	52236-119A3	52236-119A4
	5MM	45CM	52155-119A1	52155-119A8	52155-119A9	52155-119A10	52155-119A17	52155-119A3	52155-119A4
ALLIS, LONG, DBL ROW OF TEETH, SERRATED 25MM TIP 	5MM	24CM	52224-219A1	52224-219A8	52224-219A9	52224-219A10	52224-219A17	52224-219A3	52224-219A4
	5MM	33CM	52255-219A1	52255-219A8	52255-219A9	52255-219A10	52255-219A17	52255-219A3	52255-219A4
	5MM	36CM	52236-219A1	52236-219A8	52236-219A9	52236-219A10	52236-219A17	52236-219A3	52236-219A4
	5MM	45CM	52155-219A1	52155-219A8	52155-219A9	52155-219A10	52155-219A17	52155-219A3	52155-219A4
ALLIS GRASPER, MEDIUM, WECK STYLE 20MM TIP 	5MM	24CM	52224-20A1	52224-20A8	52224-20A9	52224-20A10	52224-20A17	52224-20A3	52224-20A4
	5MM	33CM	52255-20A1	52255-20A8	52255-20A9	52255-20A10	52255-20A17	52255-20A3	52255-20A4
	5MM	36CM	52236-20A1	52236-20A8	52236-20A9	52236-20A10	52236-20A17	52236-20A3	52236-20A4
	5MM	45CM	52155-20A1	52155-20A8	52155-20A9	52155-20A10	52155-20A17	52155-20A3	52155-20A4
ALLIS GRASPER, STD. VERSION 30MM TIP 	5MM	24CM	52224-21A1	52224-21A8	52224-21A9	52224-21A10	52224-21A17	52224-21A3	52224-21A4
	5MM	33CM	52255-21A1	52255-21A8	52255-21A9	52255-21A10	52255-21A17	52255-21A3	52255-21A4
	5MM	36CM	52236-21A1	52236-21A8	52236-21A9	52236-21A10	52236-21A17	52236-21A3	52236-21A4
	5MM	45CM	52155-21A1	52155-21A8	52155-21A9	52155-21A10	52155-21A17	52155-21A3	52155-21A4
ALLIS GRASPER, TC, STD. VERSION 35MM TIP 	5MM	24CM	52224-57A1	52224-57A8	52224-57A9	52224-57A10	52224-57A17	52224-57A3	52224-57A4
	5MM	33CM	52255-57A1	52255-57A8	52255-57A9	52255-57A10	52255-57A17	52255-57A3	52255-57A4
	5MM	36CM	52236-57A1	52236-57A8	52236-57A9	52236-57A10	52236-57A17	52236-57A3	52236-57A4
	5MM	45CM	52155-57A1	52155-57A8	52155-57A9	52155-57A10	52155-57A17	52155-57A3	52155-57A4
DEBAKEY GRASPER 20MM TIP 	5MM	24CM	52224-22A1	52224-22A8	52224-22A9	52224-22A10	52224-22A17	52224-22A3	52224-22A4
	5MM	33CM	52255-22A1	52255-22A8	52255-22A9	52255-22A10	52255-22A17	52255-22A3	52255-22A4
	5MM	36CM	52236-22A1	52236-22A8	52236-22A9	52236-22A10	52236-22A17	52236-22A3	52236-22A4
	5MM	45CM	52155-22A1	52155-22A8	52155-22A9	52155-22A10	52155-22A17	52155-22A3	52155-22A4





5MM DISSECTORS & GRASPERS



MADE IN THE USA

STYLE A
RIGID, ONE-PIECE INSTRUMENT
WITH FLUSH PORT



TIP ID & LENGTH	HANDLE		TYPE 1	TYPE 8	TYPE 9	TYPE 10	TYPE 17	TYPE 3	TYPE 4
	DIAMETER	LENGTH							
			INSULATED HANDLES					NON-INSULATED	
DEBAKEY GRASPER 34MM TIP 	5MM	24CM	52224-222A1	52224-222A8	52224-222A9	52224-222A10	52224-222A17	52224-222A3	52224-222A4
	5MM	33CM	52255-222A1	52255-222A8	52255-222A9	52255-222A10	52255-222A17	52255-222A3	52255-222A4
	5MM	36CM	52236-222A1	52236-222A8	52236-222A9	52236-222A10	52236-222A17	52236-222A3	52236-222A4
	5MM	45CM	52155-222A1	52155-222A8	52155-222A9	52155-222A10	52155-222A17	52155-222A3	52155-222A4
DEBAKEY GRAPER 40MM TIP 	5MM	24CM	52224-23A1	52224-23A8	52224-23A9	52224-23A10	52224-23A17	52224-23A3	52224-23A4
	5MM	33CM	52255-23A1	52255-23A8	52255-23A9	52255-23A10	52255-23A17	52255-23A3	52255-23A4
	5MM	36CM	52236-23A1	52236-23A8	52236-23A9	52236-23A10	52236-23A17	52236-23A3	52236-23A4
	5MM	45CM	52155-23A1	52155-23A8	52155-23A9	52155-23A10	52155-23A17	52155-23A3	52155-23A4
DEBAKEY GRASPER 60MM TIP 	5MM	24CM	52224-160A1	52224-160A8	52224-160A9	52224-160A10	52224-160A17	52224-160A3	52224-160A4
	5MM	33CM	52255-160A1	52255-160A8	52255-160A9	52255-160A10	52255-160A17	52255-160A3	52255-160A4
	5MM	36CM	52236-160A1	52236-160A8	52236-160A9	52236-160A10	52236-160A17	52236-160A3	52236-160A4
	5MM	45CM	52155-160A1	52155-160A8	52155-160A9	52155-160A10	52155-160A17	52155-160A3	52155-160A4
HUNTER DEBAKEY, FENESTRATED 16MM TIP 	5MM	24CM	52224-158A1	52224-158A8	52224-158A9	52224-158A10	52224-158A17	52224-158A3	52224-158A4
	5MM	33CM	52255-158A1	52255-158A8	52255-158A9	52255-158A10	52255-158A17	52255-158A3	52255-158A4
	5MM	36CM	52236-158A1	52236-158A8	52236-158A9	52236-158A10	52236-158A17	52236-158A3	52236-158A4
	5MM	45CM	52155-158A1	52155-158A8	52155-158A9	52155-158A10	52155-158A17	52155-158A3	52155-158A4
HUNTER DEBAKEY, FENESTRATED 20MM TIP 	5MM	24CM	52224-58A1	52224-58A8	52224-58A9	52224-58A10	52224-58A17	52224-58A3	52224-58A4
	5MM	33CM	52255-58A1	52255-58A8	52255-58A9	52255-58A10	52255-58A17	52255-58A3	52255-58A4
	5MM	36CM	52236-58A1	52236-58A8	52236-58A9	52236-58A10	52236-58A17	52236-58A3	52236-58A4
	5MM	45CM	52155-58A1	52155-58A8	52155-58A9	52155-58A10	52155-58A17	52155-58A3	52155-58A4
HUNTER DEBAKEY, FENESTRATED 40MM TIP 	5MM	24CM	52224-159A1	52224-159A8	52224-159A9	52224-159A10	52224-159A17	52224-159A3	52224-159A4
	5MM	33CM	52255-159A1	52255-159A8	52255-159A9	52255-159A10	52255-159A17	52255-159A3	52255-159A4
	5MM	36CM	52236-159A1	52236-159A8	52236-159A9	52236-159A10	52236-159A17	52236-159A3	52236-159A4
	5MM	45CM	52155-159A1	52155-159A8	52155-159A9	52155-159A10	52155-159A17	52155-159A3	52155-159A4
HUNTER DEBAKEY, FENESTRATED 60MM TIP 	5MM	24CM	52224-160A1	52224-160A8	52224-160A9	52224-160A10	52224-160A17	52224-160A3	52224-160A4
	5MM	33CM	52255-160A1	52255-160A8	52255-160A9	52255-160A10	52255-160A17	52255-160A3	52255-160A4
	5MM	36CM	52236-160A1	52236-160A8	52236-160A9	52236-160A10	52236-160A17	52236-160A3	52236-160A4
	5MM	45CM	52155-160A1	52155-160A8	52155-160A9	52155-160A10	52155-160A17	52155-160A3	52155-160A4





5MM DISSECTORS & GRASPERS



MADE IN THE USA

STYLE A
RIGID, ONE-PIECE INSTRUMENT
WITH FLUSH PORT



TIP ID & LENGTH	HANDLE ID		TYPE 1	TYPE 8	TYPE 9	TYPE 10	TYPE 17	TYPE 3	TYPE 4
	DIAMETER	LENGTH							
			INSULATED HANDLES					NON-INSULATED	
DEBAKEY GRASPER, CURVED 30MM TIP 	5MM	24CM	52224-46A1	52224-46A8	52224-46A9	52224-46A10	52224-46A17	52224-46A3	52224-46A4
	5MM	33CM	52255-46A1	52255-46A8	52255-46A9	52255-46A10	52255-46A17	52255-46A3	52255-46A4
	5MM	36CM	52236-46A1	52236-46A8	52236-46A9	52236-46A10	52236-46A17	52236-46A3	52236-46A4
	5MM	45CM	52155-46A1	52155-46A8	52155-46A9	52155-46A10	52155-46A17	52155-46A3	52155-46A4
DEBAKEY MARYLAND GRASPER 35MM TIP 	5MM	24CM	52224-149A1	52224-149A8	52224-149A9	52224-149A10	52224-149A17	52224-149A3	52224-149A4
	5MM	33CM	52255-149A1	52255-149A8	52255-149A9	52255-149A10	52255-149A17	52255-149A3	52255-149A4
	5MM	36CM	52236-149A1	52236-149A8	52236-149A9	52236-149A10	52236-149A17	52236-149A3	52236-149A4
	5MM	45CM	52155-149A1	52155-149A8	52155-149A9	52155-149A10	52155-149A17	52155-149A3	52155-149A4
GLASSMAN ATRAUMATIC GRASPER 30MM TIP 	5MM	24CM	52224-24A1	52224-24A8	52224-24A9	52224-24A10	52224-24A17	52224-24A3	52224-24A4
	5MM	33CM	52255-24A1	52255-24A8	52255-24A9	52255-24A10	52255-24A17	52255-24A3	52255-24A4
	5MM	36CM	52236-24A1	52236-24A8	52236-24A9	52236-24A10	52236-24A17	52236-24A3	52236-24A4
	5MM	45CM	52155-24A1	52155-24A8	52155-24A9	52155-24A10	52155-24A17	52155-24A3	52155-24A4
GRASPER, CROSS SERRATED, SA 10MM TIP 	5MM	24CM	52224-25A1	52224-25A8	52224-25A9	52224-25A10	52224-25A17	52224-25A3	52224-25A4
	5MM	33CM	52255-25A1	52255-25A8	52255-25A9	52255-25A10	52255-25A17	52255-25A3	52255-25A4
	5MM	36CM	52236-25A1	52236-25A8	52236-25A9	52236-25A10	52236-25A17	52236-25A3	52236-25A4
	5MM	45CM	52155-25A1	52155-25A8	52155-25A9	52155-25A10	52155-25A17	52155-25A3	52155-25A4
DBL. CUP FUNDUS MAXI GRASPER 16MM TIP 	5MM	24CM	52224-26A1	52224-26A8	52224-26A9	52224-26A10	52224-26A17	52224-26A3	52224-26A4
	5MM	33CM	52255-26A1	52255-26A8	52255-26A9	52255-26A10	52255-26A17	52255-26A3	52255-26A4
	5MM	36CM	52236-26A1	52236-26A8	52236-26A9	52236-26A10	52236-26A17	52236-26A3	52236-26A4
	5MM	45CM	52155-26A1	52155-26A8	52155-26A9	52155-26A10	52155-26A17	52155-26A3	52155-26A4
FENESTRATED DBL. FUNDUS GRASPER 16MM TIP 	5MM	24CM	52224-226A1	52224-226A8	52224-226A9	52224-226A10	52224-226A17	52224-226A3	52224-226A4
	5MM	33CM	52255-226A1	52255-226A8	52255-226A9	52255-226A10	52255-226A17	52255-226A3	52255-226A4
	5MM	36CM	52236-226A1	52236-226A8	52236-226A9	52236-226A10	52236-226A17	52236-226A3	52236-226A4
	5MM	45CM	52155-226A1	52155-226A8	52155-226A9	52155-226A10	52155-226A17	52155-226A3	52155-226A4
"MCKERNAN" STYLE FUNDUS GRASPER 16MM TIP 	5MM	24CM	52224-126A1	52224-126A8	52224-126A9	52224-126A10	52224-126A17	52224-126A3	52224-126A4
	5MM	33CM	52255-126A1	52255-126A8	52255-126A9	52255-126A10	52255-126A17	52255-126A3	52255-126A4
	5MM	36CM	52236-126A1	52236-126A8	52236-126A9	52236-126A10	52236-126A17	52236-126A3	52236-126A4
	5MM	45CM	52155-126A1	52155-126A8	52155-126A9	52155-126A10	52155-126A17	52155-126A3	52155-126A4

















5MM DISSECTORS & GRASPERS

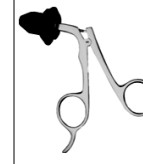
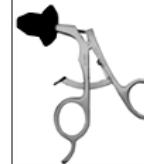

MADE IN THE USA

STYLE A
RIGID, ONE-PIECE INSTRUMENT
WITH FLUSH PORT



TIP ID & LENGTH	HANDLE ID		TYPE 1	TYPE 8	TYPE 9	TYPE 10	TYPE 17	TYPE 3	TYPE 4
	DIAMETER	LENGTH							
			INSULATED HANDLES					NON-INSULATED	
"WINER" STYLE FUNDUS GRASPER 16MM TIP 	5MM	24CM	52224-326A1	52224-326A8	52224-326A9	52224-326A10	52224-326A17	52224-326A3	52224-326A4
	5MM	33CM	52255-326A1	52255-326A8	52255-326A9	52255-326A10	52255-326A17	52255-326A3	52255-326A4
	5MM	36CM	52236-326A1	52236-326A8	52236-326A9	52236-326A10	52236-326A17	52236-326A3	52236-326A4
	5MM	45CM	52155-326A1	52155-326A8	52155-326A9	52155-326A10	52155-326A17	52155-326A3	52155-326A4
"JARIT STYLE" GRASPING FORCEPS DUAL CUP 16MM TIP 	5MM	24CM	52224-426A1	52224-426A8	52224-426A9	52224-426A10	52224-426A17	52224-426A3	52224-426A4
	5MM	33CM	52255-426A1	52255-426A8	52255-426A9	52255-426A10	52255-426A17	52255-426A3	52255-426A4
	5MM	36CM	52236-426A1	52236-426A8	52236-426A9	52236-426A10	52236-426A17	52236-426A3	52236-426A4
	5MM	45CM	52155-426A1	52155-426A8	52155-426A9	52155-426A10	52155-426A17	52155-426A3	52155-426A4
ENDOCLINCH FENESTRATED GRASPER 20MM TIP 	5MM	24CM	52224-27A1	52224-27A8	52224-27A9	52224-27A10	52224-27A17	52224-27A3	52224-27A4
	5MM	33CM	52255-27A1	52255-27A8	52255-27A9	52255-27A10	52255-27A17	52255-27A3	52255-27A4
	5MM	36CM	52236-27A1	52236-27A8	52236-27A9	52236-27A10	52236-27A17	52236-27A3	52236-27A4
	5MM	45CM	52155-27A1	52155-27A8	52155-27A9	52155-27A10	52155-27A17	52155-27A3	52155-27A4
RETRO-FACING, RAT TOOTH W/ CUP 10MM TIP 	5MM	24CM	52224-28A1	52224-28A8	52224-28A9	52224-28A10	52224-28A17	52224-28A3	52224-28A4
	5MM	33CM	52255-28A1	52255-28A8	52255-28A9	52255-28A10	52255-28A17	52255-28A3	52255-28A4
	5MM	36CM	52236-28A1	52236-28A8	52236-28A9	52236-28A10	52236-28A17	52236-28A3	52236-28A4
	5MM	45CM	52155-28A1	52155-28A8	52155-28A9	52155-28A10	52155-28A17	52155-28A3	52155-28A4
ALLIGATOR GRASPER, RETRO -FACING TEETH, DA 10MM TIP 	5MM	24CM	52224-29A1	52224-29A8	52224-29A9	52224-29A10	52224-29A17	52224-29A3	52224-29A4
	5MM	33CM	52255-29A1	52255-29A8	52255-29A9	52255-29A10	52255-29A17	52255-29A3	52255-29A4
	5MM	36CM	52236-29A1	52236-29A8	52236-29A9	52236-29A10	52236-29A17	52236-29A3	52236-29A4
	5MM	45CM	52155-29A1	52155-29A8	52155-29A9	52155-29A10	52155-29A17	52155-29A3	52155-29A4
ALLIGATOR GRASPER, RETRO -FACING TEETH, DA 20MM TIP 	5MM	24CM	52224-129A1	52224-129A8	52224-129A9	52224-129A10	52224-129A17	52224-129A3	52224-129A4
	5MM	33CM	52255-129A1	52255-129A8	52255-129A9	52255-129A10	52255-129A17	52255-129A3	52255-129A4
	5MM	36CM	52236-129A1	52236-129A8	52236-129A9	52236-129A10	52236-129A17	52236-129A3	52236-129A4
	5MM	45CM	52155-129A1	52155-129A8	52155-129A9	52155-129A10	52155-129A17	52155-129A3	52155-129A4
ALLIGATOR GRASPER, RETRO -FACING TEETH, SA 10MM TIP 	5MM	24CM	52224-30A1	52224-30A8	52224-30A9	52224-30A10	52224-30A17	52224-30A3	52224-30A4
	5MM	33CM	52255-30A1	52255-30A8	52255-30A9	52255-30A10	52255-30A17	52255-30A3	52255-30A4
	5MM	36CM	52236-30A1	52236-30A8	52236-30A9	52236-30A10	52236-30A17	52236-30A3	52236-30A4
	5MM	45CM	52155-30A1	52155-30A8	52155-30A9	52155-30A10	52155-30A17	52155-30A3	52155-30A4





5MM DISSECTORS & GRASPERS



MADE IN THE USA



TIP ID & LENGTH	HANDLE ID		TYPE 1	TYPE 8	TYPE 9	TYPE 10	TYPE 17	TYPE 3	TYPE 4
	DIAMETER	LENGTH							
			INSULATED HANDLES					NON-INSULATED	
CUP SHAPED GRASPER, W/ RETRO-FACING TEETH 10MM TIP 	5MM	24CM	52224-31A1	52224-31A8	52224-31A9	52224-31A10	52224-31A17	52224-31A3	52224-31A4
	5MM	33CM	52255-31A1	52255-31A8	52255-31A9	52255-31A10	52255-31A17	52255-31A3	52255-31A4
	5MM	36CM	52236-31A1	52236-31A8	52236-31A9	52236-31A10	52236-31A17	52236-31A3	52236-31A4
	5MM	45CM	52155-31A1	52155-31A8	52155-31A9	52155-31A10	52155-31A17	52155-31A3	52155-31A4
WAVE GRASPER, LONG BEVELED EDGE, DA 22MM TIP 	5MM	24CM	52224-32A1	52224-32A8	52224-32A9	52224-32A10	52224-32A17	52224-32A3	52224-32A4
	5MM	33CM	52255-32A1	52255-32A8	52255-32A9	52255-32A10	52255-32A17	52255-32A3	52255-32A4
	5MM	36CM	52236-32A1	52236-32A8	52236-32A9	52236-32A10	52236-32A17	52236-32A3	52236-32A4
	5MM	45CM	52155-32A1	52155-32A8	52155-32A9	52155-32A10	52155-32A17	52155-32A3	52155-32A4
WAVE GRASPER, LONG BEVELED EDGE, SA 22MM TIP 	5MM	24CM	52224-33A1	52224-33A8	52224-33A9	52224-33A10	52224-33A17	52224-33A3	52224-33A4
	5MM	33CM	52255-33A1	52255-33A8	52255-33A9	52255-33A10	52255-33A17	52255-33A3	52255-33A4
	5MM	36CM	52236-33A1	52236-33A8	52236-33A9	52236-33A10	52236-33A17	52236-33A3	52236-33A4
	5MM	45CM	52155-33A1	52155-33A8	52155-33A9	52155-33A10	52155-33A17	52155-33A3	52155-33A4
RETRACTION GRASPER, 2 X 3 TEETH, COBRA STYLE, DA 20MM TIP 	5MM	24CM	52224-34A1	52224-34A8	52224-34A9	52224-34A10	52224-34A17	52224-34A3	52224-34A4
	5MM	33CM	52255-34A1	52255-34A8	52255-34A9	52255-34A10	52255-34A17	52255-34A3	52255-34A4
	5MM	36CM	52236-34A1	52236-34A8	52236-34A9	52236-34A10	52236-34A17	52236-34A3	52236-34A4
	5MM	45CM	52155-34A1	52155-34A8	52155-34A9	52155-34A10	52155-34A17	52155-34A3	52155-34A4
RETRACTION GRASPER, 2 X 3 TEETH, COBRA STYLE, SA 20MM TIP 	5MM	24CM	52224-35A1	52224-35A8	52224-35A9	52224-35A10	52224-35A17	52224-35A3	52224-35A4
	5MM	33CM	52255-35A1	52255-35A8	52255-35A9	52255-35A10	52255-35A17	52255-35A3	52255-35A4
	5MM	36CM	52236-35A1	52236-35A8	52236-35A9	52236-35A10	52236-35A17	52236-35A3	52236-35A4
	5MM	45CM	52155-35A1	52155-35A8	52155-35A9	52155-35A10	52155-35A17	52155-35A3	52155-35A4
RETRACTION GRASPER, 2 X 3 TEETH, JARIT STYLE, DA 20MM TIP 	5MM	24CM	52224-134A1	52224-134A8	52224-134A9	52224-134A10	52224-134A17	52224-134A3	52224-134A4
	5MM	33CM	52255-134A1	52255-134A8	52255-134A9	52255-134A10	52255-134A17	52255-134A3	52255-134A4
	5MM	36CM	52236-134A1	52236-134A8	52236-134A9	52236-134A10	52236-134A17	52236-134A3	52236-134A4
	5MM	45CM	52155-134A1	52155-134A8	52155-134A9	52155-134A10	52155-134A17	52155-134A3	52155-134A4
RETRACTION GRASPER, 2 X 3 TEETH, JARIT ST 20I 	5MM	24CM	52224-135A1	52224-135A8	52224-135A9	52224-135A10	52224-135A17	52224-135A3	52224-135A4
	5MM	33CM	52255-135A1	52255-135A8	52255-135A9	52255-135A10	52255-135A17	52255-135A3	52255-135A4
	5MM	36CM	52236-135A1	52236-135A8	52236-135A9	52236-135A10	52236-135A17	52236-135A3	52236-135A4
	5MM	45CM	52155-135A1	52155-135A8	52155-135A9	52155-135A10	52155-135A17	52155-135A3	52155-135A4





5MM DISSECTORS & GRASPERS



MADE IN THE USA



TIP ID & LENGTH	HANDLE		TYPE 1	TYPE 8	TYPE 9	TYPE 10	TYPE 17	TYPE 3	TYPE 4
	DIAMETER	LENGTH							
			INSULATED HANDLES					NON-INSULATED	
CLAW GRASPER, 2 X 3 TEETH, SA 20MM TIP 	5MM	24CM	52224-36A1	52224-36A8	52224-36A9	52224-36A10	52224-36A17	52224-36A3	52224-36A4
	5MM	33CM	52255-36A1	52255-36A8	52255-36A9	52255-36A10	52255-36A17	52255-36A3	52255-36A4
	5MM	36CM	52236-36A1	52236-36A8	52236-36A9	52236-36A10	52236-36A17	52236-36A3	52236-36A4
	5MM	45CM	52155-36A1	52155-36A8	52155-36A9	52155-36A10	52155-36A17	52155-36A3	52155-36A4
CLAW GRASPER, 2 X 3 TEETH, W/ XTRA ROW OF TEETH 20MM TIP 	5MM	24CM	52224-136A1	52224-136A8	52224-136A9	52224-136A10	52224-136A17	52224-136A3	52224-136A4
	5MM	33CM	52255-136A1	52255-136A8	52255-136A9	52255-136A10	52255-136A17	52255-136A3	52255-136A4
	5MM	36CM	52236-136A1	52236-136A8	52236-136A9	52236-136A10	52236-136A17	52236-136A3	52236-136A4
	5MM	45CM	52155-136A1	52155-136A8	52155-136A9	52155-136A10	52155-136A17	52155-136A3	52155-136A4
ATRAUMATIC FENESTRATED GRASPER, CURVED 16MM TIP 	5MM	24CM	52224-37A1	52224-37A8	52224-37A9	52224-37A10	52224-37A17	52224-37A3	52224-37A4
	5MM	33CM	52255-37A1	52255-37A8	52255-37A9	52255-37A10	52255-37A17	52255-37A3	52255-37A4
	5MM	36CM	52236-37A1	52236-37A8	52236-37A9	52236-37A10	52236-37A17	52236-37A3	52236-37A4
	5MM	45CM	52155-37A1	52155-37A8	52155-37A9	52155-37A10	52155-37A17	52155-37A3	52155-37A4
FENESTRATED GRASPER 16MM TIP 	5MM	24CM	52224-38A1	52224-38A8	52224-38A9	52224-38A10	52224-38A17	52224-38A3	52224-38A4
	5MM	33CM	52255-38A1	52255-38A8	52255-38A9	52255-38A10	52255-38A17	52255-38A3	52255-38A4
	5MM	36CM	52236-38A1	52236-38A8	52236-38A9	52236-38A10	52236-38A17	52236-38A3	52236-38A4
	5MM	45CM	52155-38A1	52155-38A8	52155-38A9	52155-38A10	52155-38A17	52155-38A3	52155-38A4
FENESTRATED GRASPER 20MM TIP 	5MM	24CM	52224-39A1	52224-39A8	52224-39A9	52224-39A10	52224-39A17	52224-39A3	52224-39A4
	5MM	33CM	52255-39A1	52255-39A8	52255-39A9	52255-39A10	52255-39A17	52255-39A3	52255-39A4
	5MM	36CM	52236-39A1	52236-39A8	52236-39A9	52236-39A10	52236-39A17	52236-39A3	52236-39A4
	5MM	45CM	52155-39A1	52155-39A8	52155-39A9	52155-39A10	52155-39A17	52155-39A3	52155-39A4
FENESTRATED GRASPER 40MM TIP 	5MM	24CM	52224-40A1	52224-40A8	52224-40A9	52224-40A10	52224-40A17	52224-40A3	52224-40A4
	5MM	33CM	52255-40A1	52255-40A8	52255-40A9	52255-40A10	52255-40A17	52255-40A3	52255-40A4
	5MM	36CM	52236-40A1	52236-40A8	52236-40A9	52236-40A10	52236-40A17	52236-40A3	52236-40A4
	5MM	45CM	52155-40A1	52155-40A8	52155-40A9	52155-40A10	52155-40A17	52155-40A3	52155-40A4
FENESTRATED GRASPER, SA 20MM TIP 	5MM	24CM	52224-41A1	52224-41A8	52224-41A9	52224-41A10	52224-41A17	52224-41A3	52224-41A4
	5MM	33CM	52255-41A1	52255-41A8	52255-41A9	52255-41A10	52255-41A17	52255-41A3	52255-41A4
	5MM	36CM	52236-41A1	52236-41A8	52236-41A9	52236-41A10	52236-41A17	52236-41A3	52236-41A4
	5MM	45CM	52155-41A1	52155-41A8	52155-41A9	52155-41A10	52155-41A17	52155-41A3	52155-41A4





5MM DISSECTORS & GRASPERS



MADE IN THE USA

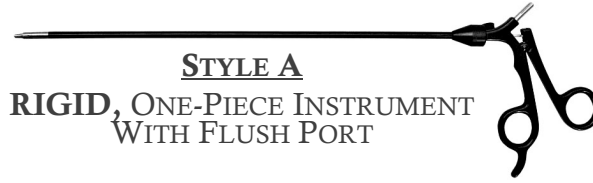

STYLE A
RIGID, ONE-PIECE INSTRUMENT
WITH FLUSH PORT

TIP ID & LENGTH	HANDLE ID		TYPE 1	TYPE 8	TYPE 9	TYPE 10	TYPE 17	TYPE 3	TYPE 4
	DIAMETER	LENGTH							
			INSULATED HANDLES					NON-INSULATED	
JOHAN FENESTRATED GRASPER, SA 45MM TIP 	5MM	24CM	52224-42A1	52224-42A8	52224-42A9	52224-42A10	52224-42A17	52224-42A3	52224-42A4
	5MM	33CM	52255-42A1	52255-42A8	52255-42A9	52255-42A10	52255-42A17	52255-42A3	52255-42A4
	5MM	36CM	52236-42A1	52236-42A8	52236-42A9	52236-42A10	52236-42A17	52236-42A3	52236-42A4
	5MM	45CM	52155-42A1	52155-42A8	52155-42A9	52155-42A10	52155-42A17	52155-42A3	52155-42A4
DOUBLE FENESTRATED GRASPER, 25MM TIP 	5MM	24CM	52224-139A1	52224-139A8	52224-139A9	52224-139A10	52224-139A17	52224-139A3	52224-139A4
	5MM	33CM	52255-139A1	52255-139A8	52255-139A9	52255-139A10	52255-139A17	52255-139A3	52255-139A4
	5MM	36CM	52236-139A1	52236-139A8	52236-139A9	52236-139A10	52236-139A17	52236-139A3	52236-139A4
	5MM	45CM	52155-139A1	52155-139A8	52155-139A9	52155-139A10	52155-139A17	52155-139A3	52155-139A4
KOCHER GRASPER, 1X2 TEETH, SA 15MM TIP 	5MM	24CM	52224-43A1	52224-43A8	52224-43A9	52224-43A10	52224-43A17	52224-43A3	52224-43A4
	5MM	33CM	52255-43A1	52255-43A8	52255-43A9	52255-43A10	52255-43A17	52255-43A3	52255-43A4
	5MM	36CM	52236-43A1	52236-43A8	52236-43A9	52236-43A10	52236-43A17	52236-43A3	52236-43A4
	5MM	45CM	52155-43A1	52155-43A8	52155-43A9	52155-43A10	52155-43A17	52155-43A3	52155-43A4
KOCHER GRASPER, 1X2 TEETH, DA (WECK TYPE) 15MM TIP 	5MM	24CM	52224-44A1	52224-44A8	52224-44A9	52224-44A10	52224-44A17	52224-44A3	52224-44A4
	5MM	33CM	52255-44A1	52255-44A8	52255-44A9	52255-44A10	52255-44A17	52255-44A3	52255-44A4
	5MM	36CM	52236-44A1	52236-44A8	52236-44A9	52236-44A10	52236-44A17	52236-44A3	52236-44A4
	5MM	45CM	52155-44A1	52155-44A8	52155-44A9	52155-44A10	52155-44A17	52155-44A3	52155-44A4
SCHROEDER TENACULUM, SINGLE TOOTH ROUND TIP 25MM TIP 	5MM	24CM	52224-45A1	52224-45A8	52224-45A9	52224-45A10	52224-45A17	52224-45A3	52224-45A4
	5MM	33CM	52255-45A1	52255-45A8	52255-45A9	52255-45A10	52255-45A17	52255-45A3	52255-45A4
	5MM	36CM	52236-45A1	52236-45A8	52236-45A9	52236-45A10	52236-45A17	52236-45A3	52236-45A4
	5MM	45CM	52155-45A1	52155-45A8	52155-45A9	52155-45A10	52155-45A17	52155-45A3	52155-45A4
SCHROEDER TENACULUM, SINGLE TOOTH, SQUARE TIP 25MM TIP 	5MM	24CM	52224-245A1	52224-245A8	52224-245A9	52224-245A10	52224-245A17	52224-245A3	52224-245A4
	5MM	33CM	52255-245A1	52255-245A8	52255-245A9	52255-245A10	52255-245A17	52255-245A3	52255-245A4
	5MM	36CM	52236-245A1	52236-245A8	52236-245A9	52236-245A10	52236-245A17	52236-245A3	52236-245A4
	5MM	45CM	52155-245A1	52155-245A8	52155-245A9	52155-245A10	52155-245A17	52155-245A3	52155-245A4
SCHROEDER TEN. GRASPER, SINGLE TOOTH, XTRA TOOTH 25MM TIP 	5MM	24CM	52224-94A1	52224-94A8	52224-94A9	52224-94A10	52224-94A17	52224-94A3	52224-94A4
	5MM	33CM	52255-94A1	52255-94A8	52255-94A9	52255-94A10	52255-94A17	52255-94A3	52255-94A4
	5MM	36CM	52236-94A1	52236-94A8	52236-94A9	52236-94A10	52236-94A17	52236-94A3	52236-94A4
	5MM	45CM	52155-94A1	52155-94A8	52155-94A9	52155-94A10	52155-94A17	52155-94A3	52155-94A4





5MM DISSECTORS & GRASPERS



MADE IN THE USA

STYLE A
RIGID, ONE-PIECE INSTRUMENT
WITH FLUSH PORT



TIP ID & LENGTH	HANDLE		TYPE 1	TYPE 8	TYPE 9	TYPE 10	TYPE 17	TYPE 3	TYPE 4
	DIAMETER	LENGTH							
			INSULATED HANDLES					NON-INSULATED	
BLUNT ATRAUMATIC GRASPING FORCEPS, DA 14MM TIP 	5MM	24CM	52224-47A1	52224-47A8	52224-47A9	52224-47A10	52224-47A17	52224-47A3	52224-47A4
	5MM	33CM	52255-47A1	52255-47A8	52255-47A9	52255-47A10	52255-47A17	52255-47A3	52255-47A4
	5MM	36CM	52236-47A1	52236-47A8	52236-47A9	52236-47A10	52236-47A17	52236-47A3	52236-47A4
	5MM	45CM	52155-47A1	52155-47A8	52155-47A9	52155-47A10	52155-47A17	52155-47A3	52155-47A4
BLUNT ATRAUMATIC GRASPER W/ CROSS-SERRATED TIPS, DA 14MM TIP 	5MM	24CM	52224-56A1	52224-56A8	52224-56A9	52224-56A10	52224-56A17	52224-56A3	52224-56A4
	5MM	33CM	52255-56A1	52255-56A8	52255-56A9	52255-56A10	52255-56A17	52255-56A3	52255-56A4
	5MM	36CM	52236-56A1	52236-56A8	52236-56A9	52236-56A10	52236-56A17	52236-56A3	52236-56A4
	5MM	45CM	52155-56A1	52155-56A8	52155-56A9	52155-56A10	52155-56A17	52155-56A3	52155-56A4
BULLET NOSE GRASPER TC, MICRO DIAMOND JAW 15MM TIP 	5MM	24CM	52224-48A1	52224-48A8	52224-48A9	52224-48A10	52224-48A17	52224-48A3	52224-48A4
	5MM	33CM	52255-48A1	52255-48A8	52255-48A9	52255-48A10	52255-48A17	52255-48A3	52255-48A4
	5MM	36CM	52236-48A1	52236-48A8	52236-48A9	52236-48A10	52236-48A17	52236-48A3	52236-48A4
	5MM	45CM	52155-48A1	52155-48A8	52155-48A9	52155-48A10	52155-48A17	52155-48A3	52155-48A4
BULLET NOSE GRASPER, TC, CROSS DIAMOND JAW 15MM TIP 	5MM	24CM	52224-49A1	52224-49A8	52224-49A9	52224-49A10	52224-49A17	52224-49A3	52224-49A4
	5MM	33CM	52255-49A1	52255-49A8	52255-49A9	52255-49A10	52255-49A17	52255-49A3	52255-49A4
	5MM	36CM	52236-49A1	52236-49A8	52236-49A9	52236-49A10	52236-49A17	52236-49A3	52236-49A4
	5MM	45CM	52155-49A1	52155-49A8	52155-49A9	52155-49A10	52155-49A17	52155-49A3	52155-49A4
LONG TAPERED GRASPER W/ ATRAUMATIC TEETH 20MM TIP 	5MM	24CM	52224-51A1	52224-51A8	52224-51A9	52224-51A10	52224-51A17	52224-51A3	52224-51A4
	5MM	33CM	52255-51A1	52255-51A8	52255-51A9	52255-51A10	52255-51A17	52255-51A3	52255-51A4
	5MM	36CM	52236-51A1	52236-51A8	52236-51A9	52236-51A10	52236-51A17	52236-51A3	52236-51A4
	5MM	45CM	52155-51A1	52155-51A8	52155-51A9	52155-51A10	52155-51A17	52155-51A3	52155-51A4
WAVE GRASPER, POINTED, SA 14MM TIP 	5MM	24CM	52224-54A1	52224-54A8	52224-54A9	52224-54A10	52224-54A17	52224-54A3	52224-54A4
	5MM	33CM	52255-54A1	52255-54A8	52255-54A9	52255-54A10	52255-54A17	52255-54A3	52255-54A4
	5MM	36CM	52236-54A1	52236-54A8	52236-54A9	52236-54A10	52236-54A17	52236-54A3	52236-54A4
	5MM	45CM	52155-54A1	52155-54A8	52155-54A9	52155-54A10	52155-54A17	52155-54A3	52155-54A4
"ACCESS" TYPE, FENESTRATED GRASPER 20MM TIP 	5MM	24CM	52224-191A1	52224-191A8	52224-191A9	52224-191A10	52224-191A17	52224-191A3	52224-191A4
	5MM	33CM	52255-191A1	52255-191A8	52255-191A9	52255-191A10	52255-191A17	52255-191A3	52255-191A4
	5MM	36CM	52236-191A1	52236-191A8	52236-191A9	52236-191A10	52236-191A17	52236-191A3	52236-191A4
	5MM	45CM	52155-191A1	52155-191A8	52155-191A9	52155-191A10	52155-191A17	52155-191A3	52155-191A4





5MM DISSECTORS & GRASPERS



MADE IN THE USA



STYLE A
RIGID, ONE-PIECE INSTRUMENT
WITH FLUSH PORT

TIP ID & LENGTH	HANDLE ID		TYPE 1	TYPE 8	TYPE 9	TYPE 10	TYPE 17	TYPE 3	TYPE 4
	DIAMETER	LENGTH							
			INSULATED HANDLES					NON-INSULATED	
"SOFT TOUCH" GRASPER, 22MM JAW, TEFLON INSERTS 22MM TIP 	5MM	24CM	52224-144A1	52224-144A8	52224-144A9	52224-144A10	52224-144A17	52224-144A3	52224-144A4
	5MM	33CM	52255-144A1	52255-144A8	52255-144A9	52255-144A10	52255-144A17	52255-144A3	52255-144A4
	5MM	36CM	52236-144A1	52236-144A8	52236-144A9	52236-144A10	52236-144A17	52236-144A3	52236-144A4
	5MM	45CM	52155-144A1	52155-144A8	52155-144A9	52155-144A10	52155-144A17	52155-144A3	52155-144A4
"SOFT TOUCH" GRASPER, 40MM JAW, TEFLON INSERTS 40MM TIP 	5MM	24CM	52224-145A1	52224-145A8	52224-145A9	52224-145A10	52224-145A17	52224-145A3	52224-145A4
	5MM	33CM	52255-145A1	52255-145A8	52255-145A9	52255-145A10	52255-145A17	52255-145A3	52255-145A4
	5MM	36CM	52236-145A1	52236-145A8	52236-145A9	52236-145A10	52236-145A17	52236-145A3	52236-145A4
	5MM	45CM	52155-145A1	52155-145A8	52155-145A9	52155-145A10	52155-145A17	52155-145A3	52155-145A4
TUBAL GRASPER, DA 10MM TIP 	5MM	24CM	52224-156A1	52224-156A8	52224-156A9	52224-156A10	52224-156A17	52224-156A3	52224-156A4
	5MM	33CM	52255-156A1	52255-156A8	52255-156A9	52255-156A10	52255-156A17	52255-156A3	52255-156A4
	5MM	36CM	52236-156A1	52236-156A8	52236-156A9	52236-156A10	52236-156A17	52236-156A3	52236-156A4
	5MM	45CM	52155-156A1	52155-156A8	52155-156A9	52155-156A10	52155-156A17	52155-156A3	52155-156A4
"DAVOL" TYPE SCOOPED- JAW & GENTLY MASH TEETH 15MM TIP 	5MM	24CM	52224-90A1	52224-90A8	52224-90A9	52224-90A10	52224-90A17	52224-90A3	52224-90A4
	5MM	33CM	52255-90A1	52255-90A8	52255-90A9	52255-90A10	52255-90A17	52255-90A3	52255-90A4
	5MM	36CM	52236-90A1	52236-90A8	52236-90A9	52236-90A10	52236-90A17	52236-90A3	52236-90A4
	5MM	45CM	52155-90A1	52155-90A8	52155-90A9	52155-90A10	52155-90A17	52155-90A3	52155-90A4
"DAVOL" TYPE, SCOOPED- JAW & 2 X 3 FRONT TEETH 15MM TIP 	5MM	24CM	52224-190A1	52224-190A8	52224-190A9	52224-190A10	52224-190A17	52224-190A3	52224-190A4
	5MM	33CM	52255-190A1	52255-190A8	52255-190A9	52255-190A10	52255-190A17	52255-190A3	52255-190A4
	5MM	36CM	52236-190A1	52236-190A8	52236-190A9	52236-190A10	52236-190A17	52236-190A3	52236-190A4
	5MM	45CM	52155-190A1	52155-190A8	52155-190A9	52155-190A10	52155-190A17	52155-190A3	52155-190A4
DEBAKEY GRASPER, SA 22MM TIP 	5MM	24CM	52224-122A1	52224-122A8	52224-122A9	52224-122A10	52224-122A17	52224-122A3	52224-122A4
	5MM	33CM	52255-122A1	52255-122A8	52255-122A9	52255-122A10	52255-122A17	52255-122A3	52255-122A4
	5MM	36CM	52236-122A1	52236-122A8	52236-122A9	52236-122A10	52236-122A17	52236-122A3	52236-122A4
	5MM	45CM	52155-122A1	52155-122A8	52155-122A9	52155-122A10	52155-122A17	52155-122A3	52155-122A4





5MM SCISSOR & BIOPSY



MADE IN THE USA



STYLE A
RIGID, ONE-PIECE INSTRUMENT
WITH FLUSH PORT

TIP ID & LENGTH	HANDLE		TYPE 1	TYPE 5	TYPE 9	TYPE 17	TYPE 23	TYPE 3	TYPE 16
	DIAMETER	LENGTH							
			INSULATED HANDLES					NON-INSULATED	
HOOK SCISSORS, SA 10MM TIP 	5MM	24CM	52224-60A1	52224-60A8	52224-60A9	52224-60A17	52224-60A23	52224-60A3	52224-60A16
	5MM	33CM	52255-60A1	52255-60A8	52255-60A9	52255-60A17	52255-60A23	52255-60A3	52255-60A16
	5MM	36CM	52236-60A1	52236-60A8	52236-60A9	52236-60A17	52236-60A23	52236-60A3	52236-60A16
	5MM	45CM	52155-60A1	52155-60A8	52155-60A9	52155-60A17	52155-60A23	52155-60A3	52155-60A16
MICRO TIP SCISSORS, STRAIGHT, SA 5MM TIP 	5MM	24CM	52224-61A1	52224-61A8	52224-61A9	52224-61A17	52224-61A23	52224-61A3	52224-61A16
	5MM	33CM	52255-61A1	52255-61A8	52255-61A9	52255-61A17	52255-61A23	52255-61A3	52255-61A16
	5MM	36CM	52236-61A1	52236-61A8	52236-61A9	52236-61A17	52236-61A23	52236-61A3	52236-61A16
	5MM	45CM	52155-61A1	52155-61A8	52155-61A9	52155-61A17	52155-61A23	52155-61A3	52155-61A16
MICRO TIP SCISSORS, CURVED, SA 5MM TIP 	5MM	24CM	52224-62A1	52224-62A8	52224-62A9	52224-62A17	52224-62A23	52224-62A3	52224-62A16
	5MM	33CM	52255-62A1	52255-62A8	52255-62A9	52255-62A17	52255-62A23	52255-62A3	52255-62A16
	5MM	36CM	52236-62A1	52236-62A8	52236-62A9	52236-62A17	52236-62A23	52236-62A3	52236-62A16
	5MM	45CM	52155-62A1	52155-62A8	52155-62A9	52155-62A17	52155-62A23	52155-62A3	52155-62A16
METZENBAUM SCISSORS, STRAIGHT, LONG BLADE 20MM TIP 	5MM	24CM	52224-63A1	52224-63A8	52224-63A9	52224-63A17	52224-63A23	52224-63A3	52224-63A16
	5MM	33CM	52255-63A1	52255-63A8	52255-63A9	52255-63A17	52255-63A23	52255-63A3	52255-63A16
	5MM	36CM	52236-63A1	52236-63A8	52236-63A9	52236-63A17	52236-63A23	52236-63A3	52236-63A16
	5MM	45CM	52155-63A1	52155-63A8	52155-63A9	52155-63A17	52155-63A23	52155-63A3	52155-63A16
METZENBAUM SCISSORS, STRAIGHT, SHORT BLADE 12MM TIP 	5MM	24CM	52224-64A1	52224-64A8	52224-64A9	52224-64A17	52224-64A23	52224-64A3	52224-64A16
	5MM	33CM	52255-64A1	52255-64A8	52255-64A9	52255-64A17	52255-64A23	52255-64A3	52255-64A16
	5MM	36CM	52236-64A1	52236-64A8	52236-64A9	52236-64A17	52236-64A23	52236-64A3	52236-64A16
	5MM	45CM	52155-64A1	52155-64A8	52155-64A9	52155-64A17	52155-64A23	52155-64A3	52155-64A16
METZENBAUM SCISSORS, CURVED, LONG BLADE 16MM TIP 	5MM	24CM	52224-65A1	52224-65A8	52224-65A9	52224-65A17	52224-65A23	52224-65A3	52224-65A16
	5MM	33CM	52255-65A1	52255-65A8	52255-65A9	52255-65A17	52255-65A23	52255-65A3	52255-65A16
	5MM	36CM	52236-65A1	52236-65A8	52236-65A9	52236-65A17	52236-65A23	52236-65A3	52236-65A16
	5MM	45CM	52155-65A1	52155-65A8	52155-65A9	52155-65A17	52155-65A23	52155-65A3	52155-65A16
METZENBAUM SCISSORS, WONDERCUT, CURVE BLADE 20MM TIP 	5MM	24CM	52224-265A1	52224-265A8	52224-265A9	52224-265A17	52224-265A23	52224-265A3	52224-265A16
	5MM	33CM	52255-265A1	52255-265A8	52255-265A9	52255-265A17	52255-265A23	52255-265A3	52255-265A16
	5MM	36CM	52236-265A1	52236-265A8	52236-265A9	52236-265A17	52236-265A23	52236-265A3	52236-265A16
	5MM	45CM	52155-265A1	52155-265A8	52155-265A9	52155-265A17	52155-265A23	52155-265A3	52155-265A16





5MM SCISSOR & BIOPSY



MADE IN THE USA



TIP ID & LENGTH	HANDLE		TYPE 1	TYPE 5	TYPE 9	TYPE 17	TYPE 23	TYPE 3	TYPE 16
	DIAMETER	LENGTH							
			INSULATED HANDLES					NON-INSULATED	
METZENBAUM SCISSORS, CURVED, SHORT BLADE 12MM TIP 	5MM	24CM	52224-66A1	52224-66A8	52224-66A9	52224-66A17	52224-66A23	52224-66A3	52224-66A16
	5MM	33CM	52255-66A1	52255-66A8	52255-66A9	52255-66A17	52255-66A23	52255-66A3	52255-66A16
	5MM	36CM	52236-66A1	52236-66A8	52236-66A9	52236-66A17	52236-66A23	52236-66A3	52236-66A16
	5MM	45CM	52155-66A1	52155-66A8	52155-66A9	52155-66A17	52155-66A23	52155-66A3	52155-66A16
PERITONEAL SCISSORS, SA 15MM TIP 	5MM	24CM	52224-67A1	52224-67A8	52224-67A9	52224-67A17	52224-67A23	52224-67A3	52224-67A16
	5MM	33CM	52255-67A1	52255-67A8	52255-67A9	52255-67A17	52255-67A23	52255-67A3	52255-67A16
	5MM	36CM	52236-67A1	52236-67A8	52236-67A9	52236-67A17	52236-67A23	52236-67A3	52236-67A16
	5MM	45CM	52155-67A1	52155-67A8	52155-67A9	52155-67A17	52155-67A23	52155-67A3	52155-67A16
BIOPSY SPOON FORCEPS W/ TOOTH 10MM TIP 	5MM	24CM	52224-79A1	52224-79A8	52224-79A9	52224-79A17	52224-79A23	52224-79A3	52224-79A16
	5MM	33CM	52255-79A1	52255-79A8	52255-79A9	52255-79A17	52255-79A23	52255-79A3	52255-79A16
	5MM	36CM	52236-79A1	52236-79A8	52236-79A9	52236-79A17	52236-79A23	52236-79A3	52236-79A16
	5MM	45CM	52155-79A1	52155-79A8	52155-79A9	52155-79A17	52155-79A23	52155-79A3	52155-79A16
BIOPSY SPOON FORCEPS, SHORT, SA 10MM TIP 	5MM	24CM	52224-69A1	52224-69A8	52224-69A9	52224-69A17	52224-69A23	52224-69A3	52224-69A16
	5MM	33CM	52255-69A1	52255-69A8	52255-69A9	52255-69A17	52255-69A23	52255-69A3	52255-69A16
	5MM	36CM	52236-69A1	52236-69A8	52236-69A9	52236-69A17	52236-69A23	52236-69A3	52236-69A16
	5MM	45CM	52155-69A1	52155-69A8	52155-69A9	52155-69A17	52155-69A23	52155-69A3	52155-69A16
POINTED BIOPSY SPOON FORCEPS, SA 10MM TIP 	5MM	24CM	52224-305A1	52224-305A8	52224-305A9	52224-305A17	52224-305A23	52224-305A3	52224-305A16
	5MM	33CM	52255-305A1	52255-305A8	52255-305A9	52255-305A17	52255-305A23	52255-305A3	52255-305A16
	5MM	36CM	52236-305A1	52236-305A8	52236-305A9	52236-305A17	52236-305A23	52236-305A3	52236-305A16
	5MM	45CM	52155-305A1	52155-305A8	52155-305A9	52155-305A17	52155-305A23	52155-305A3	52155-305A16
BIOPSY SPOON FORCEPS, DA 10MM TIP 	5MM	24CM	52224-70A1	52224-70A8	52224-70A9	52224-70A17	52224-70A23	52224-70A3	52224-70A16
	5MM	33CM	52255-70A1	52255-70A8	52255-70A9	52255-70A17	52255-70A23	52255-70A3	52255-70A16
	5MM	36CM	52236-70A1	52236-70A8	52236-70A9	52236-70A17	52236-70A23	52236-70A3	52236-70A16
	5MM	45CM	52155-70A1	52155-70A8	52155-70A9	52155-70A17	52155-70A23	52155-70A3	52155-70A16
BIOPSY SPOON FORCEPS, W/ TOOTH (SEMM-TYPE), D/A 10MM TIP 	5MM	24CM	52224-68A1	52224-68A8	52224-68A9	52224-68A17	52224-68A23	52224-68A3	52224-68A16
	5MM	33CM	52255-68A1	52255-68A8	52255-68A9	52255-68A17	52255-68A23	52255-68A3	52255-68A16
	5MM	36CM	52236-68A1	52236-68A8	52236-68A9	52236-68A17	52236-68A23	52236-68A3	52236-68A16
	5MM	45CM	52155-68A1	52155-68A8	52155-68A9	52155-68A17	52155-68A23	52155-68A3	52155-68A16













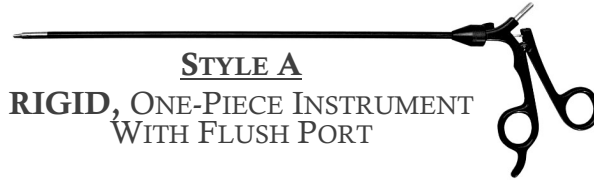

5MM SCISSOR & BIOPSY



MADE IN THE USA

STYLE A
RIGID, ONE-PIECE INSTRUMENT
WITH FLUSH PORT



TIP ID & LENGTH	HANDLE ID		TYPE 1	TYPE 5	TYPE 9	TYPE 17	TYPE 23	TYPE 3	TYPE 16
	DIAMETER	LENGTH							
			INSULATED HANDLES					NON-INSULATED	
BIOPSY PUNCH, SA 10MM TIP 	5MM	24CM	52224-71A1	52224-71A8	52224-71A9	52224-71A17	52224-71A23	52224-71A3	52224-71A16
	5MM	33CM	52255-71A1	52255-71A8	52255-71A9	52255-71A17	52255-71A23	52255-71A3	52255-71A16
	5MM	36CM	52236-71A1	52236-71A8	52236-71A9	52236-71A17	52236-71A23	52236-71A3	52236-71A16
	5MM	45CM	52155-71A1	52155-71A8	52155-71A9	52155-71A17	52155-71A23	52155-71A3	52155-71A16
BIOPSY PUNCH W/ TOOTH, SA 10MM TIP 	5MM	24CM	52224-72A1	52224-72A8	52224-72A9	52224-72A17	52224-72A23	52224-72A3	52224-72A16
	5MM	33CM	52255-72A1	52255-72A8	52255-72A9	52255-72A17	52255-72A23	52255-72A3	52255-72A16
	5MM	36CM	52236-72A1	52236-72A8	52236-72A9	52236-72A17	52236-72A23	52236-72A3	52236-72A16
	5MM	45CM	52155-72A1	52155-72A8	52155-72A9	52155-72A17	52155-72A23	52155-72A3	52155-72A16





10MM DISSECTORS & GRASPERS



MADE IN THE USA



TIP ID & LENGTH	HANDLE ID		TYPE 1	TYPE 8	TYPE 9	TYPE 10	TYPE 17	TYPE 3	TYPE 4
	DIAMETER	LENGTH							
	INSULATED HANDLES							NON-INSULATED	
MARYLAND DISSECTOR 18MM TIP 	10MM	33CM	52102-06A1	52102-06A8	52102-06A9	52102-06A10	52102-06A17	52102-06A3	52102-06A4
	10MM	36CM	52103-06A1	52103-06A8	52103-06A9	52103-06A10	52103-06A17	52103-06A3	52103-06A4
	10MM	45CM	52101-06A1	52101-06A8	52101-06A9	52101-06A10	52101-06A17	52101-06A3	52101-06A4
RIGHT ANGLE MIXTER LONG TEFLON INSERTS 22MM TIP 	10MM	33CM	52102-07B1	52102-07B8	52102-07B9	52102-07B10	52102-07B17	52102-07B3	52102-07B4
	10MM	36CM	52103-07B1	52103-07B8	52103-07B9	52103-07B10	52103-07B17	52103-07B3	52103-07B4
	10MM	45CM	52101-07B1	52101-07B8	52101-07B9	52101-07B10	52101-07B17	52101-07B3	52101-07B4
RIGHT ANGLE MIXTER SHORT 12MM TIP 	10MM	33CM	52102-59A1	52102-59A8	52102-59A9	52102-59A10	52102-59A17	52102-59A3	52102-59A4
	10MM	36CM	52103-59A1	52103-59A8	52103-59A9	52103-59A10	52103-59A17	52103-59A3	52103-59A4
	10MM	45CM	52101-59A1	52101-59A8	52101-59A9	52101-59A10	52101-59A17	52101-59A3	52101-59A4
45° ANGLED MIXTER 20MM TIP 	10MM	33CM	52102-08A1	52102-08A8	52102-08A9	52102-08A10	52102-08A17	52102-08A3	52102-08A4
	10MM	36CM	52103-08A1	52103-08A8	52103-08A9	52103-08A10	52103-08A17	52103-08A3	52103-08A4
	10MM	45CM	52101-08A1	52101-08A8	52101-08A9	52101-08A10	52101-08A17	52101-08A3	52101-08A4
BABCOCK GRASPER FENESTRATED TIP 30MM TIP 	10MM	33CM	52102-16A1	52102-16A8	52102-16A9	52102-16A10	52102-16A17	52102-16A3	52102-16A4
	10MM	36CM	52103-16A1	52103-16A8	52103-16A9	52103-16A10	52103-16A17	52103-16A3	52103-16A4
	10MM	45CM	52101-16A1	52101-16A8	52101-16A9	52101-16A10	52101-16A17	52101-16A3	52101-16A4
ALLIS GRASPER STANDARD VERSION 30MM TIP 	10MM	33CM	52102-21A1	52102-21A8	52102-21A9	52102-21A10	52102-21A17	52102-21A3	52102-21A4
	10MM	36CM	52103-21A1	52103-21A8	52103-21A9	52103-21A10	52103-21A17	52103-21A3	52103-21A4
	10MM	45CM	52101-21A1	52101-21A8	52101-21A9	52101-21A10	52101-21A17	52101-21A3	52101-21A4
DEBAKEY GRASPER 40MM TIP 	10MM	33CM	52102-22A1	52102-22A8	52102-22A9	52102-22A10	52102-22A17	52102-22A3	52102-22A4
	10MM	36CM	52103-22A1	52103-22A8	52103-22A9	52103-22A10	52103-22A17	52103-22A3	52103-22A4
	10MM	45CM	52101-22A1	52101-22A8	52101-22A9	52101-22A10	52101-22A17	52101-22A3	52101-22A4
DEBAKEY GRASPER 60MM TIP 	10MM	33CM	52102-23A1	52102-23A8	52102-23A9	52102-23A10	52102-23A17	52102-23A3	52102-23A4
	10MM	36CM	52103-23A1	52103-23A8	52103-23A9	52103-23A10	52103-23A17	52103-23A3	52103-23A4
	10MM	45CM	52101-23A1	52101-23A8	52101-23A9	52101-23A10	52101-23A17	52101-23A3	52101-23A4
CLAW GRASPER, 2 X 3 TEETH, SA 20MM TIP 	10MM	33CM	52102-36A1	52102-36A8	52102-36A9	52102-36A10	52102-36A17	52102-36A3	52102-36A4
	10MM	36CM	52103-36A1	52103-36A8	52103-36A9	52103-36A10	52103-36A17	52103-36A3	52103-36A4
	10MM	45CM	52101-36A1	52101-36A8	52101-36A9	52101-36A10	52101-36A17	52101-36A3	52101-36A4





10MM DISSECTORS & GRASPERS



MADE IN THE USA



STYLE A
RIGID, ONE-PIECE INSTRUMENT
WITH FLUSH PORT

TIP ID & LENGTH	HANDLE ID		TYPE 1	TYPE 8	TYPE 9	TYPE 10	TYPE 17	TYPE 3	TYPE 4
	DIAMETER	LENGTH							
			INSULATED HANDLES					NON-INSULATED	
SCHROEDER TEN. SINGLE TOOTH 25MM TIP 	10MM	33CM	52102-45A1	52102-45A8	52102-45A9	52102-45A10	52102-45A17	52102-45A3	52102-45A4
	10MM	36CM	52103-45A1	52103-45A8	52103-45A9	52103-45A10	52103-45A17	52103-45A3	52103-45A4
	10MM	45CM	52101-45A1	52101-45A8	52101-45A9	52101-45A10	52101-45A17	52101-45A3	52101-45A4
US BABCOCK SPRING TENSION, ATRAUMATIC 22MM TIP 	10MM	33CM	52102-17A1	52102-17A8	52102-17A9	52102-17A10	52102-17A17	52102-17A3	52102-17A4
	10MM	36CM	52103-17A1	52103-17A8	52103-17A9	52103-17A10	52103-17A17	52103-17A3	52103-17A4
	10MM	45CM	52101-17A1	52101-17A8	52101-17A9	52101-17A10	52101-17A17	52101-17A3	52101-17A4
DUVAL GRASPER, AXIAL SERRATIONS 40MM TIP 	10MM	33CM	52102-26A1	52102-26A8	52102-26A9	52102-26A10	52102-26A17	52102-26A3	52102-26A4
	10MM	36CM	52103-26A1	52103-26A8	52103-26A9	52103-26A10	52103-26A17	52103-26A3	52103-26A4
	10MM	45CM	52101-26A1	52101-26A8	52101-26A9	52101-26A10	52101-26A17	52101-26A3	52101-26A4
STRONG ATRAUMATIC CLAMP, STRAIGHT JAW 40MM TIP 	10MM	33CM	52102-46A1	52102-46A8	52102-46A9	52102-46A10	52102-46A17	52102-46A3	52102-46A4
	10MM	36CM	52103-46A1	52103-46A8	52103-46A9	52103-46A10	52103-46A17	52103-46A3	52103-46A4
	10MM	45CM	52101-46A1	52101-46A8	52101-46A9	52101-46A10	52101-46A17	52101-46A3	52101-46A4
STRONG ATRAUMATIC CLAMP, CURVED JAW 40MM TIP 	10MM	33CM	52102-47A1	52102-47A8	52102-47A9	52102-47A10	52102-47A17	52102-47A3	52102-47A4
	10MM	36CM	52103-47A1	52103-47A8	52103-47A9	52103-47A10	52103-47A17	52103-47A3	52103-47A4
	10MM	45CM	52101-47A1	52101-47A8	52101-47A9	52101-47A10	52101-47A17	52101-47A3	52101-47A4
ANVIL GRASPER TO GRASP & HOLD ANVIL 10MM TIP 	10MM	33CM	52102-20A1	52102-20A8	52102-20A9	52102-20A10	52102-20A17	52102-20A3	52102-20A4
	10MM	36CM	52103-20A1	52103-20A8	52103-20A9	52103-20A10	52103-20A17	52103-20A3	52103-20A4
	10MM	45CM	52101-20A1	52101-20A8	52101-20A9	52101-20A10	52101-20A17	52101-20A3	52101-20A4





10MM DISSECTORS & GRASPERS



MADE IN THE USA

STYLE A
RIGID, ONE-PIECE INSTRUMENT
WITH FLUSH PORT



TIP ID & LENGTH	HANDLE ID		TYPE 1	TYPE 5	TYPE 9	TYPE 17	TYPE 23	TYPE 3	TYPE 16
	DIAMETER	LENGTH							
			INSULATED HANDLES					UNINSULATED HANDLES	
STRAIGHT SCISSORS, SA 20MM TIP 	10MM	33CM	52102-64A1	52102-64A8	52102-64A9	52102-64A10	52102-64A17	52102-64A3	52102-64A4
	10MM	36CM	52103-64A1	52103-64A8	52103-64A9	52103-64A10	52103-64A17	52103-64A3	52103-64A4
	10MM	45CM	52101-64A1	52101-64A8	52101-64A9	52101-64A10	52101-64A17	52101-64A3	52101-64A4
CURVED SCISSORS, DA 20MM TIP 	10MM	33CM	52102-66A1	52102-66A8	52102-66A9	52102-66A10	52102-66A17	52102-66A3	52102-66A4
	10MM	36CM	52103-66A1	52103-66A8	52103-66A9	52103-66A10	52103-66A17	52103-66A3	52103-66A4
	10MM	45CM	52101-66A1	52101-66A8	52101-66A9	52101-66A10	52101-66A17	52101-66A3	52101-66A4
BIOPSY SPOON FORCEPS, SHORT, SA 10MM TIP 	10MM	33CM	52102-37A1	52102-37A8	52102-37A9	52102-37A10	52102-37A17	52102-37A3	52102-37A4
	10MM	36CM	52103-37A1	52103-37A8	52103-37A9	52103-37A10	52103-37A17	52103-37A3	52103-37A4
	10MM	45CM	52101-37A1	52101-37A8	52101-37A9	52101-37A10	52101-37A17	52101-37A3	52101-37A4
BIOPSY SPOON FORCEPS, LONG, SA 25MM TIP 	10MM	33CM	52102-38A1	52102-38A8	52102-38A9	52102-38A10	52102-38A17	52102-38A3	52102-38A4
	10MM	36CM	52103-38A1	52103-38A8	52103-38A9	52103-38A10	52103-38A17	52103-38A3	52103-38A4
	10MM	45CM	52101-38A1	52101-38A8	52101-38A9	52101-38A10	52101-38A17	52101-38A3	52101-38A4





BASIN SERIES

ONE PIECE ROTATABLE LAPAROSCOPIC INSTRUMENTS

THE BASIN SERIES 5MM & 10MM RIGID INSTRUMENTS ARE OUR CLASSIC **ONE-PIECE**, **ROTATABLE** INSTRUMENTS WITH FLUSH PORTS FOR EASY CLEANING. ALL ARE AVAILABLE WITH ANY OF OUR SELECTION OF HANDLES.

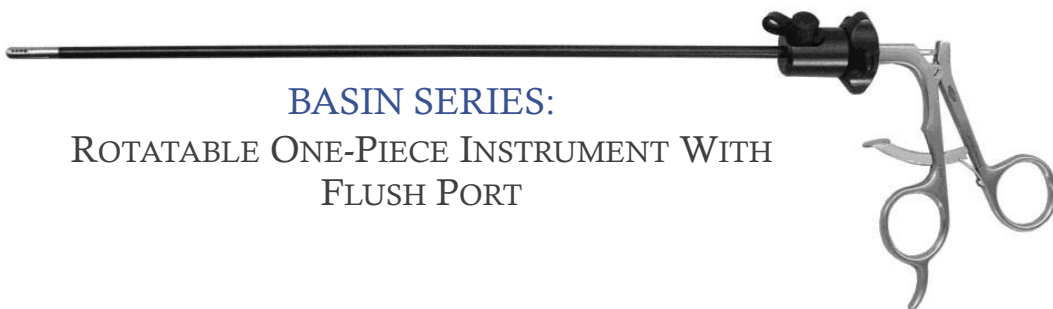

BASIN SERIES:
ROTATABLE ONE-PIECE INSTRUMENT WITH
FLUSH PORT



HANDLES: NON CONDUCTIVE CARBON FIBER



MADE IN THE USA

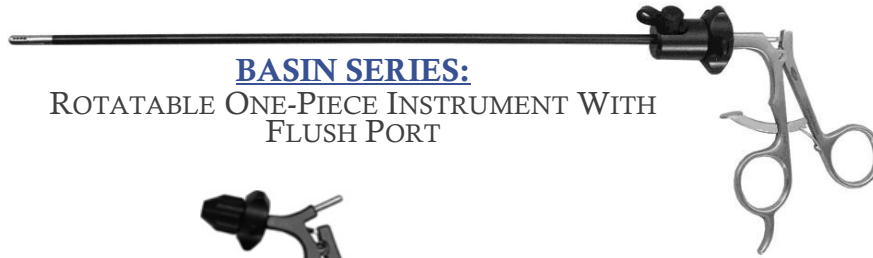

BASIN SERIES:

ROTATABLE ONE-PIECE INSTRUMENT WITH FLUSH PORT

52555-40-01

INSULATED STAINLESS STEEL W/
RF POST
(TYPE 1)



52555-40-02

INSULATED STAINLESS STEEL
W/ RF POST & RATCHET
(TYPE 2)



52555-40-05

INSULATED W/ RF POST &
RATCHET
(TYPE 5)



52555-40-06

LIGHTWEIGHT CARBON FIBER W/
RF POST & ON DEMAND ON/OFF
RATCHET
(TYPE 6)



52555-40-07

LIGHTWEIGHT CARBON-FIBER W/
RF POST, RATCHET / RATCHET
DEFEATING
(TYPE 7)



52555-40-08

LIGHTWEIGHT CARBON-
FIBER W/ RF POST, ON
DEMAND FRENCH, ON/OFF
RATCHET
(TYPE 8)



52555-40-09

LIGHTWEIGHT CARBON-FIBER W/ RF
POST, W/ LARGE FINGER LOOPS
(TYPE 9)



52555-40-10

LIGHTWEIGHT
CARBON-FIBER W/ RF POST,
RATCHET / RATCHET DEFEATING
W/ LARGE FINGER LOOPS
(TYPE 10)



52555-40-14

INSULATED STAINLESS STEEL
LINVATEC-WECK STYLE W/
LONG SHANKS
(TYPE 14)



52555-40-17

LIGHTWEIGHT THERMOS-PLASTIC
W/ RF POST
(TYPE 17)



52555-40-18

LIGHTWEIGHT THERMOS-PLASTIC
W/ RF POST, RATCHET /
RATCHET DEFEATING
(TYPE 18)



52555-40-23

LIGHTWEIGHT THERMO-PLASTIC
W/ RF POST, NON-RATCHET
(TYPE 23)



52555-40-24

LIGHTWEIGHT THERMO-
PLASTIC W/ RF POST, W/
RATCHET
(TYPE 24)





HANDLES: NON-INSULATED



MADE IN THE USA

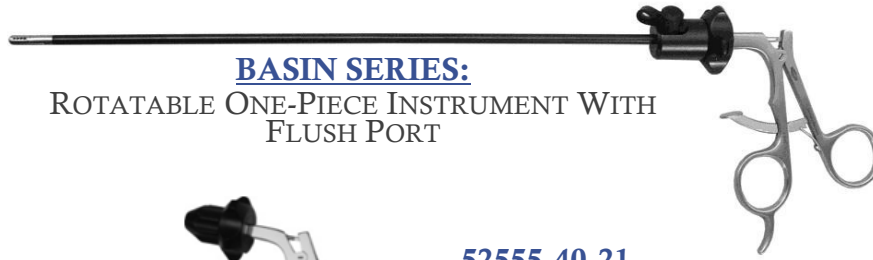

BASIN SERIES:

ROTATABLE ONE-PIECE INSTRUMENT WITH FLUSH PORT

52555-40-03

NON-INSULATED STAINLESS STEEL (TYPE 3)



52555-40-21

STAINLESS STEEL AXIAL HANDLE V-SHAPED W/ SPREADING SPRING & THUMB RELEASE RATCHET (TYPE 21)



52555-40-04

NON-INSULATED STAINLESS STEEL W/ RATCHET (TYPE 4)



52555-40-30

STAINLESS STEEL AXIAL HANDLE V-SHAPED W/ SPREADING SPRING, NON-RATCHET (TYPE 30)



52555-40-11

NON-INSULATED RING AXIAL HANDLE (TYPE 11)

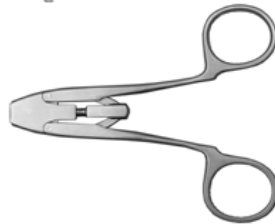

52555-40-19

STAINLESS STEEL AXIAL HANDLE V-SHAPED, ANGLED DOWN W/ SPREADING SPRING & RATCHET (TYPE 19)



52555-40-12

NON-INSULATED RING W/ AXIAL HANDLE W/ RATCHET (TYPE 12)



52555-40-31

STAINLESS STEEL AXIAL HANDLE V-SHAPED, ANGLED DOWN W/ SPREADING SPRING, NON-RATCHET (TYPE 31)



52555-40-13

STAINLESS STEEL AXIAL HANDLE W/ PRECISE ENGAGEMENT RATCHET (TYPE 13)



52555-40-26

ALUMINUM AXIAL HANDLE SINGLE ACTION W/ RATCHET (TYPE 26)



52555-40-15

NON-INSULATED STAINLESS STEEL LINVATEC-WECK STYLE W/ QUICK RELEASE RATCHET & LONG SHANKS (TYPE 15)



52555-40-28

ALUMINUM AXIAL HANDLE SINGLE ACTION, NON-RATCHET (TYPE 28)



52555-40-16

NON-INSULATED STAINLESS STEEL W/ SPRING ASSIST CLOSING (TYPE 16)



52555-40-27

ALUMINUM AXIAL HANDLE, ANGLED DOWN, SINGLE ACTION W/ RATCHET (TYPE 27)



52003-70

SILICONE RUBBER CAP W/ STRAP—10/pkg



52555-40-29

ALUMINUM AXIAL HANDLE, ANGLED DOWN, SINGLE ACTION, NON-RATCHET (TYPE 13)



WE DESIGN, MANUFACTURE & SELL THE TOOLS THE SURGEONS USE



5MM DISSECTORS & GRASPERS



MADE IN THE USA

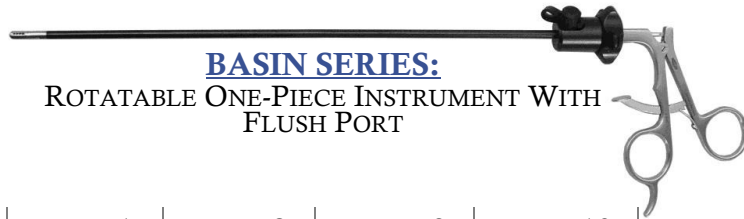

BASIN SERIES:
ROTATABLE ONE-PIECE INSTRUMENT WITH
FLUSH PORT

TIP ID & LENGTH	HANDLE		TYPE 1	TYPE 8	TYPE 9	TYPE 10	TYPE 17	TYPE 3	TYPE 4
	DIAMETER	LENGTH							
			INSULATED HANDLES					NON-INSULATED	
MICRO REDDICK OLSEN 12MM TIP 	5MM	24CM	52224-01B1	52224-01B8	52224-01B9	52224-01B10	52224-01B17	52224-01B3	52224-01B4
	5MM	33CM	52255-01B1	52255-01B8	52255-01B9	52255-01B10	52255-01B17	52255-01B3	52255-01B4
	5MM	36CM	52236-01B1	52236-01B8	52236-01B9	52236-01B10	52236-01B17	52236-01B3	52236-01B4
	5MM	45CM	52155-01B1	52155-01B8	52155-01B9	52155-01B10	52155-01B17	52155-01B3	52155-01B4
STANDARD GRASPER W/ SPOON 12MM TIP 	5MM	24CM	52224-02B1	52224-02B8	52224-02B9	52224-02B10	52224-02B17	52224-02B3	52224-02B4
	5MM	33CM	52255-02B1	52255-02B8	52255-02B9	52255-02B10	52255-02B17	52255-02B3	52255-02B4
	5MM	36CM	52236-02B1	52236-02B8	52236-02B9	52236-02B10	52236-02B17	52236-02B3	52236-02B4
	5MM	45CM	52155-02B1	52155-02B8	52155-02B9	52155-02B10	52155-02B17	52155-02B3	52155-02B4
STANDARD GRASPER W/ SPOON, LONG 20MM TIP 	5MM	24CM	52224-52B1	52224-52B8	52224-52B9	52224-52B10	52224-52B17	52224-52B3	52224-52B4
	5MM	33CM	52255-52B1	52255-52B8	52255-52B9	52255-52B10	52255-52B17	52255-52B3	52255-52B4
	5MM	36CM	52236-52B1	52236-52B8	52236-52B9	52236-52B10	52236-52B17	52236-52B3	52236-52B4
	5MM	45CM	52155-52B1	52155-52B8	52155-52B9	52155-52B10	52155-52B17	52155-52B3	52155-52B4
STANDARD GRASPER 12MM TIP 	5MM	24CM	52224-03B1	52224-03B8	52224-03B9	52224-03B10	52224-03B17	52224-03B3	52224-03B4
	5MM	33CM	52255-03B1	52255-03B8	52255-03B9	52255-03B10	52255-03B17	52255-03B3	52255-03B4
	5MM	36CM	52236-03B1	52236-03B8	52236-03B9	52236-03B10	52236-03B17	52236-03B3	52236-03B4
	5MM	45CM	52155-03B1	52155-03B8	52155-03B9	52155-03B10	52155-03B17	52155-03B3	52155-03B4
BULLET NOSE GRASPER W/ SPOON 12MM TIP 	5MM	24CM	52224-04B1	52224-04B8	52224-04B9	52224-04B10	52224-04B17	52224-04B3	52224-04B4
	5MM	33CM	52255-04B1	52255-04B8	52255-04B9	52255-04B10	52255-04B17	52255-04B3	52255-04B4
	5MM	36CM	52236-04B1	52236-04B8	52236-04B9	52236-04B10	52236-04B17	52236-04B3	52236-04B4
	5MM	45CM	52155-04B1	52155-04B8	52155-04B9	52155-04B10	52155-04B17	52155-04B3	52155-04B4
TAPERED DOLPHIN-NOSE 15MM TIP 	5MM	24CM	52224-05B1	52224-05B8	52224-05B9	52224-05B10	52224-05B17	52224-05B3	52224-05B4
	5MM	33CM	52255-05B1	52255-05B8	52255-05B9	52255-05B10	52255-05B17	52255-05B3	52255-05B4
	5MM	36CM	52236-05B1	52236-05B8	52236-05B9	52236-05B10	52236-05B17	52236-05B3	52236-05B4
	5MM	45CM	52155-05B1	52155-05B8	52155-05B9	52155-05B10	52155-05B17	52155-05B3	52155-05B4
TAPERED DOLPHIN-NOSE W/ SPOON 15MM TIP 	5MM	24CM	52224-105B1	52224-105B8	52224-105B9	52224-105B10	52224-105B17	52224-105B3	52224-105B4
	5MM	33CM	52255-105B1	52255-105B8	52255-105B9	52255-105B10	52255-105B17	52255-105B3	52255-105B4
	5MM	36CM	52236-105B1	52236-105B8	52236-105B9	52236-105B10	52236-105B17	52236-105B3	52236-105B4
	5MM	45CM	52155-105B1	52155-105B8	52155-105B9	52155-105B10	52155-105B17	52155-105B3	52155-105B4





5MM DISSECTORS & GRASPERS



MADE IN THE USA

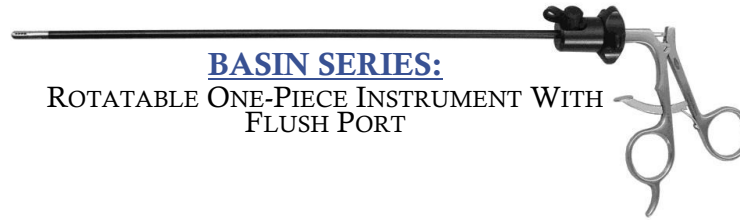

BASIN SERIES:

ROTATABLE ONE-PIECE INSTRUMENT WITH FLUSH PORT

TIP ID & LENGTH	HANDLE		TYPE 1	TYPE 8	TYPE 9	TYPE 10	TYPE 17	TYPE 3	TYPE 4
	DIAMETER	LENGTH							
			INSULATED HANDLES					NON-INSULATED	
TAPERED DOLPHIN-NOSE W/ LONG SPOON 22MM TIP 	5MM	24CM	52224-205B1	52224-205B8	52224-205B9	52224-205B10	52224-205B17	52224-205B3	52224-205B4
	5MM	33CM	52255-205B1	52255-205B8	52255-205B9	52255-205B10	52255-205B17	52255-205B3	52255-205B4
	5MM	36CM	52236-205B1	52236-205B8	52236-205B9	52236-205B10	52236-205B17	52236-205B3	52236-205B4
	5MM	45CM	52155-205B1	52155-205B8	52155-205B9	52155-205B10	52155-205B17	52155-205B3	52155-205B4
MARYLAND DISSECTOR 18MM TIP 	5MM	24CM	52224-06B1	52224-06B8	52224-06B9	52224-06B10	52224-06B17	52224-06B3	52224-06B4
	5MM	33CM	52255-06B1	52255-06B8	52255-06B9	52255-06B10	52255-06B17	52255-06B3	52255-06B4
	5MM	36CM	52236-06B1	52236-06B8	52236-06B9	52236-06B10	52236-06B17	52236-06B3	52236-06B4
	5MM	45CM	52155-06B1	52155-06B8	52155-06B9	52155-06B10	52155-06B17	52155-06B3	52155-06B4
TAPERED MARYLAND DISSECTOR 18MM TIP 	5MM	24CM	52224-106B1	52224-106B8	52224-106B9	52224-106B10	52224-106B17	52224-106B3	52224-106B4
	5MM	33CM	52255-106B1	52255-106B8	52255-106B9	52255-106B10	52255-106B17	52255-106B3	52255-106B4
	5MM	36CM	52236-106B1	52236-106B8	52236-106B9	52236-106B10	52236-106B17	52236-106B3	52236-106B4
	5MM	45CM	52155-106B1	52155-106B8	52155-106B9	52155-106B10	52155-106B17	52155-106B3	52155-106B4
SHORT MARYLAND DISSECTOR 15MM TIP 	5MM	24CM	52224-206B1	52224-206B8	52224-206B9	52224-206B10	52224-206B17	52224-206B3	52224-206B4
	5MM	33CM	52255-206B1	52255-206B8	52255-206B9	52255-206B10	52255-206B17	52255-206B3	52255-206B4
	5MM	36CM	52236-206B1	52236-206B8	52236-206B9	52236-206B10	52236-206B17	52236-206B3	52236-206B4
	5MM	45CM	52155-206B1	52155-206B8	52155-206B9	52155-206B10	52155-206B17	52155-206B3	52155-206B4
RIGHT ANGLE MIXTER LONG 22MM TIP 	5MM	24CM	52224-07B1	52224-07B8	52224-07B9	52224-07B10	52224-07B17	52224-07B3	52224-07B4
	5MM	33CM	52255-07B1	52255-07B8	52255-07B9	52255-07B10	52255-07B17	52255-07B3	52255-07B4
	5MM	36CM	52236-07B1	52236-07B8	52236-07B9	52236-07B10	52236-07B17	52236-07B3	52236-07B4
	5MM	45CM	52155-07B1	52155-07B8	52155-07B9	52155-07B10	52155-07B17	52155-07B3	52155-07B4
RIGHT ANGLE MIXTER, SHORT 12MM TIP 	5MM	24CM	52224-59B1	52224-59B8	52224-59B9	52224-59B10	52224-59B17	52224-59B3	52224-59B4
	5MM	33CM	52255-59B1	52255-59B8	52255-59B9	52255-59B10	52255-59B17	52255-59B3	52255-59B4
	5MM	36CM	52236-59B1	52236-59B8	52236-59B9	52236-59B10	52236-59B17	52236-59B3	52236-59B4
	5MM	45CM	52155-59B1	52155-59B8	52155-59B9	52155-59B10	52155-59B17	52155-59B3	52155-59B4
45° ANGLED MIXTER 20MM TIP 	5MM	24CM	52224-08B1	52224-08B8	52224-08B9	52224-08B10	52224-08B17	52224-08B3	52224-08B4
	5MM	33CM	52255-08B1	52255-08B8	52255-08B9	52255-08B10	52255-08B17	52255-08B3	52255-08B4
	5MM	36CM	52236-08B1	52236-08B8	52236-08B9	52236-08B10	52236-08B17	52236-08B3	52236-08B4
	5MM	45CM	52155-08B1	52155-08B8	52155-08B9	52155-08B10	52155-08B17	52155-08B3	52155-08B4





5MM DISSECTORS & GRASPERS



MADE IN THE USA

BASIN SERIES:
ROTATABLE ONE-PIECE INSTRUMENT WITH
FLUSH PORT

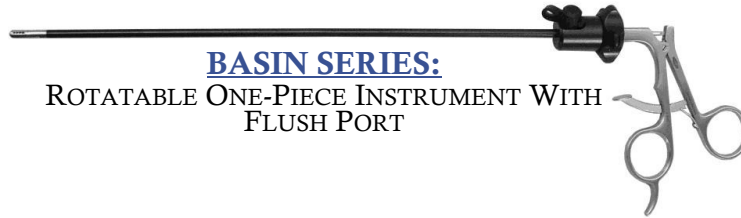

TIP ID & LENGTH	HANDLE		TYPE 1	TYPE 8	TYPE 9	TYPE 10	TYPE 17	TYPE 3	TYPE 4
	DIAMETER	LENGTH							
			INSULATED HANDLES					NON-INSULATED	
DUCKBILL GRASPER 12MM TIP 	5MM	24CM	52224-09B1	52224-09B8	52224-09B9	52224-09B10	52224-09B17	52224-09B3	52224-09B4
	5MM	33CM	52255-09B1	52255-09B8	52255-09B9	52255-09B10	52255-09B17	52255-09B3	52255-09B4
	5MM	36CM	52236-09B1	52236-09B8	52236-09B9	52236-09B10	52236-09B17	52236-09B3	52236-09B4
	5MM	45CM	52155-09B1	52155-09B8	52155-09B9	52155-09B10	52155-09B17	52155-09B3	52155-09B4
NEEDLE-NOSE GRASPER 20MM TIP 	5MM	24CM	52224-10B1	52224-10B8	52224-10B9	52224-10B10	52224-10B17	52224-10B3	52224-10B4
	5MM	33CM	52255-10B1	52255-10B8	52255-10B9	52255-10B10	52255-10B17	52255-10B3	52255-10B4
	5MM	36CM	52236-10B1	52236-10B8	52236-10B9	52236-10B10	52236-10B17	52236-10B3	52236-10B4
	5MM	45CM	52155-10B1	52155-10B8	52155-10B9	52155-10B10	52155-10B17	52155-10B3	52155-10B4
KELLY GRASPER 14MM TIP 	5MM	24CM	52224-11B1	52224-11B8	52224-11B9	52224-11B10	52224-11B17	52224-11B3	52224-11B4
	5MM	33CM	52255-11B1	52255-11B8	52255-11B9	52255-11B10	52255-11B17	52255-11B3	52255-11B4
	5MM	36CM	52236-11B1	52236-11B8	52236-11B9	52236-11B10	52236-11B17	52236-11B3	52236-11B4
	5MM	45CM	52155-11B1	52155-11B8	52155-11B9	52155-11B10	52155-11B17	52155-11B3	52155-11B4
RIGHT ANGLE, LONG REACH GRASPER 22MM TIP 	5MM	24CM	52224-53B1	52224-53B8	52224-53B9	52224-53B10	52224-53B17	52224-53B3	52224-53B4
	5MM	33CM	52255-53B1	52255-53B8	52255-53B9	52255-53B10	52255-53B17	52255-53B3	52255-53B4
	5MM	36CM	52236-53B1	52236-53B8	52236-53B9	52236-53B10	52236-53B17	52236-53B3	52236-53B4
	5MM	45CM	52155-53B1	52155-53B8	52155-53B9	52155-53B10	52155-53B17	52155-53B3	52155-53B4
PETELIN DISSECTOR, 60° ANGLE, SA 10MM TIP 	5MM	24CM	52224-12B1	52224-12B8	52224-12B9	52224-12B10	52224-12B17	52224-12B3	52224-12B4
	5MM	33CM	52255-12B1	52255-12B8	52255-12B9	52255-12B10	52255-12B17	52255-12B3	52255-12B4
	5MM	36CM	52236-12B1	52236-12B8	52236-12B9	52236-12B10	52236-12B17	52236-12B3	52236-12B4
	5MM	45CM	52155-12B1	52155-12B8	52155-12B9	52155-12B10	52155-12B17	52155-12B3	52155-12B4
PETELIN DISSECTOR, 30° ANGLE, SA 10MM TIP 	5MM	24CM	52224-13B1	52224-13B8	52224-13B9	52224-13B10	52224-13B17	52224-13B3	52224-13B4
	5MM	33CM	52255-13B1	52255-13B8	52255-13B9	52255-13B10	52255-13B17	52255-13B3	52255-13B4
	5MM	36CM	52236-13B1	52236-13B8	52236-13B9	52236-13B10	52236-13B17	52236-13B3	52236-13B4
	5MM	45CM	52155-13B1	52155-13B8	52155-13B9	52155-13B10	52155-13B17	52155-13B3	52155-13B4
PETELIN STRONG RIGHT ANGLE DISSECTOR 10MM TIP 	5MM	24CM	52224-113B1	52224-113B8	52224-113B9	52224-113B10	52224-113B17	52224-113B3	52224-113B4
	5MM	33CM	52255-113B1	52255-113B8	52255-113B9	52255-113B10	52255-113B17	52255-113B3	52255-113B4
	5MM	36CM	52236-113B1	52236-113B8	52236-113B9	52236-113B10	52236-113B17	52236-113B3	52236-113B4
	5MM	45CM	52155-113B1	52155-113B8	52155-113B9	52155-113B10	52155-113B17	52155-113B3	52155-113B4





5MM DISSECTORS & GRASPERS



MADE IN THE USA

BASIN SERIES:
ROTATABLE ONE-PIECE INSTRUMENT WITH
FLUSH PORT



TIP ID & LENGTH	HANDLE		TYPE 1	TYPE 8	TYPE 9	TYPE 10	TYPE 17	TYPE 3	TYPE 4
	DIA.	LENGTH							
			INSULATED HANDLES					NON-INSULATED	
MICRO GRASPER FENESTRATED 10MM TIP 	5MM	24CM	52224-14B1	52224-14B8	52224-14B9	52224-14B10	52224-14B17	52224-14I3	52224-14B4
	5MM	33CM	52255-14B1	52255-14B8	52255-14B9	52255-14B10	52255-14B17	52255-14B3	52255-14B4
	5MM	36CM	52236-14B1	52236-14B8	52236-14B9	52236-14B10	52236-14B17	52236-14B3	52236-14B4
	5MM	45CM	52155-14B1	52155-14B8	52155-14B9	52155-14B10	52155-14B17	52155-14B3	52155-14B4
COBRA GRASPER, DA 10MM TIP 	5MM	24CM	52224-15B1	52224-15B8	52224-15B9	52224-15B10	52224-15B17	52224-15B3	52224-15B4
	5MM	33CM	52255-15B1	52255-15B8	52255-15B9	52255-15B10	52255-15B17	52255-15B3	52255-15B4
	5MM	36CM	52236-15B1	52236-15B8	52236-15B9	52236-15B10	52236-15B17	52236-15B3	52236-15B4
	5MM	45CM	52155-15B1	52155-15B8	52155-15B9	52155-15B10	52155-15B17	52155-15B3	52155-15B4
BABCOCK GRASPER, FENESTRATED TIP 30MM TIP 	5MM	24CM	52224-16B1	52224-16B8	52224-16B9	52224-16B10	52224-16B17	52224-16B3	52224-16B4
	5MM	33CM	52255-16B1	52255-16B8	52255-16B9	52255-16B10	52255-16B17	52255-16B3	52255-16B4
	5MM	36CM	52236-16B1	52236-16B8	52236-16B9	52236-16B10	52236-16B17	52236-16B3	52236-16B4
	5MM	45CM	52155-16B1	52155-16B8	52155-16B9	52155-16B10	52155-16B17	52155-16B3	52155-16B4
BABCOCK, AXIS STYLE, FENESTRATED 30MM TIP 	5MM	24CM	52224-116B1	52224-116B8	52224-116B9	52224-116B10	52224-116B17	52224-116B3	52224-116B4
	5MM	33CM	52255-116B1	52255-116B8	52255-116B9	52255-116B10	52255-116B17	52255-116B3	52255-116B4
	5MM	36CM	52236-116B1	52236-116B8	52236-116B9	52236-116B10	52236-116B17	52236-116B3	52236-116B4
	5MM	45CM	52155-116B1	52155-116B8	52155-116B9	52155-116B10	52155-116B17	52155-116B3	52155-116B4
PADDLE BABCOCK GRASPER 30MM TIP 	5MM	24CM	52224-216B1	52224-216B8	52224-216B9	52224-216B10	52224-216B17	52224-216B3	52224-216B4
	5MM	33CM	52255-216B1	52255-216B8	52255-216B9	52255-216B10	52255-216B17	52255-216B3	52255-216B4
	5MM	36CM	52236-216B1	52236-216B8	52236-216B9	52236-216B10	52236-216B17	52236-216B3	52236-216B4
	5MM	45CM	52155-216B1	52155-216B8	52155-216B9	52155-216B10	52155-216B17	52155-216B3	52155-216B4
BABCOCK GRASPER, SHORT DELICATE 20MM TIP 	5MM	24CM	52224-17B1	52224-17B8	52224-17B9	52224-17B10	52224-17B17	52224-17B3	52224-17B4
	5MM	33CM	52255-17B1	52255-17B8	52255-17B9	52255-17B10	52255-17B17	52255-17B3	52255-17B4
	5MM	36CM	52236-17B1	52236-17B8	52236-17B9	52236-17B10	52236-17B17	52236-17B3	52236-17B4
	5MM	45CM	52155-17B1	52155-17B8	52155-17B9	52155-17B10	52155-17B17	52155-17B3	52155-17B4
ALLIS GRASPER, SHORT VERSION, SA 15MM TIP 	5MM	24CM	52224-18B1	52224-18B8	52224-18B9	52224-18B10	52224-18B17	52224-18B3	52224-18B4
	5MM	33CM	52255-18B1	52255-18B8	52255-18B9	52255-18B10	52255-18B17	52255-18B3	52255-18B4
	5MM	36CM	52236-18B1	52236-18B8	52236-18B9	52236-18B10	52236-18B17	52236-18B3	52236-18B4
	5MM	45CM	52155-18B1	52155-18B8	52155-18B9	52155-18B10	52155-18B17	52155-18B3	52155-18B4





5MM DISSECTORS & GRASPERS



MADE IN THE USA

BASIN SERIES:
ROTATABLE ONE-PIECE INSTRUMENT WITH
FLUSH PORT

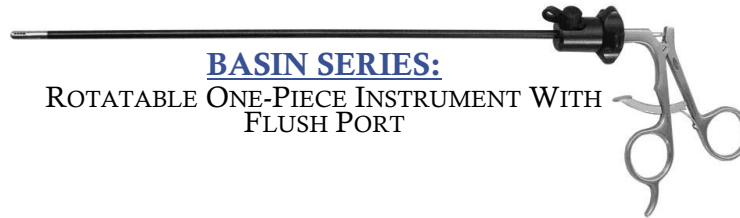

TIP ID & LENGTH	HANDLE		TYPE 1	TYPE 8	TYPE 9	TYPE 10	TYPE 17	TYPE 3	TYPE 4
	DIA.	LENGTH							
			INSULATED HANDLES					NON-INSULATED	
ALLIS, SHORT VERSION, 3 X 4 TEETH, SERRATED 12MM TIP 	5MM	24CM	52224-19B1	52224-19B8	52224-19B9	52224-19B10	52224-19B17	52224-19B3	52224-19B4
	5MM	33CM	52255-19B1	52255-19B8	52255-19B9	52255-19B10	52255-19B17	52255-19B3	52255-19B4
	5MM	36CM	52236-19B1	52236-19B8	52236-19B9	52236-19B10	52236-19B17	52236-19B3	52236-19B4
	5MM	45CM	52155-19B1	52155-19B8	52155-19B9	52155-19B10	52155-19B17	52155-19B3	52155-19B4
ALLIS, SHORT VERSION, DBL. ROW OF TEETH, SERRATED 12MM TIP 	5MM	24CM	52224-119B1	52224-119B8	52224-119B9	52224-119B10	52224-119B17	52224-119B3	52224-119B4
	5MM	33CM	52255-119B1	52255-119B8	52255-119B9	52255-119B10	52255-119B17	52255-119B3	52255-119B4
	5MM	36CM	52236-119B1	52236-119B8	52236-119B9	52236-119B10	52236-119B17	52236-119B3	52236-119B4
	5MM	45CM	52155-119B1	52155-119B8	52155-119B9	52155-119B10	52155-119B17	52155-119B3	52155-119B4
ALLIS, LONG VERSION, DBL ROW OF TEETH, SERRATED 25MM TIP 	5MM	24CM	52224-219B1	52224-219B8	52224-219B9	52224-219B10	52224-219B17	52224-219B3	52224-219B4
	5MM	33CM	52255-219B1	52255-219B8	52255-219B9	52255-219B10	52255-219B17	52255-219B3	52255-219B4
	5MM	36CM	52236-219B1	52236-219B8	52236-219B9	52236-219B10	52236-219B17	52236-219B3	52236-219B4
	5MM	45CM	52155-219B1	52155-219B8	52155-219B9	52155-219B10	52155-219B17	52155-219B3	52155-219B4
ALLIS GRASPER, MEDIUM, WECK STYLE 20MM TIP 	5MM	24CM	52224-20B1	52224-20B8	52224-20B9	52224-20B10	52224-20B17	52224-20B3	52224-20B4
	5MM	33CM	52255-20B1	52255-20B8	52255-20B9	52255-20B10	52255-20B17	52255-20B3	52255-20B4
	5MM	36CM	52236-20B1	52236-20B8	52236-20B9	52236-20B10	52236-20B17	52236-20B3	52236-20B4
	5MM	45CM	52155-20B1	52155-20B8	52155-20B9	52155-20B10	52155-20B17	52155-20B3	52155-20B4
ALLIS GRASPER, STD. VERSION 30MM TIP 	5MM	24CM	52224-21B1	52224-21B8	52224-21B9	52224-21B10	52224-21B17	52224-21B3	52224-21B4
	5MM	33CM	52255-21B1	52255-21B8	52255-21B9	52255-21B10	52255-21B17	52255-21B3	52255-21B4
	5MM	36CM	52236-21B1	52236-21B8	52236-21B9	52236-21B10	52236-21B17	52236-21B3	52236-21B4
	5MM	45CM	52155-21B1	52155-21B8	52155-21B9	52155-21B10	52155-21B17	52155-21B3	52155-21B4
ALLIS GRASPER, TC, STD VERSION 35MM TIP 	5MM	24CM	52224-57B1	52224-57B8	52224-57B9	52224-57B10	52224-57B17	52224-57B3	52224-57B4
	5MM	33CM	52255-57B1	52255-57B8	52255-57B9	52255-57B10	52255-57B17	52255-57B3	52255-57B4
	5MM	36CM	52236-57B1	52236-57B8	52236-57B9	52236-57B10	52236-57B17	52236-57B3	52236-57B4
	5MM	45CM	52155-57B1	52155-57B8	52155-57B9	52155-57B10	52155-57B17	52155-57B3	52155-57B4
DEBAKEY GRASPER 20MM JAW 20MM TIP 	5MM	24CM	52224-22B1	52224-22B8	52224-22B9	52224-22B10	52224-22B17	52224-22B3	52224-22B4
	5MM	33CM	52255-22B1	52255-22B8	52255-22B9	52255-22B10	52255-22B17	52255-22B3	52255-22B4
	5MM	36CM	52236-22B1	52236-22B8	52236-22B9	52236-22B10	52236-22B17	52236-22B3	52236-22B4
	5MM	45CM	52155-22B1	52155-22B8	52155-22B9	52155-22B10	52155-22B17	52155-22B3	52155-22B4





5MM DISSECTORS & GRASPERS



MADE IN THE USA

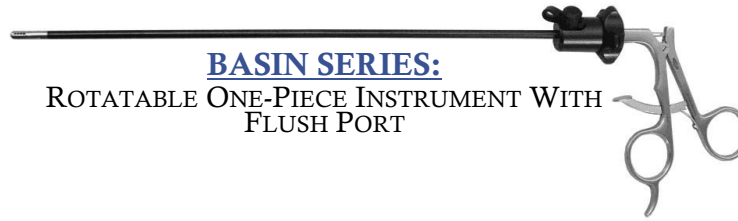

BASIN SERIES:
ROTATABLE ONE-PIECE INSTRUMENT WITH
FLUSH PORT

TIP ID & LENGTH	HANDLE		TYPE 1	TYPE 8	TYPE 9	TYPE 10	TYPE 17	TYPE 3	TYPE 4
	DIAMETER	LENGTH							
	INSULATED HANDLES							UNINSULATED	
DEBAKEY GRASPER 34MM TIP 	5MM	24CM	52224-222B1	52224-222B8	52224-222B9	52224-222B10	52224-222B17	52224-222B3	52224-222B4
	5MM	33CM	52255-222B1	52255-222B8	52255-222B9	52255-222B10	52255-222B17	52255-222B3	52255-222B4
	5MM	36CM	52236-222B1	52236-222B8	52236-222B9	52236-222B10	52236-222B17	52236-222B3	52236-222B4
	5MM	45CM	52155-222B1	52155-222B8	52155-222B9	52155-222B10	52155-222B17	52155-222B3	52155-222B4
DEBAKEY GRASPER 40MM TIP 	5MM	24CM	52224-23B1	52224-23B8	52224-23B9	52224-23B10	52224-23B17	52224-23B3	52224-23B4
	5MM	33CM	52255-23B1	52255-23B8	52255-23B9	52255-23B10	52255-23B17	52255-23B3	52255-23B4
	5MM	36CM	52236-23B1	52236-23B8	52236-23B9	52236-23B10	52236-23B17	52236-23B3	52236-23B4
	5MM	45CM	52155-23B1	52155-23B8	52155-23B9	52155-23B10	52155-23B17	52155-23B3	52155-23A4
DEBAKEY GRASPER 60MM TIP 	5MM	24CM	52224-160B1	52224-160B8	52224-160B9	52224-160B10	52224-160B17	52224-160B3	52224-160B4
	5MM	33CM	52255-160B1	52255-160B8	52255-160B9	52255-160B10	52255-160B17	52255-160B3	52255-160B4
	5MM	36CM	52236-160B1	52236-160B8	52236-160B9	52236-160B10	52236-160B17	52236-160B3	52236-160B4
	5MM	45CM	52155-160B1	52155-160B8	52155-160B9	52155-160B10	52155-160B17	52155-160B3	52155-160B4
HUNTER DEBAKEY, FENESTRATED 16MM TIP 	5MM	24CM	52224-158B1	52224-158B8	52224-158B9	52224-158B10	52224-158B17	52224-158B3	52224-158B4
	5MM	33CM	52255-158B1	52255-158B8	52255-158B9	52255-158B10	52255-158B17	52255-158B3	52255-158B4
	5MM	36CM	52236-158B1	52236-158B8	52236-158B9	52236-158B10	52236-158B17	52236-158B3	52236-158B4
	5MM	45CM	52155-158B1	52155-158B8	52155-158B9	52155-158B10	52155-158B17	52155-158B3	52155-158B4
HUNTER DEBAKEY, FENESTRATED 20MM TIP 	5MM	24CM	52224-58B1	52224-58B8	52224-58B9	52224-58B10	52224-58B17	52224-58B3	52224-58B4
	5MM	33CM	52255-58B1	52255-58B8	52255-58B9	52255-58B10	52255-58B17	52255-58B3	52255-58B4
	5MM	36CM	52236-58B1	52236-58B8	52236-58B9	52236-58B10	52236-58B17	52236-58B3	52236-58B4
	5MM	45CM	52155-58B1	52155-58B8	52155-58B9	52155-58B10	52155-58B17	52155-58B3	52155-58B4
HUNTER DEBAKEY, FENESTRATED 40MM TIP 	5MM	24CM	52224-159B1	52224-159B8	52224-159B9	52224-159B10	52224-159B17	52224-159B3	52224-159B4
	5MM	33CM	52255-159B1	52255-159B8	52255-159B9	52255-159B10	52255-159B17	52255-159B3	52255-159B4
	5MM	36CM	52236-159B1	52236-159B8	52236-159B9	52236-159B10	52236-159B17	52236-159B3	52236-159B4
	5MM	45CM	52155-159B1	52155-159B8	52155-159B9	52155-159B10	52155-159B17	52155-159B3	52155-159B4
HUNTER DEBAKEY, FENESTRATED 60MM TIP 	5MM	24CM	52224-160B1	52224-160B8	52224-160B9	52224-160B10	52224-160B17	52224-160B3	52224-160B4
	5MM	33CM	52255-160B1	52255-160B8	52255-160B9	52255-160B10	52255-160B17	52255-160B3	52255-160B4
	5MM	36CM	52236-160B1	52236-160B8	52236-160B9	52236-160B10	52236-160B17	52236-160B3	52236-160B4
	5MM	45CM	52155-160B1	52155-160B8	52155-160B9	52155-160B10	52155-160B17	52155-160B3	52155-160B4



WE DESIGN, MANUFACTURE & SELL THE TOOLS THE SURGEONS USE



5MM DISSECTORS & GRASPERS



MADE IN THE USA



BASIN SERIES:
ROTATABLE ONE-PIECE INSTRUMENT WITH
FLUSH PORT

TIP ID & LENGTH	HANDLE		TYPE 1	TYPE 8	TYPE 9	TYPE 10	TYPE 17	TYPE 3	TYPE 4
	DIAMETER	LENGTH							
			INSULATED HANDLES					NON-INSULATED	
"WINER" STYLE FUNDUS GRASPER 16MM TIP 	5MM	24CM	52224-326B1	52224-326B8	52224-326B9	52224-326B10	52224-326B17	52224-326B3	52224-326B4
	5MM	33CM	52255-326B1	52255-326B8	52255-326B9	52255-326B10	52255-326B17	52255-326B3	52255-326B4
	5MM	36CM	52236-326B1	52236-326B8	52236-326B9	52236-326B10	52236-326B17	52236-326B3	52236-326B4
	5MM	45CM	52155-326B1	52155-326B8	52155-326B9	52155-326B10	52155-326B17	52155-326B3	52155-326B4
"JARIT STYLE" GRASPING FORCEPS DUAL CUP 16MM TIP 	5MM	24CM	52224-426B1	52224-426B8	52224-426B9	52224-426B10	52224-426B17	52224-426B3	52224-426B4
	5MM	33CM	52255-426B1	52255-426B8	52255-426B9	52255-426B10	52255-426B17	52255-426B3	52255-426B4
	5MM	36CM	52236-426B1	52236-426B8	52236-426B9	52236-426B10	52236-426B17	52236-426B3	52236-426B4
	5MM	45CM	52155-426B1	52155-426B8	52155-426B9	52155-426B10	52155-426B17	52155-426B3	52155-426B4
ENDOCLINCH FENESTRATED GRASPER 20MM TIP 	5MM	24CM	52224-27B1	52224-27B8	52224-27B9	52224-27B10	52224-27B17	52224-27B3	52224-27B4
	5MM	33CM	52255-27B1	52255-27B8	52255-27B9	52255-27B10	52255-27B17	52255-27B3	52255-27B4
	5MM	36CM	52236-27B1	52236-27B8	52236-27B9	52236-27B10	52236-27B17	52236-27B3	52236-27B4
	5MM	45CM	52155-27B1	52155-27B8	52155-27B9	52155-27B10	52155-27B17	52155-27B3	52155-27B4
RETRO-FACING, RAT TOOTH W/ CUP 10MM TIP 	5MM	24CM	52224-28B1	52224-28B8	52224-28B9	52224-28B10	52224-28B17	52224-28B3	52224-28B4
	5MM	33CM	52255-28B1	52255-28B8	52255-28B9	52255-28B10	52255-28B17	52255-28B3	52255-28B4
	5MM	36CM	52236-28B1	52236-28B8	52236-28B9	52236-28B10	52236-28B17	52236-28B3	52236-28B4
	5MM	45CM	52155-28B1	52155-28B8	52155-28B9	52155-28B10	52155-28B17	52155-28B3	52155-28B4
ALLIGATOR GRASPER, RETRO-FACING TEETH, DA 10MM TIP 	5MM	24CM	52224-29B1	52224-29B8	52224-29B9	52224-29B10	52224-29B17	52224-29B3	52224-29B4
	5MM	33CM	52255-29B1	52255-29B8	52255-29B9	52255-29B10	52255-29B17	52255-29B3	52255-29B4
	5MM	36CM	52236-29B1	52236-29B8	52236-29B9	52236-29B10	52236-29B17	52236-29B3	52236-29B4
	5MM	45CM	52155-29B1	52155-29B8	52155-29B9	52155-29B10	52155-29B17	52155-29B3	52155-29B4
ALLIGATOR GRASPER, RETRO-FACING TEETH, DA 20MM TIP 	5MM	24CM	52224-129B1	52224-129B8	52224-129B9	52224-129B10	52224-129B17	52224-129B3	52224-129B4
	5MM	33CM	52255-129B1	52255-129B8	52255-129B9	52255-129B10	52255-129B17	52255-129B3	52255-129B4
	5MM	36CM	52236-129B1	52236-129B8	52236-129B9	52236-129B10	52236-129B17	52236-129B3	52236-129B4
	5MM	45CM	52155-129B1	52155-129B8	52155-129B9	52155-129B10	52155-129B17	52155-129B3	52155-129B4
ALLIGATOR GRASPER, RETRO-FACING TEETH, SA 10MM TIP 	5MM	24CM	52224-30B1	52224-30B8	52224-30B9	52224-30B10	52224-30B17	52224-30B3	52224-30B4
	5MM	33CM	52255-30B1	52255-30B8	52255-30B9	52255-30B10	52255-30B17	52255-30B3	52255-30B4
	5MM	36CM	52236-30B1	52236-30B8	52236-30B9	52236-30B10	52236-30B17	52236-30B3	52236-30B4
	5MM	45CM	52155-30B1	52155-30B8	52155-30B9	52155-30B10	52155-30B17	52155-30B3	52155-30B4





5MM DISSECTORS & GRASPERS



MADE IN THE USA

BASIN SERIES:
ROTATABLE ONE-PIECE INSTRUMENT WITH
FLUSH PORT



TIP ID & LENGTH	HANDLE		TYPE 1	TYPE 8	TYPE 9	TYPE 10	TYPE 17	TYPE 3	TYPE 4
	DIAMETER	LENGTH							
			INSULATED					NON-INSULATED	
CUP SHAPED GRASPER, W/ RETRO-FACING TEETH 10MM TIP 	5MM	24CM	52224-31B1	52224-31B8	52224-31B9	52224-31B10	52224-31B17	52224-31B3	52224-31B4
	5MM	33CM	52255-31B1	52255-31B8	52255-31B9	52255-31B10	52255-31B17	52255-31B3	52255-31B4
	5MM	36CM	52236-31B1	52236-31B8	52236-31B9	52236-31B10	52236-31B17	52236-31B3	52236-31B4
	5MM	45CM	52155-31B1	52155-31B8	52155-31B9	52155-31B10	52155-31B17	52155-31B3	52155-31B4
WAVE GRASPER, LONG BEVELED EDGE, DA 22MM TIP 	5MM	24CM	52224-32B1	52224-32B8	52224-32B9	52224-32B10	52224-32B17	52224-32B3	52224-32B4
	5MM	33CM	52255-32B1	52255-32B8	52255-32B9	52255-32B10	52255-32B17	52255-32B3	52255-32B4
	5MM	36CM	52236-32B1	52236-32B8	52236-32B9	52236-32B10	52236-32B17	52236-32B3	52236-32B4
	5MM	45CM	52155-32B1	52155-32B8	52155-32B9	52155-32B10	52155-32B17	52155-32B3	52155-32B4
WAVE GRASPER, LONG BEVELED EDGE, SA 22MM TIP 	5MM	24CM	52224-33B1	52224-33B8	52224-33B9	52224-33B10	52224-33B17	52224-33B3	52224-33B4
	5MM	33CM	52255-33B1	52255-33B8	52255-33B9	52255-33B10	52255-33B17	52255-33B3	52255-33B4
	5MM	36CM	52236-33B1	52236-33B8	52236-33B9	52236-33B10	52236-33B17	52236-33B3	52236-33B4
	5MM	45CM	52155-33B1	52155-33B8	52155-33B9	52155-33B10	52155-33B17	52155-33B3	52155-33B4
RETRACTION GRASPER, 2 X 3 TEETH, COBRA STYLE, DA 20MM TIP 	5MM	24CM	52224-34B1	52224-34B8	52224-34B9	52224-34B10	52224-34B17	52224-34B3	52224-34B4
	5MM	33CM	52255-34B1	52255-34B8	52255-34B9	52255-34B10	52255-34B17	52255-34B3	52255-34B4
	5MM	36CM	52236-34B1	52236-34B8	52236-34B9	52236-34B10	52236-34B17	52236-34B3	52236-34B4
	5MM	45CM	52155-34B1	52155-34B8	52155-34B9	52155-34B10	52155-34B17	52155-34B3	52155-34B4
RETRACTION GRASPER, 2 X 3 TEETH, COBRA STYLE, SA 20MM TIP 	5MM	24CM	52224-35B1	52224-35B8	52224-35B9	52224-35B10	52224-35B17	52224-35B3	52224-35B4
	5MM	33CM	52255-35B1	52255-35B8	52255-35B9	52255-35B10	52255-35B17	52255-35B3	52255-35B4
	5MM	36CM	52236-35B1	52236-35B8	52236-35B9	52236-35B10	52236-35B17	52236-35B3	52236-35B4
	5MM	45CM	52155-35B1	52155-35B8	52155-35B9	52155-35B10	52155-35B17	52155-35B3	52155-35B4
RETRACTION GRASPER, 2 X 3 TEETH, JARIT STYLE, DA 20MM TIP 	5MM	24CM	52224-134B1	52224-134B8	52224-134B9	52224-134B10	52224-134B17	52224-134B3	52224-134B4
	5MM	33CM	52255-134B1	52255-134B8	52255-134B9	52255-134B10	52255-134B17	52255-134B3	52255-134B4
	5MM	36CM	52236-134B1	52236-134B8	52236-134B9	52236-134B10	52236-134B17	52236-134B3	52236-134B4
	5MM	45CM	52155-134B1	52155-134B8	52155-134B9	52155-134B10	52155-134B17	52155-134B3	52155-134B4
RETRACTION GRASPER, 2 X 3 TEETH, JARIT STYLE, SA 20MM TIP 	5MM	24CM	52224-135B1	52224-135B8	52224-135B9	52224-135B10	52224-135B17	52224-135B3	52224-135B4
	5MM	33CM	52255-135B1	52255-135B8	52255-135B9	52255-135B10	52255-135B17	52255-135B3	52255-135B4
	5MM	36CM	52236-135B1	52236-135B8	52236-135B9	52236-135B10	52236-135B17	52236-135B3	52236-135B4
	5MM	45CM	52155-135B1	52155-135B8	52155-135B9	52155-135B10	52155-135B17	52155-135B3	52155-135B4





5MM DISSECTORS & GRASPERS



MADE IN THE USA

BASIN SERIES:
ROTATABLE ONE-PIECE INSTRUMENT WITH
FLUSH PORT



TIP ID & LENGTH	HANDLE		TYPE 1	TYPE 8	TYPE 9	TYPE 10	TYPE 17	TYPE 3	TYPE 4
	DIAMETER	LENGTH							
			INSULATED HANDLES				NON-INSULATED		
CLAW GRASPER, 2 X 3 TEETH, SA 20MM TIP 	5MM	24CM	52224-36B1	52224-36B8	52224-36B9	52224-36B10	52224-36B17	52224-36B3	52224-36B4
	5MM	33CM	52255-36B1	52255-36B8	52255-36B9	52255-36B10	52255-36B17	52255-36B3	52255-36B4
	5MM	36CM	52236-36B1	52236-36B8	52236-36B9	52236-36B10	52236-36B17	52236-36B3	52236-36B4
	5MM	45CM	52155-36B1	52155-36B8	52155-36B9	52155-36B10	52155-36B17	52155-36B3	52155-36B4
CLAW GRASPER, 2 X 3 TEETH, W/ XTRA ROW OF TEETH 20MM TIP 	5MM	24CM	52224-136B1	52224-136B8	52224-136B9	52224-136B10	52224-136B17	52224-136B3	52224-136B4
	5MM	33CM	52255-136B1	52255-136B8	52255-136B9	52255-136B10	52255-136B17	52255-136B3	52255-136B4
	5MM	36CM	52236-136B1	52236-136B8	52236-136B9	52236-136B10	52236-136B17	52236-136B3	52236-136B4
	5MM	45CM	52155-136B1	52155-136B8	52155-136B9	52155-136B10	52155-136B17	52155-136B3	52155-136B4
ATRAUMATIC FENESTRATED GRASPER, CURVED 16MM TIP 	5MM	24CM	52224-37B1	52224-37B8	52224-37B9	52224-37B10	52224-37B17	52224-37B3	52224-37B4
	5MM	33CM	52255-37B1	52255-37B8	52255-37B9	52255-37B10	52255-37B17	52255-37B3	52255-37B4
	5MM	36CM	52236-37B1	52236-37B8	52236-37B9	52236-37B10	52236-37B17	52236-37B3	52236-37B4
	5MM	45CM	52155-37B1	52155-37B8	52155-37B9	52155-37B10	52155-37B17	52155-37B3	52155-37B4
FENESTRATED GRASPER, 16MM JAW 16MM TIP 	5MM	24CM	52224-38B1	52224-38B8	52224-38B9	52224-38B10	52224-38B17	52224-38B3	52224-38B4
	5MM	33CM	52255-38B1	52255-38B8	52255-38B9	52255-38B10	52255-38B17	52255-38B3	52255-38B4
	5MM	36CM	52236-38B1	52236-38B8	52236-38B9	52236-38B10	52236-38B17	52236-38B3	52236-38B4
	5MM	45CM	52155-38B1	52155-38B8	52155-38B9	52155-38B10	52155-38B17	52155-38B3	52155-38B4
FENESTRATED GRASPER, 20MM JAW 20MM TIP 	5MM	24CM	52224-39B1	52224-39B8	52224-39B9	52224-39B10	52224-39B17	52224-39B3	52224-39B4
	5MM	33CM	52255-39B1	52255-39B8	52255-39B9	52255-39B10	52255-39B17	52255-39B3	52255-39B4
	5MM	36CM	52236-39B1	52236-39B8	52236-39B9	52236-39B10	52236-39B17	52236-39B3	52236-39B4
	5MM	45CM	52155-39B1	52155-39B8	52155-39B9	52155-39B10	52155-39B17	52155-39B3	52155-39B4
FENESTRATED GRASPER 40MM JAW 40MM TIP 	5MM	24CM	52224-40B1	52224-40B8	52224-40B9	52224-40B10	52224-40B17	52224-40B3	52224-40B4
	5MM	33CM	52255-40B1	52255-40B8	52255-40B9	52255-40B10	52255-40B17	52255-40B3	52255-40B4
	5MM	36CM	52236-40B1	52236-40B8	52236-40B9	52236-40B10	52236-40B17	52236-40B3	52236-40B4
	5MM	45CM	52155-40B1	52155-40B8	52155-40B9	52155-40B10	52155-40B17	52155-40B3	52155-40B4
JOHAN FENESTRATED GRASPER 20MM TIP, SA 20MM TIP 	5MM	24CM	52224-41B1	52224-41B8	52224-41B9	52224-41B10	52224-41B17	52224-41B3	52224-41B4
	5MM	33CM	52255-41B1	52255-41B8	52255-41B9	52255-41B10	52255-41B17	52255-41B3	52255-41B4
	5MM	36CM	52236-41B1	52236-41B8	52236-41B9	52236-41B10	52236-41B17	52236-41B3	52236-41B4
	5MM	45CM	52155-41B1	52155-41B8	52155-41B9	52155-41B10	52155-41B17	52155-41B3	52155-41B4





5MM DISSECTORS & GRASPERS



MADE IN THE USA

BASIN SERIES:
ROTATABLE ONE-PIECE INSTRUMENT WITH
FLUSH PORT



TIP ID & LENGTH	HANDLE		TYPE 1	TYPE 8	TYPE 9	TYPE 10	TYPE 17	TYPE 3	TYPE 4
	DIA.	LENGTH							
			INSULATED HANDLES					NON-INSULATED	
JOHNSAN FENESTRATED GRASPER, SA 45MM TIP 	5MM	24CM	52224-42B1	52224-42B8	52224-42B9	52224-42B10	52224-42B17	52224-42B3	52224-42B4
	5MM	33CM	52255-42B1	52255-42B8	52255-42B9	52255-42B10	52255-42B17	52255-42B3	52255-42B4
	5MM	36CM	52236-42B1	52236-42B8	52236-42B9	52236-42B10	52236-42B17	52236-42B3	52236-42B4
	5MM	45CM	52155-42B1	52155-42B8	52155-42B9	52155-42B10	52155-42B17	52155-42B3	52155-42B4
DOUBLE FENESTRATED GRASPER 25MM TIP 	5MM	24CM	52224-139B1	52224-139B8	52224-139B9	52224-139B10	52224-139B17	52224-139B3	52224-139B4
	5MM	33CM	52255-139B1	52255-139B8	52255-139B9	52255-139B10	52255-139B17	52255-139B3	52255-139B4
	5MM	36CM	52236-139B1	52236-139B8	52236-139B9	52236-139B10	52236-139B17	52236-139B3	52236-139B4
	5MM	45CM	52155-139B1	52155-139B8	52155-139B9	52155-139B10	52155-139B17	52155-139B3	52155-139B4
KOCHER GRASPER, 1 X 2 TEETH, SA 15MM TIP 	5MM	24CM	52224-43B1	52224-43B8	52224-43B9	52224-43B10	52224-43B17	52224-43B3	52224-43B4
	5MM	33CM	52255-43B1	52255-43B8	52255-43B9	52255-43B10	52255-43B17	52255-43B3	52255-43B4
	5MM	36CM	52236-43B1	52236-43B8	52236-43B9	52236-43B10	52236-43B17	52236-43B3	52236-43B4
	5MM	45CM	52155-43B1	52155-43B8	52155-43B9	52155-43B10	52155-43B17	52155-43B3	52155-43B4
KOCHER GRASPER, 1 X 2 TEETH, DA (WECK TYPE) 15MM TIP 	5MM	24CM	52224-44B1	52224-44B8	52224-44B9	52224-44B10	52224-44B17	52224-44B3	52224-44B4
	5MM	33CM	52255-44B1	52255-44B8	52255-44B9	52255-44B10	52255-44B17	52255-44B3	52255-44B4
	5MM	36CM	52236-44B1	52236-44B8	52236-44B9	52236-44B10	52236-44B17	52236-44B3	52236-44B4
	5MM	45CM	52155-44B1	52155-44B8	52155-44B9	52155-44B10	52155-44B17	52155-44B3	52155-44B4
SCHROEDER TENACULUM, SINGLE TOOTH, ROUND TIP 25MM TIP 	5MM	24CM	52224-45B1	52224-45B8	52224-45B9	52224-45B10	52224-45B17	52224-45B3	52224-45B4
	5MM	33CM	52255-45B1	52255-45B8	52255-45B9	52255-45B10	52255-45B17	52255-45B3	52255-45B4
	5MM	36CM	52236-45B1	52236-45B8	52236-45B9	52236-45B10	52236-45B17	52236-45B3	52236-45B4
	5MM	45CM	52155-45B1	52155-45B8	52155-45B9	52155-45B10	52155-45B17	52155-45B3	52155-45B4
SCHROEDER TENACULUM, SINGLE TOOTH, SQUARE TIP 25MM TIP 	5MM	24CM	52224-245B1	52224-245B8	52224-245B9	52224-245B10	52224-245B17	52224-245B3	52224-245B4
	5MM	33CM	52255-245B1	52255-245B8	52255-245B9	52255-245B10	52255-245B17	52255-245B3	52255-245B4
	5MM	36CM	52236-245B1	52236-245B8	52236-245B9	52236-245B10	52236-245B17	52236-245B3	52236-245B4
	5MM	45CM	52155-245B1	52155-245B8	52155-245B9	52155-245B10	52155-245B17	52155-245B3	52155-245B4
SCHROEDER TEN. GRASPER, SINGLE TOOTH, XTRA TOOTH 25MM TIP 	5MM	24CM	52224-94B1	52224-94B8	52224-94B9	52224-94B10	52224-94B17	52224-94B3	52224-94B4
	5MM	33CM	52255-94B1	52255-94B8	52255-94B9	52255-94B10	52255-94B17	52255-94B3	52255-94B4
	5MM	36CM	52236-94B1	52236-94B8	52236-94B9	52236-94B10	52236-94B17	52236-94B3	52236-94B4
	5MM	45CM	52155-94B1	52155-94B8	52155-94B9	52155-94B10	52155-94B17	52155-94B3	52155-94B4











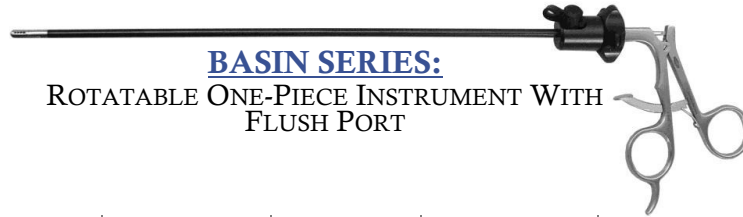







5MM DISSECTORS & GRASPERS

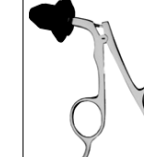
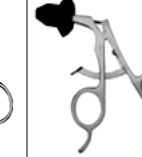

MADE IN THE USA



BASIN SERIES:
ROTATABLE ONE-PIECE INSTRUMENT WITH
FLUSH PORT

TIP ID & LENGTH	HANDLE		TYPE 1	TYPE 8	TYPE 9	TYPE 10	TYPE 17	TYPE 3	TYPE 4
	DIA.	LENGTH							
			INSULATED HANDLES					NON-INSULATED	
DEBAKEY GRASPER, CURVED 30MM TIP 	5MM	24CM	52224-46B1	52224-46B8	52224-46B9	52224-46B10	52224-46B17	52224-46B3	52224-46B4
	5MM	33CM	52255-46B1	52255-46B8	52255-46B9	52255-46B10	52255-46B17	52255-46B3	52255-46B4
	5MM	36CM	52236-46B1	52236-46B8	52236-46B9	52236-46B10	52236-46B17	52236-46B3	52236-46B4
	5MM	45CM	52155-46B1	52155-46B8	52155-46B9	52155-46B10	52155-46B17	52155-46B3	52155-46B4
DEBAKEY MARYLAND GRASPER 35MM TIP 	5MM	24CM	52224-149B1	52224-149B8	52224-149B9	52224-149B10	52224-149B17	52224-149B3	52224-149B4
	5MM	33CM	52255-149B1	52255-149B8	52255-149B9	52255-149B10	52255-149B17	52255-149B3	52255-149B4
	5MM	36CM	52236-149B1	52236-149B8	52236-149B9	52236-149B10	52236-149B17	52236-149B3	52236-149B4
	5MM	45CM	52155-149B1	52155-149B8	52155-149B9	52155-149B10	52155-149B17	52155-149B3	52155-149B4
GLASSMAN ATRAUMATIC GRASPER 30MM TIP 	5MM	24CM	52224-24B1	52224-24B8	52224-24B9	52224-24B10	52224-24B17	52224-24B3	52224-24B4
	5MM	33CM	52255-24B1	52255-24B8	52255-24B9	52255-24B10	52255-24B17	52255-24B3	52255-24B4
	5MM	36CM	52236-24B1	52236-24B8	52236-24B9	52236-24B10	52236-24B17	52236-24B3	52236-24B4
	5MM	45CM	52155-24B1	52155-24B8	52155-24B9	52155-24B10	52155-24B17	52155-24B3	52155-24B4
GRASPER, CROSS SERRATED, SA 10MM TIP 	5MM	24CM	52224-25B1	52224-25B8	52224-25B9	52224-25B10	52224-25B17	52224-25B3	52224-25B4
	5MM	33CM	52255-25B1	52255-25B8	52255-25B9	52255-25B10	52255-25B17	52255-25B3	52255-25B4
	5MM	36CM	52236-25B1	52236-25B8	52236-25B9	52236-25B10	52236-25B17	52236-25B3	52236-25B4
	5MM	45CM	52155-25B1	52155-25B8	52155-25B9	52155-25B10	52155-25B17	52155-25B3	52155-25B4
DOUBLE CUP FUNDUS MAXI GRASPER 16MM TIP 	5MM	24CM	52224-26B1	52224-26B8	52224-26B9	52224-26B10	52224-26B17	52224-26B3	52224-26B4
	5MM	33CM	52255-26B1	52255-26B8	52255-26B9	52255-26B10	52255-26B17	52255-26B3	52255-26B4
	5MM	36CM	52236-26B1	52236-26B8	52236-26B9	52236-26B10	52236-26B17	52236-26B3	52236-26B4
	5MM	45CM	52155-26B1	52155-26B8	52155-26B9	52155-26B10	52155-26B17	52155-26B3	52155-26B4
FENESTRATED DBL. FUNDUS GRASPER 16MM TIP 	5MM	24CM	52224-226B1	52224-226B8	52224-226B9	52224-226B10	52224-226B17	52224-226B3	52224-226B4
	5MM	33CM	52255-226B1	52255-226B8	52255-226B9	52255-226B10	52255-226B17	52255-226B3	52255-226B4
	5MM	36CM	52236-226B1	52236-226B8	52236-226B9	52236-226B10	52236-226B17	52236-226B3	52236-226B4
	5MM	45CM	52155-226B1	52155-226B8	52155-226B9	52155-226B10	52155-226B17	52155-226B3	52155-226B4
"MCKEARNAN" STYLE FUNDUS GRASPER 16MM TIP 	5MM	24CM	52224-126B1	52224-126B8	52224-126B9	52224-126B10	52224-126B17	52224-126B3	52224-126B4
	5MM	33CM	52255-126B1	52255-126B8	52255-126B9	52255-126B10	52255-126B17	52255-126B3	52255-126B4
	5MM	36CM	52236-126B1	52236-126B8	52236-126B9	52236-126B10	52236-126B17	52236-126B3	52236-126B4
	5MM	45CM	52155-126B1	52155-126B8	52155-126B9	52155-126B10	52155-126B17	52155-126B3	52155-126B4





5MM DISSECTORS & GRASPERS



MADE IN THE USA

BASIN SERIES:
ROTATABLE ONE-PIECE INSTRUMENT WITH
FLUSH PORT



TIP ID & LENGTH	HANDLE		TYPE 1	TYPE 8	TYPE 9	TYPE 10	TYPE 17	TYPE 3	TYPE 4
	DIAMETER	LENGTH							
			INSULATED HANDLES					NON-INSULATED	
BLUNT ATRAUMATIC GRASPING FORCEPS, DA 14MM TIP 	5MM	24CM	52224-47B1	52224-47B8	52224-47B9	52224-47B10	52224-47B17	52224-47B3	52224-47B4
	5MM	33CM	52255-47B1	52255-47B8	52255-47B9	52255-47B10	52255-47B17	52255-47B3	52255-47B4
	5MM	36CM	52236-47B1	52236-47B8	52236-47B9	52236-47B10	52236-47B17	52236-47B3	52236-47B4
	5MM	45CM	52155-47B1	52155-47B8	52155-47B9	52155-47B10	52155-47B17	52155-47B3	52155-47B4
BLUNT ATRAUMATIC GRASPER W/ CROSS-SERRATED TIPS, DA 14MM TIP 	5MM	24CM	52224-56B1	52224-56B8	52224-56B9	52224-56B10	52224-56B17	52224-56B3	52224-56B4
	5MM	33CM	52255-56B1	52255-56B8	52255-56B9	52255-56B10	52255-56B17	52255-56B3	52255-56B4
	5MM	36CM	52236-56B1	52236-56B8	52236-56B9	52236-56B10	52236-56B17	52236-56B3	52236-56B4
	5MM	45CM	52155-56B1	52155-56B8	52155-56B9	52155-56B10	52155-56B17	52155-56B3	52155-56B4
BULLET NOSE GRASPER TC, MICRO DIAMOND JAW 15MM TIP 	5MM	24CM	52224-48B1	52224-48B8	52224-48B9	52224-48B10	52224-48B17	52224-48B3	52224-48B4
	5MM	33CM	52255-48B1	52255-48B8	52255-48B9	52255-48B10	52255-48B17	52255-48B3	52255-48B4
	5MM	36CM	52236-48B1	52236-48B8	52236-48B9	52236-48B10	52236-48B17	52236-48B3	52236-48B4
	5MM	45CM	52155-48B1	52155-48B8	52155-48B9	52155-48B10	52155-48B17	52155-48B3	52155-48B4
BULLET NOSE GRASPER, TC, CROSS DIAMOND JAW 15MM TIP 	5MM	24CM	52224-49B1	52224-49B8	52224-49B9	52224-49B10	52224-49B17	52224-49B3	52224-49B4
	5MM	33CM	52255-49B1	52255-49B8	52255-49B9	52255-49B10	52255-49B17	52255-49B3	52255-49B4
	5MM	36CM	52236-49B1	52236-49B8	52236-49B9	52236-49B10	52236-49B17	52236-49B3	52236-49B4
	5MM	45CM	52155-49B1	52155-49B8	52155-49B9	52155-49B10	52155-49B17	52155-49B3	52155-49B4
LONG TAPERED GRASPER W/ ATRAUMATIC TEETH 20MM TIP 	5MM	24CM	52224-51B1	52224-51B8	52224-51B9	52224-51B10	52224-51B17	52224-51B3	52224-51B4
	5MM	33CM	52255-51B1	52255-51B8	52255-51B9	52255-51B10	52255-51B17	52255-51B3	52255-51B4
	5MM	36CM	52236-51B1	52236-51B8	52236-51B9	52236-51B10	52236-51B17	52236-51B3	52236-51B4
	5MM	45CM	52155-51B1	52155-51B8	52155-51B9	52155-51B10	52155-51B17	52155-51B3	52155-51B4
WAVE GRASPER, POINTED, SA 14MM TIP 	5MM	24CM	52224-54B1	52224-54B8	52224-54B9	52224-54B10	52224-54B17	52224-54B3	52224-54B4
	5MM	33CM	52255-54B1	52255-54B8	52255-54B9	52255-54B10	52255-54B17	52255-54B3	52255-54B4
	5MM	36CM	52236-54B1	52236-54B8	52236-54B9	52236-54B10	52236-54B17	52236-54B3	52236-54B4
	5MM	45CM	52155-54B1	52155-54B8	52155-54B9	52155-54B10	52155-54B17	52155-54B3	52155-54B4
"ACCESS" TYPE, FENESTRATED GRASPER 20MM TIP 	5MM	24CM	52224-191B1	52224-191B8	52224-191B9	52224-191B10	52224-191B17	52224-191B3	52224-191B4
	5MM	33CM	52255-191B1	52255-191B8	52255-191B9	52255-191B10	52255-191B17	52255-191B3	52255-191B4
	5MM	36CM	52236-191B1	52236-191B8	52236-191B9	52236-191B10	52236-191B17	52236-191B3	52236-191B4
	5MM	45CM	52155-191B1	52155-191B8	52155-191B9	52155-191B10	52155-191B17	52155-191B3	52155-191B4





5MM DISSECTORS & GRASPERS



MADE IN THE USA



BASIN SERIES:
ROTATABLE ONE-PIECE INSTRUMENT WITH
FLUSH PORT

TIP ID & LENGTH	HANDLE		TYPE 1	TYPE 8	TYPE 9	TYPE 10	TYPE 17	TYPE 3	TYPE 4
	DIAMETER	LENGTH							
		INSULATED HANDLES						NON-INSULATED	
"SOFT TOUCH" GRASPER, 22MM JAW, TEFLON INSERTS 22MM TIP 	5MM	24CM	52224-144B1	52224-144B8	52224-144B9	52224-144B10	52224-144B17	52224-144B3	52224-144B4
	5MM	33CM	52255-144B1	52255-144B8	52255-144B9	52255-144B10	52255-144B17	52255-144B3	52255-144B4
	5MM	36CM	52236-144B1	52236-144B8	52236-144B9	52236-144B10	52236-144B17	52236-144B3	52236-144B4
	5MM	45CM	52155-144B1	52155-144B8	52155-144B9	52155-144B10	52155-144B17	52155-144B3	52155-144B4
"SOFT TOUCH" GRASPER, 40MM JAW, TEFLON INSERTS 40MM TIP 	5MM	24CM	52224-145B1	52224-145B8	52224-145B9	52224-145B10	52224-145B17	52224-145B3	52224-145B4
	5MM	33CM	52255-145B1	52255-145B8	52255-145B9	52255-145B10	52255-145B17	52255-145B3	52255-145B4
	5MM	36CM	52236-145B1	52236-145B8	52236-145B9	52236-145B10	52236-145B17	52236-145B3	52236-145B4
	5MM	45CM	52155-145B1	52155-145B8	52155-145B9	52155-145B10	52155-145B17	52155-145B3	52155-145B4
TUBAL GRASPER, DA 10MM TIP 	5MM	24CM	52224-156B1	52224-156B8	52224-156B9	52224-156B10	52224-156B17	52224-156B3	52224-156B4
	5MM	33CM	52255-156B1	52255-156B8	52255-156B9	52255-156B10	52255-156B17	52255-156B3	52255-156B4
	5MM	36CM	52236-156B1	52236-156B8	52236-156B9	52236-156B10	52236-156B17	52236-156B3	52236-156B4
	5MM	45CM	52155-156B1	52155-156B8	52155-156B9	52155-156B10	52155-156B17	52155-156B3	52155-156B4
"DAVOL" TYPE, SCOOPED- JAW & GENTLY MASH TEETH 15MM TIP 	5MM	24CM	52224-90B1	52224-90B8	52224-90B9	52224-90B10	52224-90B17	52224-90B3	52224-90B4
	5MM	33CM	52255-90B1	52255-90B8	52255-90B9	52255-90B10	52255-90B17	52255-90B3	52255-90B4
	5MM	36CM	52236-90B1	52236-90B8	52236-90B9	52236-90B10	52236-90B17	52236-90B3	52236-90B4
	5MM	45CM	52155-90B1	52155-90B8	52155-90B9	52155-90B10	52155-90B17	52155-90B3	52155-90B4
"DAVOL" TYPE, SCOOPED- JAW & 2 X 3 FRONT TEETH 15MM TIP 	5MM	24CM	52224-190B1	52224-190B8	52224-190B9	52224-190B10	52224-190B17	52224-190B3	52224-190B4
	5MM	33CM	52255-190B1	52255-190B8	52255-190B9	52255-190B10	52255-190B17	52255-190B3	52255-190B4
	5MM	36CM	52236-190B1	52236-190B8	52236-190B9	52236-190B10	52236-190B17	52236-190B3	52236-190B4
	5MM	45CM	52155-190B1	52155-190B8	52155-190B9	52155-190B10	52155-190B17	52155-190B3	52155-190B4
DEBAKEY GRASPER, SA 22MM TIP 	5MM	24CM	52224-122B1	52224-122B8	52224-122B9	52224-122B10	52224-122B17	52224-122B3	52224-122B4
	5MM	33CM	52255-122B1	52255-122B8	52255-122B9	52255-122B10	52255-122B17	52255-122B3	52255-122B4
	5MM	36CM	52236-122B1	52236-122B8	52236-122B9	52236-122B10	52236-122B17	52236-122B3	52236-122B4
	5MM	45CM	52155-122B1	52155-122B8	52155-122B9	52155-122B10	52155-122B17	52155-122B3	52155-122B4





5MM SCISSORS & BIOPSY FORCEPS



MADE IN THE USA

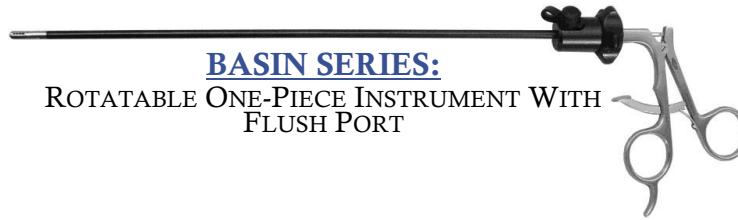

BASIN SERIES:

ROTATABLE ONE-PIECE INSTRUMENT WITH FLUSH PORT

TIP ID & LENGTH	HANDLE		TYPE 1	TYPE 5	TYPE 9	TYPE 17	TYPE 23	TYPE 3	TYPE 16
	DIAMETER	LENGTH							
			INSULATED HANDLES					NON-INSULATED	
HOOK SCISSORS, SA 10MM TIP 	5MM	24CM	52224-60B1	52224-60B8	52224-60B9	52224-60B17	52224-60B23	52224-60B3	52224-60B16
	5MM	33CM	52255-60B1	52255-60B8	52255-60B9	52255-60B17	52255-60B23	52255-60B3	52255-60B16
	5MM	36CM	52236-60B1	52236-60B8	52236-60B9	52236-60B17	52236-60B23	52236-60B3	52236-60B16
	5MM	45CM	52155-60B1	52155-60B8	52155-60B9	52155-60B17	52155-60B23	52155-60B3	52155-60B16
MICRO TIP SCISSORS, STRAIGHT, SA 5MM TIP 	5MM	24CM	52224-61B1	52224-61B8	52224-61B9	52224-61B17	52224-61B23	52224-61B3	52224-61B16
	5MM	33CM	52255-61B1	52255-61B8	52255-61B9	52255-61B17	52255-61B23	52255-61B3	52255-61B16
	5MM	36CM	52236-61B1	52236-61B8	52236-61B9	52236-61B17	52236-61B23	52236-61B3	52236-61B16
	5MM	45CM	52155-61B1	52155-61B8	52155-61B9	52155-61B17	52155-61B23	52155-61B3	52155-61B16
MICRO TIP SCISSORS, CURVED, SA 5MM TIP 	5MM	24CM	52224-62B1	52224-62B8	52224-62B9	52224-62B17	52224-62B23	52224-62B3	52224-62B16
	5MM	33CM	52255-62B1	52255-62B8	52255-62B9	52255-62B17	52255-62B23	52255-62B3	52255-62B16
	5MM	36CM	52236-62B1	52236-62B8	52236-62B9	52236-62B17	52236-62B23	52236-62B3	52236-62B16
	5MM	45CM	52155-62B1	52155-62B8	52155-62B9	52155-62B17	52155-62B23	52155-62B3	52155-62B16
METZENBAUM SCISSORS, STRAIGHT, LONG BLADE 20MM TIP 	5MM	24CM	52224-63B1	52224-63B8	52224-63B9	52224-63B17	52224-63B23	52224-63B3	52224-63B16
	5MM	33CM	52255-63B1	52255-63B8	52255-63B9	52255-63B17	52255-63B23	52255-63B3	52255-63B16
	5MM	36CM	52236-63B1	52236-63B8	52236-63B9	52236-63B17	52236-63B23	52236-63B3	52236-63B16
	5MM	45CM	52155-63B1	52155-63B8	52155-63B9	52155-63B17	52155-63B23	52155-63B3	52155-63B16
METZENBAUM SCISSORS, STRAIGHT, SHORT BLADE 12MM TIP 	5MM	24CM	52224-64B1	52224-64B8	52224-64B9	52224-64B17	52224-64B23	52224-64B3	52224-64B16
	5MM	33CM	52255-64B1	52255-64B8	52255-64B9	52255-64B17	52255-64B23	52255-64B3	52255-64B16
	5MM	36CM	52236-64B1	52236-64B8	52236-64B9	52236-64B17	52236-64B23	52236-64B3	52236-64B16
	5MM	45CM	52155-64B1	52155-64B8	52155-64B9	52155-64B17	52155-64B23	52155-64B3	52155-64B16
METZENBAUM SCISSORS, CURVED, LONG BLADE 16MM TIP 	5MM	24CM	52224-65B1	52224-65B8	52224-65B9	52224-65B17	52224-65B23	52224-65B3	52224-65B16
	5MM	33CM	52255-65B1	52255-65B8	52255-65B9	52255-65B17	52255-65B23	52255-65B3	52255-65B16
	5MM	36CM	52236-65B1	52236-65B8	52236-65B9	52236-65B17	52236-65B23	52236-65B3	52236-65B16
	5MM	45CM	52155-65B1	52155-65B8	52155-65B9	52155-65B17	52155-65B23	52155-65B3	52155-65B16
METZENBAUM SCISSORS, WONDERCUT, CURVED BLADE 20MM TIP 	5MM	24CM	52224-265B1	52224-265B8	52224-265B9	52224-265B17	52224-265B23	52224-265B3	52224-265B16
	5MM	33CM	52255-265B1	52255-265B8	52255-265B9	52255-265B17	52255-265B23	52255-265B3	52255-265B16
	5MM	36CM	52236-265B1	52236-265B8	52236-265B9	52236-265B17	52236-265B23	52236-265B3	52236-265B16
	5MM	45CM	52155-265B1	52155-265B8	52155-265B9	52155-265B17	52155-265B23	52155-265B3	52155-265B16





5MM SCISSORS & BIOPSY FORCEPS



MADE IN THE USA

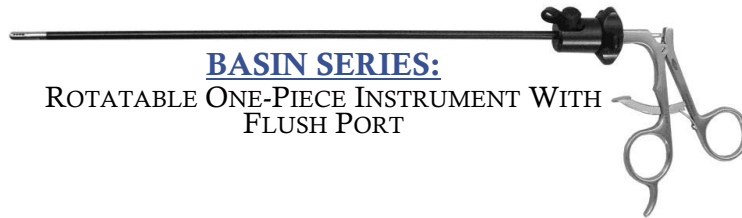

BASIN SERIES:
ROTATABLE ONE-PIECE INSTRUMENT WITH
FLUSH PORT

TIP ID & LENGTH	HANDLE		TYPE 1	TYPE 5	TYPE 9	TYPE 17	TYPE 23	TYPE 3	TYPE 16
	DIAMETER	LENGTH							
			INSULATED HANDLES					NON-INSULATED	
METZENBAUM SCISSORS, CURVED, SHORT BLADE 12MM TIP 	5MM	24CM	52224-66B1	52224-66B8	52224-66B9	52224-66B17	52224-66B23	52224-66B3	52224-66B16
	5MM	33CM	52255-66B1	52255-66B8	52255-66B9	52255-66B17	52255-66B23	52255-66B3	52255-66B16
	5MM	36CM	52236-66B1	52236-66B8	52236-66B9	52236-66B17	52236-66B23	52236-66B3	52236-66B16
	5MM	45CM	52155-66B1	52155-66B8	52155-66B9	52155-66B17	52155-66B23	52155-66B3	52155-66B16
PERITONEAL SCISSORS, SA 15MM TIP 	5MM	24CM	52224-67B1	52224-67B8	52224-67B9	52224-67B17	52224-67B23	52224-67B3	52224-67B16
	5MM	33CM	52255-67B1	52255-67B8	52255-67B9	52255-67B17	52255-67B23	52255-67B3	52255-67B16
	5MM	36CM	52236-67B1	52236-67B8	52236-67B9	52236-67B17	52236-67B23	52236-67B3	52236-67B16
	5MM	45CM	52155-67B1	52155-67B8	52155-67B9	52155-67B17	52155-67B23	52155-67B3	52155-67B16
BIOPSY SPOON FORCEPS W/ TOOTH 10MM TIP 	5MM	24CM	52224-79B1	52224-79B8	52224-79B9	52224-79B17	52224-79B23	52224-79B3	52224-79B16
	5MM	33CM	52255-79B1	52255-79B8	52255-79B9	52255-79B17	52255-79B23	52255-79B3	52255-79B16
	5MM	36CM	52236-79B1	52236-79B8	52236-79B9	52236-79B17	52236-79B23	52236-79B3	52236-79B16
	5MM	45CM	52155-79B1	52155-79B8	52155-79B9	52155-79B17	52155-79B23	52155-79B3	52155-79B16
BIOPSY SPOON FORCEPS, SHORT, SA 10MM TIP 	5MM	24CM	52224-69B1	52224-69B8	52224-69B9	52224-69B17	52224-69B23	52224-69B3	52224-69B16
	5MM	33CM	52255-69B1	52255-69B8	52255-69B9	52255-69B17	52255-69B23	52255-69B3	52255-69B16
	5MM	36CM	52236-69B1	52236-69B8	52236-69B9	52236-69B17	52236-69B23	52236-69B3	52236-69B16
	5MM	45CM	52155-69B1	52155-69B8	52155-69B9	52155-69B17	52155-69B23	52155-69B3	52155-69B16
POINTED BIOPSY SPOON FORCEPS, SA 10MM TIP 	5MM	24CM	52224-305B1	52224-305B8	52224-305B9	52224-305B17	52224-305B23	52224-305B3	52224-305B16
	5MM	33CM	52255-305B1	52255-305B8	52255-305B9	52255-305B17	52255-305B23	52255-305B3	52255-305B16
	5MM	36CM	52236-305B1	52236-305B8	52236-305B9	52236-305B17	52236-305B23	52236-305B3	52236-305B16
	5MM	45CM	52155-305B1	52155-305B8	52155-305B9	52155-305B17	52155-305B23	52155-305B3	52155-305B16
BIOPSY SPOON FORCEPS, DA 10MM TIP 	5MM	24CM	52224-70B1	52224-70B8	52224-70B9	52224-70B17	52224-70B23	52224-70B3	52224-70B16
	5MM	33CM	52255-70B1	52255-70B8	52255-70B9	52255-70B17	52255-70B23	52255-70B3	52255-70B16
	5MM	36CM	52236-70B1	52236-70B8	52236-70B9	52236-70B17	52236-70B23	52236-70B3	52236-70B16
	5MM	45CM	52155-70B1	52155-70B8	52155-70B9	52155-70B17	52155-70B23	52155-70B3	52155-70B16
BIOPSY SPOON FORCEPS, W/ TOOTH (SEMM-TYPE), D/A 10MM TIP 	5MM	24CM	52224-68B1	52224-68B8	52224-68B9	52224-68B17	52224-68B23	52224-68B3	52224-68B16
	5MM	33CM	52255-68B1	52255-68B8	52255-68B9	52255-68B17	52255-68B23	52255-68B3	52255-68B16
	5MM	36CM	52236-68B1	52236-68B8	52236-68B9	52236-68B17	52236-68B23	52236-68B3	52236-68B16
	5MM	45CM	52155-68B1	52155-68B8	52155-68B9	52155-68B17	52155-68B23	52155-68B3	52155-68B16





5MM SCISSORS & BIOPSY FORCEPS





MADE IN THE USA



BASIN SERIES:

ROTATABLE ONE-PIECE INSTRUMENT WITH FLUSH PORT

TIP ID & LENGTH	HANDLE ID		TYPE 1	TYPE 5	TYPE 9	TYPE 17	TYPE 23	TYPE 3	TYPE 16
	DIAMETER	LENGTH							
			INSULATED HANDLES					NON-INSULATED HANDLES	
BIOPSY PUNCH, SA 10MM TIP 	5MM	24CM	52224-71B1	52224-71B8	52224-71B9	52224-71B17	52224-71B23	52224-71B3	52224-71B16
	5MM	33CM	52255-71B1	52255-71B8	52255-71B9	52255-71B17	52255-71B23	52255-71B3	52255-71B16
	5MM	36CM	52236-71B1	52236-71B8	52236-71B9	52236-71B17	52236-71B23	52236-71B3	52236-71B16
	5MM	45CM	52155-71B1	52155-71B8	52155-71B9	52155-71B17	52155-71B23	52155-71B3	52155-71B16
BIOPSY PUNCH W/ TOOTH, SA 10MM TIP 	5MM	24CM	52224-72B1	52224-72B8	52224-72B9	52224-72B17	52224-72B23	52224-72B3	52224-72B16
	5MM	33CM	52255-72B1	52255-72B8	52255-72B9	52255-72B17	52255-72B23	52255-72B3	52255-72B16
	5MM	36CM	52236-72B1	52236-72B8	52236-72B9	52236-72B17	52236-72B23	52236-72B3	52236-72B16
	5MM	45CM	52155-72B1	52155-72B8	52155-72B9	52155-72B17	52155-72B23	52155-72B3	52155-72B16





10MM DISSECTORS & GRASPERS



MADE IN THE USA



BASIN SERIES:

ROTATABLE ONE-PIECE INSTRUMENT WITH FLUSH PORT

TIP ID & LENGTH	HANDLE ID		TYPE 1	TYPE 8	TYPE 9	TYPE 10	TYPE 17	TYPE 3	TYPE 4
	DIAMETER	LENGTH							
			INSULATED HANDLES					NON-INSULATED	
MARYLAND DISSECTOR 18MM TIP 	10MM	33CM	52102-06B1	52102-06B8	52102-06B9	52102-06B10	52102-06B17	52102-06B3	52102-06B4
	10MM	36CM	52103-06B1	52103-06B8	52103-06B9	52103-06B10	52103-06B17	52103-06B3	52103-06B4
	10MM	45CM	52101-06B1	52101-06B8	52101-06B9	52101-06B10	52101-06B17	52101-06B3	52101-06B4
RIGHT ANGLE MIXTER LONG TEFON INSERTS 22MM TIP 	10MM	33CM	52102-07B1	52102-07B8	52102-07B9	52102-07B10	52102-07B17	52102-07B3	52102-07B4
	10MM	36CM	52103-07B1	52103-07B8	52103-07B9	52103-07B10	52103-07B17	52103-07B3	52103-07B4
	10MM	45CM	52101-07B1	52101-07B8	52101-07B9	52101-07B10	52101-07B17	52101-07B3	52101-07B4
RIGHT ANGLE MIXTER, SHORT 12MM TIP 	10MM	33CM	52102-59B1	52102-59B8	52102-59B9	52102-59B10	52102-59B17	52102-59B3	52102-59B4
	10MM	36CM	52103-59B1	52103-59B8	52103-59B9	52103-59B10	52103-59B17	52103-59B3	52103-59B4
	10MM	45CM	52101-59B1	52101-59B8	52101-59B9	52101-59B10	52101-59B17	52101-59B3	52101-59B4
45° ANGLED MIXTER 20MM TIP 	10MM	33CM	52102-08B1	52102-08B8	52102-08B9	52102-08B10	52102-08B17	52102-08B3	52102-08B4
	10MM	36CM	52103-08B1	52103-08B8	52103-08B9	52103-08B10	52103-08B17	52103-08B3	52103-08B4
	10MM	45CM	52101-08B1	52101-08B8	52101-08B9	52101-08B10	52101-08B17	52101-08B3	52101-08B4
BABCOCK GRASPER FENESTRATED TIP 30MM TIP 	10MM	33CM	52102-16A1	52102-16B8	52102-16B9	52102-16B10	52102-16B17	52102-16B3	52102-16B4
	10MM	36CM	52103-16B1	52103-16B8	52103-16B9	52103-16B10	52103-16B17	52103-16B3	52103-16B4
	10MM	45CM	52101-16B1	52101-16B8	52101-16B9	52101-16B10	52101-16B17	52101-16B3	52101-16B4
ALLIS GRASPER STD VERSION 30MM TIP 	10MM	33CM	52102-21B1	52102-21B8	52102-21B9	52102-21B10	52102-21B17	52102-21B3	52102-21B4
	10MM	36CM	52103-21B1	52103-21B8	52103-21B9	52103-21B10	52103-21B17	52103-21B3	52103-21B4
	10MM	45CM	52101-21B1	52101-21B8	52101-21B9	52101-21B10	52101-21B17	52101-21B3	52101-21B4
DEBAKEY GRASPER 40MM TIP 	10MM	33CM	52102-22B1	52102-22B8	52102-22B9	52102-22B10	52102-22B17	52102-22B3	52102-22B4
	10MM	36CM	52103-22B1	52103-22B8	52103-22B9	52103-22B10	52103-22B17	52103-22B3	52103-22B4
	10MM	45CM	52101-22B1	52101-22B8	52101-22B9	52101-22B10	52101-22B17	52101-22B3	52101-22B4
DEBAKEY GRASPER 60MM TIP 	10MM	33CM	52102-23B1	52102-23B8	52102-23B9	52102-23B10	52102-23B17	52102-23B3	52102-23B4
	10MM	36CM	52103-23B1	52103-23B8	52103-23B9	52103-23B10	52103-23B17	52103-23B3	52103-23B4
	10MM	45CM	52101-23B1	52101-23B8	52101-23B9	52101-23B10	52101-23B17	52101-23B3	52101-23B4
CLAW GRASPER, 2 X 3 TEETH, SA 20MM TIP 	10MM	33CM	52102-36B1	52102-36B8	52102-36B9	52102-36B10	52102-36B17	52102-36B3	52102-36B4
	10MM	36CM	52103-36B1	52103-36B8	52103-36B9	52103-36B10	52103-36B17	52103-36B3	52103-36B4
	10MM	45CM	52101-36B1	52101-36B8	52101-36B9	52101-36B10	52101-36B17	52101-36B3	52101-36B4





10MM DISSECTORS & GRASPERS



MADE IN THE USA



BASIN SERIES:

ROTATABLE ONE-PIECE INSTRUMENT WITH FLUSH PORT

TIP ID & LENGTH	HANDLE		TYPE 1	TYPE 8	TYPE 9	TYPE 10	TYPE 17	TYPE 3	TYPE 4
	DIAMETER	LENGTH							
			INSULATED HANDLES					NON-INSULATED	
SCHROEDER TEN, SINGLE TOOTH 25MM TIP 	10MM	33CM	52102-45B1	52102-45B8	52102-45B9	52102-45B10	52102-45B17	52102-45B3	52102-45B4
	10MM	36CM	52103-45B1	52103-45B8	52103-45B9	52103-45B10	52103-45B17	52103-45B3	52103-45B4
	10MM	45CM	52101-45B1	52101-45B8	52101-45B9	52101-45B10	52101-45B17	52101-45B3	52101-45B4
US BABCOCK, SPRING TENSION, ATRAUMATIC 22MM TIP 	10MM	33CM	52102-17B1	52102-17B8	52102-17B9	52102-17B10	52102-17B17	52102-17B3	52102-17B4
	10MM	36CM	52103-17B1	52103-17B8	52103-17B9	52103-17B10	52103-17B17	52103-17B3	52103-17B4
	10MM	45CM	52101-17B1	52101-17B8	52101-17B9	52101-17B10	52101-17B17	52101-17B3	52101-17B4
DUVAL GRASPER, AXIAL SERRATIONS 40MM TIP 	10MM	33CM	52102-26B1	52102-26B8	52102-26B9	52102-26B10	52102-26B17	52102-26B3	52102-26B4
	10MM	36CM	52103-26B1	52103-26B8	52103-26B9	52103-26B10	52103-26B17	52103-26B3	52103-26B4
	10MM	45CM	52101-26B1	52101-26B8	52101-26B9	52101-26B10	52101-26B17	52101-26B3	52101-26B4
STRONG ATRAUMATIC CLAMP, STRAIGHT JAW, 40MM TIP 	10MM	33CM	52102-46B1	52102-46B8	52102-46B9	52102-46B10	52102-46B17	52102-46B3	52102-46B4
	10MM	36CM	52103-46B1	52103-46B8	52103-46B9	52103-46B10	52103-46B17	52103-46B3	52103-46B4
	10MM	45CM	52101-46B1	52101-46B8	52101-46B9	52101-46B10	52101-46B17	52101-46B3	52101-46B4
STRONG ATRAUMATIC CLAMP, CURVED JAW, 40MM TIP 	10MM	33CM	52102-47B1	52102-47B8	52102-47B9	52102-47B10	52102-47B17	52102-47B3	52102-47B4
	10MM	36CM	52103-47B1	52103-47B8	52103-47B9	52103-47B10	52103-47B17	52103-47B3	52103-47B4
	10MM	45CM	52101-47B1	52101-47B8	52101-47B9	52101-47B10	52101-47B17	52101-47B3	52101-47B4
ANVIL GRAPER TO GRASP & HOLD ANVIL, 10MM TIP 	10MM	33CM	52102-20B1	52102-20B8	52102-20B9	52102-20B10	52102-20B17	52102-20B3	52102-20B4
	10MM	36CM	52103-20B1	52103-20B8	52103-20B9	52103-20B10	52103-20B17	52103-20B3	52103-20B4
	10MM	45CM	52101-20B1	52101-20B8	52101-20B9	52101-20B10	52101-20B17	52101-20B3	52101-20B4





10MM SCISSORS & BIOPSY FORCEPS



MADE IN THE USA

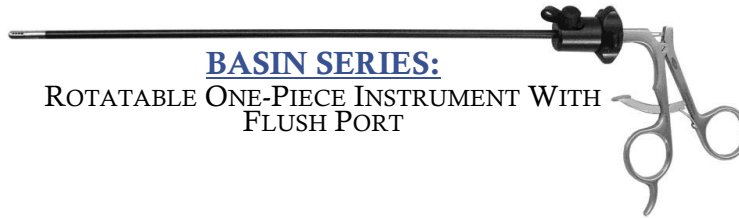

BASIN SERIES:
ROTATABLE ONE-PIECE INSTRUMENT WITH
FLUSH PORT

TIP ID & LENGTH	HANDLE ID		TYPE 1	TYPE 5	TYPE 9	TYPE 17	TYPE 23	TYPE 3	TYPE 16
	DIAMETER	LENGTH							
			INSULATED HANDLES					NON-INSULATED	
STRAIGHT SCISSORS, SA 20MM TIP 	10MM	33CM	52102-64B1	52102-64B5	52102-64B9	52102-64B17	52102-64B23	52102-64B3	52102-64B16
	10MM	36CM	52103-64B1	52103-64B5	52103-64B9	52103-64B17	52103-64B23	52103-64B3	52103-64B16
	10MM	45CM	52101-64B1	52101-64B5	52101-64B9	52101-64B17	52101-64B23	52101-64B3	52101-64B16
CURVED SCISSORS, DA 20MM TIP 	10MM	33CM	52102-66B1	52102-66B5	52102-66B9	52102-66B17	52102-66B23	52102-66B3	52102-66B16
	10MM	36CM	52103-66B1	52103-66B5	52103-66B9	52103-66B17	52103-66B23	52103-66B3	52103-66B16
	10MM	45CM	52101-66B1	52101-66B5	52101-66B9	52101-66B17	52101-66B23	52101-66B3	52101-66B16
BIOPSY SPOON FORCEPS, SHORT, SA, 10MM TIP 	10MM	33CM	52102-37B1	52102-37B5	52102-37B9	52102-37B17	52102-37B23	52102-37B3	52102-37B16
	10MM	36CM	52103-37B1	52103-37B5	52103-37B9	52103-37B17	52103-37B23	52103-37B3	52103-37B16
	10MM	45CM	52101-37B1	52101-37B5	52101-37B9	52101-37B17	52101-37B23	52101-37B3	52101-37B16
BIOPSY SPOON FORCEPS, LONG, SA, 25MM TIP 	10MM	33CM	52102-38B1	52102-38B5	52102-38B9	52102-38B17	52102-38B23	52102-38B3	52102-38B16
	10MM	36CM	52103-38B1	52103-38B5	52103-38B9	52103-38B17	52103-38B23	52103-38B3	52103-38B16
	10MM	45CM	52101-38B1	52101-38B5	52101-38B9	52101-38B17	52101-38B23	52101-38B3	52101-38B16



SUMMIT SERIES



THE *SUMMIT SERIES* 5MM MODULAR, THREE-PIECE DETACHABLE INSTRUMENTS IS OUR MOST EXTENSIVE LINE OF LAPAROSCOPIC INSTRUMENTS, OFFERING OVER 2000 DIFFERENT COMBINATIONS FOR THE MOST PRECISE INSTRUMENTATION NEEDED FOR ANY PROCEDURE. OUR THREE-PIECE MODULAR INSTRUMENTS ARE DESIGNED TO COME APART FOR SUPERIOR CLEANING.

THEY ARE ALSO COMPLETELY INTERCHANGEABLE WITH ANY OF OUR LAPAROSCOPIC HANDLES GIVING HOSPITALS & SURGERY CENTERS THE FLEXIBILITY TO QUICKLY ASSEMBLE INSTRUMENTS WITHOUT HAVING TO MATCH UP EVERY INSERT, SHAFT, & HANDLE.

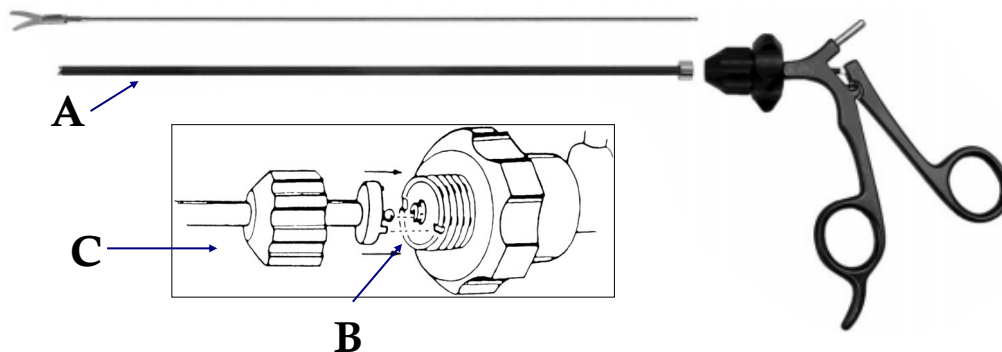

ASSEMBLY:

1. TURN THE **TIP (C)** CLOCKWISE INTO THE SHAFT
2. SET THE HANDLE IN THE OPEN POSITION & ENGAGE THE **BALL (B)** OF **INNER ROD** INTO ITS FIXATION IN THE HANDLE PORT.
3. TURN MAIN **SCREW CAP (A)** CLOCKWISE UNTIL IT ENGAGES THE HANDLE.



SUMMIT SERIES OUTER TUBES & ACCESSORIES



MADE IN THE USA



5MM INSULATED SHAFT

ITEM NO.	DESCRIPTION
52555-49	5MM X 24CM
52555-45	5MM X 33CM
52555-39	5MM X 36CM
52555-47	5MM X 45CM



52555-47-01

SHAFT LOCKING
CAP

5MM NON-INSULATED SHAFT

ITEM NO.	DESCRIPTION
52555-32	5MM X 24CM
52555-51	5MM X 33CM
52555-34	5MM X 36CM
52555-35	5MM X 45CM

REUSABLE CABLES FOR MONOPOLAR INSTRUMENTS & GENERATORS



GENERATOR



INSTRUMENT END

52005-31

4MM DIA. PLUG (UNIT) &
4MM DIA. FEMALE INST. PLUG



10MM INSULATED SHAFT

ITEM NO.	DESCRIPTION
52555-50	10MM X 24CM
52555-46	10MM X 33CM
52555-56	10MM X 36CM
52555-48	10MM X 45CM



GENERATOR



INSTRUMENT END

52005-32

8MM DIA. "BOVIE" PLUG
(UNIT) & 4MM DIA. FEMALE
INST. PLUG

10MM NON-INSULATED SHAFT

ITEM NO.	DESCRIPTION
52555-55	10MM X 24CM
52555-52	10MM X 33CM
52555-53	10MM X 36CM
52555-54	10M X 45CM





HANDLES: NON CONDUCTIVE CARBON FIBER



MADE IN THE USA

52555-40-01

INSULATED STAINLESS STEEL W/ RF POST
(TYPE 1)



52555-40-02

INSULATED STAINLESS STEEL W/ RF-POST
& RATCHET
(TYPE 2)

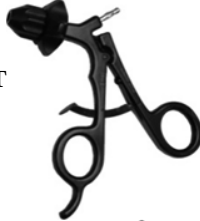

52555-40-05

INSULATED W/ RF-POST & RATCHET
(TYPE 5)



52555-40-06

LIGHTWEIGHT CARBON FIBER W/ RF-POST
& ON DEMAND ON/OFF RATCHET
(TYPE 6)



52555-40-07

LIGHTWEIGHT CARBON-FIBER W/ RF POST,
RATCHET / RATCHET
DEFEATING (TYPE 7)



52555-40-08

LIGHTWEIGHT CARBON-FIBER W/ RF POST,
ON DEMAND FRENCH ON/OFF RATCHET
(TYPE 8)



52555-40-09

LIGHTWEIGHT CARBON-FIBER W/ RF POST,
W/ LARGE FINGER LOOPS
(TYPE 9)



52555-40-10

LIGHTWEIGHT CARBON-FIBER W/ RF POST,
RATCHET/RATCHET DEFEATING W/ LARGE
FINGER LOOPS
(TYPE 10)



52555-40-14

INSULATED STAINLESS STEEL LINVATEC-
WECK STYLE W/ LONG SHANKS
(TYPE 14)



52555-40-17

LIGHTWEIGHT CARBON FIBER W/ RF POST
(TYPE 17)



52555-40-18

LIGHTWEIGHT CARBON-FIBER W/ RF POST,
RATCHET / RATCHET DEFEATING
(TYPE 18)



52555-40-23

LIGHTWEIGHT THERMO-PLASTIC W/ RF
POST, NON-RATCHET
(TYPE 23)



52555-40-24

LIGHTWEIGHT THERMO-PLASTIC W/ RF
POST, W/ RATCHET (TYPE 24)





HANDLES: NON-INSULATED



MADE IN THE USA

52555-40-03
NON-INSULATED STAINLESS STEEL
(TYPE 3)



52555-40-21
STAINLESS STEEL AXIAL HANDLE V-
SHAPED W/ SPREADING SPRING &
THUMB RELEASE RATCHET
(TYPE 21)



52555-40-04
NON-INSULATED STAINLESS STEEL W/
RATCHET
(TYPE 4)



52555-40-30
STAINLESS STEEL AXIAL HANDLE
V-SHAPED W/ SPREADING SPRING, NON-
RATCHET
(TYPE 30)



52555-40-11
NON-INSULATED RING AXIAL HANDLE
(TYPE 11)

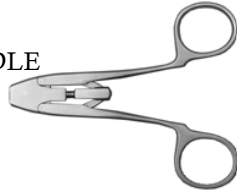

52555-40-19
STAINLESS STEEL AXIAL HANDLE
V-SHAPED, ANGLED DOWN W/
SPREADING SPRING & RATCHET
(TYPE 19)



52555-40-12
NON-INSULATED RING AXIAL HANDLE
W/ RATCHET
(TYPE 12)



52555-40-31
STAINLESS STEEL AXIAL
HANDLE V-SHAPED, ANGLED DOWN W/
SPREADING SPRING, NON-RATCHET
(TYPE 31)



52555-40-13
STAINLESS STEEL AXIAL HANDLE
W/ PRECISE ENGAGEMENT RATCHET
(TYPE 13)



52555-40-26
ALUMINUM AXIAL HANDLE, SINGLE
ACTION W/ RATCHET
(TYPE 26)



52555-40-15
NON-INSULATED STAINLESS STEEL
LINAVEC-WECK STYLE W/ QUICK RELEASE
RATCHET & LONG SHANKS
(TYPE 15)



52555-40-28
ALUMINUM AXIAL HANDLE, SINGLE
ACTION, NON-RATCHET
(TYPE 28)



52555-40-16
NON-INSULATED STAINLESS STEEL W/
SPRING ASSIST CLOSING
(TYPE 16)



52555-40-27
ALUMINUM AXIAL HANDLE, ANGLED
DOWN, SINGLE ACTION W/ RATCHET
(TYPE 27)



52555-40-29
ALUMINUM AXIAL HANDLE, ANGLED
DOWN, SINGLE ACTION, NON-RATCHET
(TYPE 29)













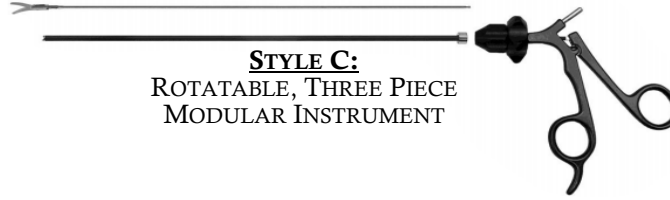



5MM DISSECTORS & GRASPERS

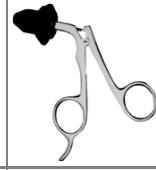

MADE IN THE USA

STYLE C:
ROTATABLE, THREE PIECE
MODULAR INSTRUMENT



TIP ID & LENGTH	HANDLE		INSERT ONLY	TYPE 1	TYPE 9	TYPE 10	TYPE 17	TYPE 3	TYPE 4
	DIAMETER	LENGTH							
				INSULATED HANDLES				NON-INSULATED	
MICRO REDDICK OLSEN 12MM TIP 	5MM	24CM	52224-01I	52224-01C1	52224-01C9	52224-01C10	52224-01C17	52224-01C3	52224-01C4
	5MM	33CM	52255-01I	52255-01C1	52255-01C9	52255-01C10	52255-01C17	52255-01C3	52255-01C4
	5MM	36CM	52236-01I	52236-01C1	52236-01C9	52236-01C10	52236-01C17	52236-01C3	52236-01C4
	5MM	45CM	52155-01I	52155-01C1	52155-01C9	52155-01C10	52155-01C17	52155-01C3	52155-01C4
STANDARD GRASPER W/ SPOON 12MM TIP 	5MM	24CM	52224-02I	52224-02C1	52224-02C9	52224-02C10	52224-02C17	52224-02C3	52224-02C4
	5MM	33CM	52255-02I	52255-02C1	52255-02C9	52255-02C10	52255-02C17	52255-02C3	52255-02C4
	5MM	36CM	52236-02I	52236-02C1	52236-02C9	52236-02C10	52236-02C17	52236-02C3	52236-02C4
	5MM	45CM	52155-02I	52155-02C1	52155-02C9	52155-02C10	52155-02C17	52155-02C3	52155-02C4
STANDARD GRASPER W/ SPOON, LONG 20MM TIP 	5MM	24CM	52224-52I	52224-52C1	52224-52C9	52224-52C10	52224-52C17	52224-52C3	52224-52C4
	5MM	33CM	52255-52I	52255-52C1	52255-52C9	52255-52C10	52255-52C17	52255-52C3	52255-52C4
	5MM	36CM	52236-52I	52236-52C1	52236-52C9	52236-52C10	52236-52C17	52236-52C3	52236-52C4
	5MM	45CM	52155-52I	52155-52C1	52155-52C9	52155-52C10	52155-52C17	52155-52C3	52155-52C4
STANDARD GRASPER 12MM TIP 	5MM	24CM	52224-03I	52224-03C1	52224-03C9	52224-03C10	52224-03C17	52224-03C3	52224-03C4
	5MM	33CM	52255-03I	52255-03C1	52255-03C9	52255-03C10	52255-03C17	52255-03C3	52255-03C4
	5MM	36CM	52236-03I	52236-03C1	52236-03C9	52236-03C10	52236-03C17	52236-03C3	52236-03C4
	5MM	45CM	52155-03I	52155-03C1	52155-03C9	52155-03C10	52155-03C17	52155-03C3	52155-03C4
BULLET-NOSE GRASPER W/ SPOON 12MM TIP 	5MM	24CM	52224-04I	52224-04C1	52224-04C9	52224-04C10	52224-04C17	52224-04C3	52224-04C4
	5MM	33CM	52255-04I	52255-04C1	52255-04C9	52255-04C10	52255-04C17	52255-04C3	52255-04C4
	5MM	36CM	52236-04I	52236-04C1	52236-04C9	52236-04C10	52236-04C17	52236-04C3	52236-04C4
	5MM	45CM	52155-04I	52155-04C1	52155-04C9	52155-04C10	52155-04C17	52155-04C3	52155-04C4
TAPERED DOLPHIN-NOSE 15MM TIP 	5MM	24CM	52224-05I	52224-05C1	52224-05C9	52224-05C10	52224-05C17	52224-05C3	52224-05C4
	5MM	33CM	52255-05I	52255-05C1	52255-05C9	52255-05C10	52255-05C17	52255-05C3	52255-05C4
	5MM	36CM	52236-05I	52236-05C1	52236-05C9	52236-05C10	52236-05C17	52236-05C3	52236-05C4
	5MM	45CM	52155-05I	52155-05C1	52155-05C9	52155-05C10	52155-05C17	52155-05C3	52155-05C4
TAPERED DOLPHIN-NOSE W/ SPOON 15MM TIP 	5MM	24CM	52224-105I	52224-105C1	52224-105C9	52224-105C10	52224-105C17	52224-105C3	52224-105C4
	5MM	33CM	52255-105I	52255-105C1	52255-105C9	52255-105C10	52255-105C17	52255-105C3	52255-105C4
	5MM	36CM	52236-105I	52236-105C1	52236-105C9	52236-105C10	52236-105C17	52236-105C3	52236-105C4
	5MM	45CM	52155-105I	52155-105C1	52155-105C9	52155-105C10	52155-105C17	52155-105C3	52155-105C4

















5MM DISSECTORS & GRASPERS

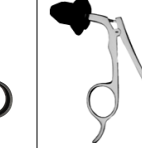
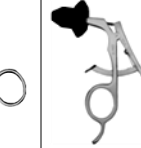

MADE IN THE USA

STYLE C:
ROTATABLE, THREE PIECE
MODULAR INSTRUMENT



TIP ID & LENGTH	HANDLE		INSERT ONLY	TYPE 1	TYPE 9	TYPE 10	TYPE 17	TYPE 3	TYPE 4
	DIAMETER	LENGTH							
				INSULATED HANDLES				NON-INSULATED	
TAPERED DOLPHIN-NOSE W/ LONG SPOON 22MM TIP 	5MM	24CM	52224-205I	52224-205C1	52224-205C9	52224-205C10	52224-205C17	52224-205C3	52224-205C4
	5MM	33CM	52255-205I	52255-205C1	52255-205C9	52255-205C10	52255-205C17	52255-205C3	52255-205C4
	5MM	36CM	52236-205I	52236-205C1	52236-205C9	52236-205C10	52236-205C17	52236-205C3	52236-205C4
	5MM	45CM	52155-205I	52155-205C1	52155-205C9	52155-205C10	52155-205C17	52155-205C3	52155-205C4
MARYLAND DISSECTOR 18MM TIP 	5MM	24CM	52224-06I	52224-06C1	52224-06C9	52224-06C10	52224-06C17	52224-06C3	52224-06C4
	5MM	33CM	52255-06I	52255-06C1	52255-06C9	52255-06C10	52255-06C17	52255-06C3	52255-06C4
	5MM	36CM	52236-06I	52236-06C1	52236-06C9	52236-06C10	52236-06C17	52236-06C3	52236-06C4
	5MM	45CM	52155-06I	52155-06C1	52155-06C9	52155-06C10	52155-06C17	52155-06C3	52155-06C4
TAPERED MARYLAND DISSECTOR 18MM TIP 	5MM	24CM	52224-106I	52224-106C1	52224-106C9	52224-106C10	52224-106C17	52224-106C3	52224-106C4
	5MM	33CM	52255-106I	52255-106C1	52255-106C9	52255-106C10	52255-106C17	52255-106C3	52255-106C4
	5MM	36CM	52236-106I	52236-106C1	52236-106C9	52236-106C10	52236-106C17	52236-106C3	52236-106C4
	5MM	45CM	52155-106I	52155-106C1	52155-106C9	52155-106C10	52155-106C17	52155-106C3	52155-106C4
SHORT MARYLAND DISSECTOR 15MM TIP 	5MM	24CM	52224-206I	52224-206C1	52224-206C9	52224-206C10	52224-206C17	52224-206C3	52224-206C4
	5MM	33CM	52255-206I	52255-206C1	52255-206C9	52255-206C10	52255-206C17	52255-206C3	52255-206C4
	5MM	36CM	52236-206I	52236-206C1	52236-206C9	52236-206C10	52236-206C17	52236-206C3	52236-206C4
	5MM	45CM	52155-206I	52155-206C1	52155-206C9	52155-206C10	52155-206C17	52155-206C3	52155-206C4
RIGHT ANGLE MIXTER, LONG 22MM TIP 	5MM	24CM	52224-07I	52224-07C1	52224-07C9	52224-07C10	52224-07C17	52224-07C3	52224-07C4
	5MM	33CM	52255-07I	52255-07C1	52255-07C9	52255-07C10	52255-07C17	52255-07C3	52255-07C4
	5MM	36CM	52236-07I	52236-07C1	52236-07C9	52236-07C10	52236-07C17	52236-07C3	52236-07C4
	5MM	45CM	52155-07I	52155-07C1	52155-07C9	52155-07C10	52155-07C17	52155-07C3	52155-07C4
RIGHT ANGLE MIXTER, SHORT 12MM TIP 	5MM	24CM	52224-59I	52224-59C1	52224-59C9	52224-59C10	52224-59C17	52224-59C3	52224-59C4
	5MM	33CM	52255-59I	52255-59C1	52255-59C9	52255-59C10	52255-59C17	52255-59C3	52255-59C4
	5MM	36CM	52236-59I	52236-59C1	52236-59C9	52236-59C10	52236-59C17	52236-59C3	52236-59C4
	5MM	45CM	52155-59I	52155-59C1	52155-59C9	52155-59C10	52155-59C17	52155-59C3	52155-59C4
45° ANGLED MIXTER 20MM TIP 	5MM	24CM	52224-08I	52224-08C1	52224-08C9	52224-08C10	52224-08C17	52224-08C3	52224-08C4
	5MM	33CM	52255-08I	52255-08C1	52255-08C9	52255-08C10	52255-08C17	52255-08C3	52255-08C4
	5MM	36CM	52236-08I	52236-08C1	52236-08C9	52236-08C10	52236-08C17	52236-08C3	52236-08C4
	5MM	45CM	52155-08I	52155-08C1	52155-08C9	52155-08C10	52155-08C17	52155-08C3	52155-08C4













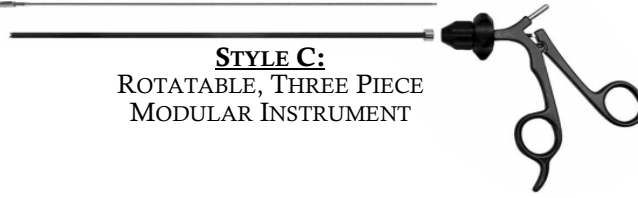



5MM DISSECTORS & GRASPERS

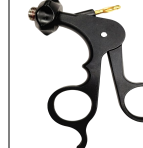
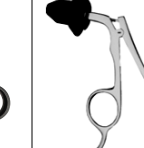
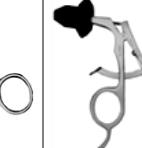

MADE IN THE USA

STYLE C:
ROTATABLE, THREE PIECE
MODULAR INSTRUMENT



TIP ID & LENGTH	HANDLE		INSERT ONLY	TYPE 1	TYPE 9	TYPE 10	TYPE 17	TYPE 3	TYPE 4
	DIAMETER	LENGTH							
				INSULATED HANDLES				NON-INSULATED	
DUCKBILL GRASPER 12MM TIP 	5MM	24CM	52224-09I	52224-09C1	52224-09C9	52224-09C10	52224-09C17	52224-09C3	52224-09C4
	5MM	33CM	52255-09I	52255-09C1	52255-09C9	52255-09C10	52255-09C17	52255-09C3	52255-09C4
	5MM	36CM	52236-09I	52236-09C1	52236-09C9	52236-09C10	52236-09C17	52236-09C3	52236-09C4
	5MM	45CM	52155-09I	52155-09C1	52155-09C9	52155-09C10	52155-09C17	52155-09C3	52155-09C4
NEEDLE-NOSE GRASPER 20MM TIP 	5MM	24CM	52224-10I	52224-10C1	52224-10C9	52224-10C10	52224-10C17	52224-10C3	52224-10C4
	5MM	33CM	52255-10I	52255-10C1	52255-10C9	52255-10C10	52255-10C17	52255-10C3	52255-10C4
	5MM	36CM	52236-10I	52236-10C1	52236-10C9	52236-10C10	52236-10C17	52236-10C3	52236-10C4
	5MM	45CM	52155-10I	52155-10C1	52155-10C9	52155-10C10	52155-10C17	52155-10C3	52155-10C4
KELLY GRASPER 14MM TIP 	5MM	24CM	52224-11I	52224-11C1	52224-11C9	52224-11C10	52224-11C17	52224-11C3	52224-11C4
	5MM	33CM	52255-11I	52255-11C1	52255-11C9	52255-11C10	52255-11C17	52255-11C3	52255-11C4
	5MM	36CM	52236-11I	52236-11C1	52236-11C9	52236-11C10	52236-11C17	52236-11C3	52236-11C4
	5MM	45CM	52155-11I	52155-11C1	52155-11C9	52155-11C10	52155-11C17	52155-11C3	52155-11C4
RIGHT ANGLE, LONG REACH GRASPER 22MM TIP 	5MM	24CM	52224-53I	52224-53C1	52224-53C9	52224-53C10	52224-53C17	52224-53C3	52224-53C4
	5MM	33CM	52255-53I	52255-53C1	52255-53C9	52255-53C10	52255-53C17	52255-53C3	52255-53C4
	5MM	36CM	52236-53I	52236-53C1	52236-53C9	52236-53C10	52236-53C17	52236-53C3	52236-53C4
	5MM	45CM	52155-53I	52155-53C1	52155-53C9	52155-53C10	52155-53C17	52155-53C3	52155-53C4
PETELIN DISSECTOR, 60° ANGLE, SA 10MM TIP 	5MM	24CM	52224-12I	52224-12C1	52224-12C9	52224-12C10	52224-12C17	52224-12C3	52224-12C4
	5MM	33CM	52255-12I	52255-12C1	52255-12C9	52255-12C10	52255-12C17	52255-12C3	52255-12C4
	5MM	36CM	52236-12I	52236-12C1	52236-12C9	52236-12C10	52236-12C17	52236-12C3	52236-12C4
	5MM	45CM	52155-12I	52155-12C1	52155-12C9	52155-12C10	52155-12C17	52155-12C3	52155-12C4
PETELIN DISSECTOR, 30° ANGLE, SA 10MM TIP 	5MM	24CM	52224-13I	52224-13C1	52224-13C9	52224-13C10	52224-13C17	52224-13C3	52224-13C4
	5MM	33CM	52255-13I	52255-13C1	52255-13C9	52255-13C10	52255-13C17	52255-13C3	52255-13C4
	5MM	36CM	52236-13I	52236-13C1	52236-13C9	52236-13C10	52236-13C17	52236-13C3	52236-13C4
	5MM	45CM	52155-13I	52155-13C1	52155-13C9	52155-13C10	52155-13C17	52155-13C3	52155-13C4
PETELIN STRONG RIGHT ANGLE DISSECTOR 10MM TIP 	5MM	24CM	52224-113I	52224-113C1	52224-113C9	52224-113C10	52224-113C17	52224-113C3	52224-113C4
	5MM	33CM	52255-113I	52255-113C1	52255-113C9	52255-113C10	52255-113C17	52255-113C3	52255-113C4
	5MM	36CM	52236-113I	52236-113C1	52236-113C9	52236-113C10	52236-113C17	52236-113C3	52236-113C4
	5MM	45CM	52155-113I	52155-113C1	52155-113C9	52155-113C10	52155-113C17	52155-113C3	52155-113C4













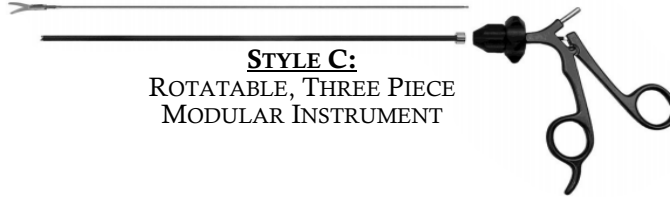



5MM DISSECTORS & GRASPERS

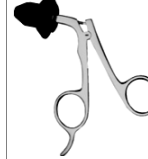

MADE IN THE USA

STYLE C:
ROTATABLE, THREE PIECE
MODULAR INSTRUMENT



TIP ID & LENGTH	HANDLE		INSERT ONLY	TYPE 1	TYPE 9	TYPE 10	TYPE 17	TYPE 3	TYPE 4
	DIAMETER	LENGTH							
				INSULATED HANDLES				NON-INSULATED	
MICRO GRASPER, FENESTRATED 10MM TIP 	5MM	24CM	52224-14I	52224-14C1	52224-14C9	52224-14C10	52224-14C17	52224-14C3	52224-14C4
	5MM	33CM	52255-14I	52255-14C1	52255-14C9	52255-14C10	52255-14C17	52255-14C3	52255-14C4
	5MM	36CM	52236-14I	52236-14C1	52236-14C9	52236-14C10	52236-14C17	52236-14C3	52236-14C4
	5MM	45CM	52155-14I	52155-14C1	52155-14C9	52155-14C10	52155-14C17	52155-14C3	52155-14C4
COBRA GRASPER, DBL-ACTION 10MM TIP 	5MM	24CM	52224-15I	52224-15C1	52224-15C9	52224-15C10	52224-15C17	52224-15C3	52224-15C4
	5MM	33CM	52255-15I	52255-15C1	52255-15C9	52255-15C10	52255-15C17	52255-15C3	52255-15C4
	5MM	36CM	52236-15I	52236-15C1	52236-15C9	52236-15C10	52236-15C17	52236-15C3	52236-15C4
	5MM	45CM	52155-15I	52155-15C1	52155-15C9	52155-15C10	52155-15C17	52155-15C3	52155-15C4
BABCOCK GRASPER, FENESTRATED TIP 30MM TIP 	5MM	24CM	52224-16I	52224-16C1	52224-16C9	52224-16C10	52224-16C17	52224-16C3	52224-16C4
	5MM	33CM	52255-16I	52255-16C1	52255-16C9	52255-16C10	52255-16C17	52255-16C3	52255-16C4
	5MM	36CM	52236-16I	52236-16C1	52236-16C9	52236-16C10	52236-16C17	52236-16C3	52236-16C4
	5MM	45CM	52155-16I	52155-16C1	52155-16C9	52155-16C10	52155-16C17	52155-16C3	52155-16C4
BABCOCK, AXIS STYLE, FENESTRATED 30MM TIP 	5MM	24CM	52224-116I	52224-116C1	52224-116C9	52224-116C10	52224-116C17	52224-116C3	52224-116C4
	5MM	33CM	52255-116I	52255-116C1	52255-116C9	52255-116C10	52255-116C17	52255-116C3	52255-116C4
	5MM	36CM	52236-116I	52236-116C1	52236-116C9	52236-116C10	52236-116C17	52236-116C3	52236-116C4
	5MM	45CM	52155-116I	52155-116C1	52155-116C9	52155-116C10	52155-116C17	52155-116C3	52155-116C4
PADDLE BABCOCK GRASPER 30MM TIP 	5MM	24CM	52224-216I	52224-216C1	52224-216C9	52224-216C10	52224-216C17	52224-216C3	52224-216C4
	5MM	33CM	52255-216I	52255-216C1	52255-216C9	52255-216C10	52255-216C17	52255-216C3	52255-216C4
	5MM	36CM	52236-216I	52236-216C1	52236-216C9	52236-216C10	52236-216C17	52236-216C3	52236-216C4
	5MM	45CM	52155-216I	52155-216C1	52155-216C9	52155-216C10	52155-216C17	52155-216C3	52155-216C4
BABCOCK GRASPER, SHORT DELICATE 20MM TIP 	5MM	24CM	52224-17I	52224-17C1	52224-17C9	52224-17C10	52224-17C17	52224-17C3	52224-17C4
	5MM	33CM	52255-17I	52255-17C1	52255-17C9	52255-17C10	52255-17C17	52255-17C3	52255-17C4
	5MM	36CM	52236-17I	52236-17C1	52236-17C9	52236-17C10	52236-17C17	52236-17C3	52236-17C4
	5MM	45CM	52155-17I	52155-17C1	52155-17C9	52155-17C10	52155-17C17	52155-17C3	52155-17C4
ALLIS GRASPER, SHORT VERSION, SA 15MM TIP 	5MM	24CM	52224-18I	52224-18C1	52224-18C9	52224-18C10	52224-18C17	52224-18C3	52224-18C4
	5MM	33CM	52255-18I	52255-18C1	52255-18C9	52255-18C10	52255-18C17	52255-18C3	52255-18C4
	5MM	36CM	52236-18I	52236-18C1	52236-18C9	52236-18C10	52236-18C17	52236-18C3	52236-18C4
	5MM	45CM	52155-18I	52155-18C1	52155-18C9	52155-18C10	52155-18C17	52155-18C3	52155-18C4











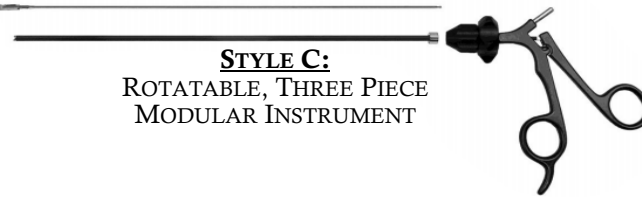





5MM DISSECTORS & GRASPERS

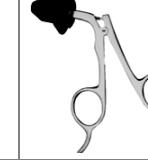
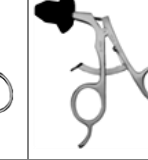

MADE IN THE USA



STYLE C:
ROTATABLE, THREE PIECE
MODULAR INSTRUMENT

TIP ID & LENGTH	HANDLE		INSERT ONLY	TYPE 1	TYPE 9	TYPE 10	TYPE 17	TYPE 3	TYPE 4
	DIAMETER	LENGTH							
				INSULATED HANDLES				NON-INSULATED	
ALLIS, SHORT VERSION, 3X4 TEETH, SERRATED 12MM TIP 	5MM	24CM	52224-19I	52224-19C1	52224-19C9	52224-19C10	52224-19C17	52224-19C3	52224-19C4
	5MM	33CM	52255-19I	52255-19C1	52255-19C9	52255-19C10	52255-19C17	52255-19C3	52255-19C4
	5MM	36CM	52236-19I	52236-19C1	52236-19C9	52236-19C10	52236-19C17	52236-19C3	52236-19C4
	5MM	45CM	52155-19I	52155-19C1	52155-19C9	52155-19C10	52155-19C17	52155-19C3	52155-19C4
ALLIS, SHORT VERSION, DBL ROW OF TEETH, SERRATED 12MM TIP 	5MM	24CM	52224-119I	52224-119C1	52224-119C9	52224-119C10	52224-119C17	52224-119C3	52224-119C4
	5MM	33CM	52255-119I	52255-119C1	52255-119C9	52255-119C10	52255-119C17	52255-119C3	52255-119C4
	5MM	36CM	52236-119I	52236-119C1	52236-119C9	52236-119C10	52236-119C17	52236-119C3	52236-119C4
	5MM	45CM	52155-119I	52155-119C1	52155-119C9	52155-119C10	52155-119C17	52155-119C3	52155-119C4
ALLIS, LONG VERSION, DBL ROW OF TEETH, SERRATED 25MM TIP 	5MM	24CM	52224-219I	52224-219C1	52224-219C9	52224-219C10	52224-219C17	52224-219C3	52224-219C4
	5MM	33CM	52255-219I	52255-219C1	52255-219C9	52255-219C10	52255-219C17	52255-219C3	52255-219C4
	5MM	36CM	52236-219I	52236-219C1	52236-219C9	52236-219C10	52236-219C17	52236-219C3	52236-219C4
	5MM	45CM	52155-219I	52155-219C1	52155-219C9	52155-219C10	52155-219C17	52155-219C3	52155-219C4
ALLIS GRASPER, MEDIUM, WECK STYLE 20MM TIP 	5MM	24CM	52224-20I	52224-20C1	52224-20C9	52224-20C10	52224-20C17	52224-20C3	52224-20C4
	5MM	33CM	52255-20I	52255-20C1	52255-20C9	52255-20C10	52255-20C17	52255-20C3	52255-20C4
	5MM	36CM	52236-20I	52236-20C1	52236-20C9	52236-20C10	52236-20C17	52236-20C3	52236-20C4
	5MM	45CM	52155-20I	52155-20C1	52155-20C9	52155-20C10	52155-20C17	52155-20C3	52155-20C4
ALLIS GRASPER STD. VERSION 30MM TIP 	5MM	24CM	52224-21I	52224-21C1	52224-21C9	52224-21C10	52224-21C17	52224-21C3	52224-21C4
	5MM	33CM	52255-21I	52255-21C1	52255-21C9	52255-21C10	52255-21C17	52255-21C3	52255-21C4
	5MM	36CM	52236-21I	52236-21C1	52236-21C9	52236-21C10	52236-21C17	52236-21C3	52236-21C4
	5MM	45CM	52155-21I	52155-21C1	52155-21C9	52155-21C10	52155-21C17	52155-21C3	52155-21C4
ALLIS GRASPER, TC, STD. VERSION 35MM TIP 	5MM	24CM	52224-57I	52224-57C1	52224-57C9	52224-57C10	52224-57C17	52224-57C3	52224-57C4
	5MM	33CM	52255-57I	52255-57C1	52255-57C9	52255-57C10	52255-57C17	52255-57C3	52255-57C4
	5MM	36CM	52236-57I	52236-57C1	52236-57C9	52236-57C10	52236-57C17	52236-57C3	52236-57C4
	5MM	45CM	52155-57I	52155-57C1	52155-57C9	52155-57C10	52155-57C17	52155-57C3	52155-57C4
DEBAKEY GRASPER 20MM TIP 	5MM	24CM	52224-22I	52224-22C1	52224-22C9	52224-22C10	52224-22C17	52224-22C3	52224-22C4
	5MM	33CM	52255-22I	52255-22C1	52255-22C9	52255-22C10	52255-22C17	52255-22C3	52255-22C4
	5MM	36CM	52236-22I	52236-22C1	52236-22C9	52236-22C10	52236-22C17	52236-22C3	52236-22C4
	5MM	45CM	52155-22I	52155-22C1	52155-22C9	52155-22C10	52155-22C17	52155-22C3	52155-22C4













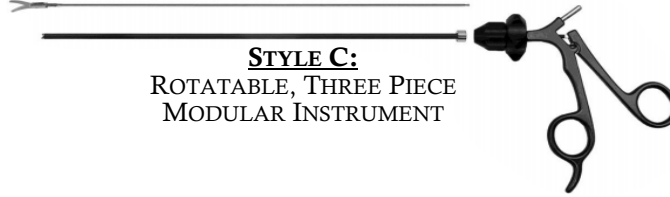





5MM DISSECTORS & GRASPERS



MADE IN THE USA

STYLE C:
ROTATABLE, THREE PIECE
MODULAR INSTRUMENT



TIP ID & LENGTH	HANDLE		INSERT ONLY	TYPE 1	TYPE 9	TYPE 10	TYPE 17	TYPE 3	TYPE 4
	DIAMETER	LENGTH							
				INSULATED HANDLES				NON-INSULATED	
DEBAKEY GRASPER 34MM TIP 	5MM	24CM	52224-222I	52224-222C1	52224-222C9	52224-222C10	52224-222C17	52224-222C3	52224-222C4
	5MM	33CM	52255-222I	52255-222C1	52255-222C9	52255-222C10	52255-222C17	52255-222C3	52255-222C4
	5MM	36CM	52236-222I	52236-222C1	52236-222C9	52236-222C10	52236-222C17	52236-222C3	52236-222C4
	5MM	45CM	52155-222I	52155-222C1	52155-222C9	52155-222C10	52155-222C17	52155-222C3	52155-222C4
DEBAKEY GRASPER 40MM TIP 	5MM	24CM	52224-23I	52224-23C1	52224-23C9	52224-23C10	52224-23C17	52224-23C3	52224-23C4
	5MM	33CM	52255-23I	52255-23C1	52255-23C9	52255-23C10	52255-23C17	52255-23C3	52255-23C4
	5MM	36CM	52236-23I	52236-23C1	52236-23C9	52236-23C10	52236-23C17	52236-23C3	52236-23C4
	5MM	45CM	52155-23I	52155-23C1	52155-23C9	52155-23C10	52155-23C17	52155-23C3	52155-23A4
DEBAKEY GRASPER 60MM TIP 	5MM	24CM	52224-160I	52224-160C1	52224-160C9	52224-160C10	52224-160C17	52224-160C3	52224-160C4
	5MM	33CM	52255-160I	52255-160C1	52255-160C9	52255-160C10	52255-160C17	52255-160C3	52255-160C4
	5MM	36CM	52236-160I	52236-160C1	52236-160C9	52236-160C10	52236-160C17	52236-160C3	52236-160C4
	5MM	45CM	52155-160I	52155-160C1	52155-160C9	52155-160C10	52155-160C17	52155-160C3	52155-160C4
HUNTER DEBAKEY, FENESTRATED 16MM TIP 	5MM	24CM	52224-158I	52224-158C1	52224-158C9	52224-158C10	52224-158C17	52224-158C3	52224-158C4
	5MM	33CM	52255-158I	52255-158C1	52255-158C9	52255-158C10	52255-158C17	52255-158C3	52255-158C4
	5MM	36CM	52236-158I	52236-158C1	52236-158C9	52236-158C10	52236-158C17	52236-158C3	52236-158C4
	5MM	45CM	52155-158I	52155-158C1	52155-158C9	52155-158C10	52155-158C17	52155-158C3	52155-158C4
HUNTER DEBAKEY, FENESTRATED 20MM TIP 	5MM	24CM	52224-58I	52224-58C1	52224-58C9	52224-58C10	52224-58C17	52224-58C3	52224-58C4
	5MM	33CM	52255-58I	52255-58C1	52255-58C9	52255-58C10	52255-58C17	52255-58C3	52255-58C4
	5MM	36CM	52236-58I	52236-58C1	52236-58C9	52236-58C10	52236-58C17	52236-58C3	52236-58C4
	5MM	45CM	52155-58I	52155-58C1	52155-58C9	52155-58C10	52155-58C17	52155-58C3	52155-58C4
HUNTER DEBAKEY, FENESTRATED 40MM TIP 	5MM	24CM	52224-159I	52224-159C1	52224-159C9	52224-159C10	52224-159C17	52224-159C3	52224-159C4
	5MM	33CM	52255-159I	52255-159C1	52255-159C9	52255-159C10	52255-159C17	52255-159C3	52255-159C4
	5MM	36CM	52236-159I	52236-159C1	52236-159C9	52236-159C10	52236-159C17	52236-159C3	52236-159C4
	5MM	45CM	52155-159I	52155-159C1	52155-159C9	52155-159C10	52155-159C17	52155-159C3	52155-159C4
HUNTER DEBAKEY, FENESTRATED 60MM TIP 	5MM	24CM	52224-160I	52224-160C1	52224-160C9	52224-160C10	52224-160C17	52224-160C3	52224-160C4
	5MM	33CM	52255-160I	52255-160C1	52255-160C9	52255-160C10	52255-160C17	52255-160C3	52255-160C4
	5MM	36CM	52236-160I	52236-160C1	52236-160C9	52236-160C10	52236-160C17	52236-160C3	52236-160C4
	5MM	45CM	52155-160I	52155-160C1	52155-160C9	52155-160C10	52155-160C17	52155-160C3	52155-160C4











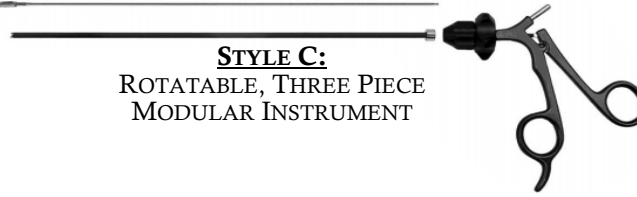





5MM DISSECTORS & GRASPERS

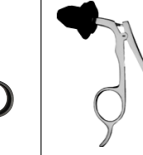
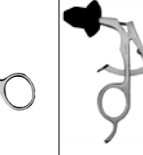

MADE IN THE USA



STYLE C:
ROTATABLE, THREE PIECE
MODULAR INSTRUMENT

TIP ID & LENGTH	HANDLE		INSERT ONLY	TYPE 1	TYPE 9	TYPE 10	TYPE 17	TYPE 3	TYPE 4
	DIAMETER	LENGTH							
				INSULATED HANDLES				NON-INSULATED	
DEBAKEY GRASPER, CURVED 30MM TIP 	5MM	24CM	52224-46I	52224-46C1	52224-46C9	52224-46C10	52224-46C17	52224-46C3	52224-46C4
	5MM	33CM	52255-46I	52255-46C1	52255-46C9	52255-46C10	52255-46C17	52255-46C3	52255-46C4
	5MM	36CM	52236-46I	52236-46C1	52236-46C9	52236-46C10	52236-46C17	52236-46C3	52236-46C4
	5MM	45CM	52155-46I	52155-46C1	52155-46C9	52155-46C10	52155-46C17	52155-46C3	52155-46C4
DEBAKEY MARYLAND GRASPER 35MM TIP 	5MM	24CM	52224-149I	52224-149C1	52224-149C9	52224-149C10	52224-149C17	52224-149C3	52224-149C4
	5MM	33CM	52255-149I	52255-149C1	52255-149C9	52255-149C10	52255-149C17	52255-149C3	52255-149C4
	5MM	36CM	52236-149I	52236-149C1	52236-149C9	52236-149C10	52236-149C17	52236-149C3	52236-149C4
	5MM	45CM	52155-149I	52155-149C1	52155-149C9	52155-149C10	52155-149C17	52155-149C3	52155-149C4
GLASSMAN ATRAUMATIC GRASPER 30MM TIP 	5MM	24CM	52224-24I	52224-24C1	52224-24C9	52224-24C10	52224-24C17	52224-24C3	52224-24C4
	5MM	33CM	52255-24I	52255-24C1	52255-24C9	52255-24C10	52255-24C17	52255-24C3	52255-24C4
	5MM	36CM	52236-24I	52236-24C1	52236-24C9	52236-24C10	52236-24C17	52236-24C3	52236-24C4
	5MM	45CM	52155-24I	52155-24C1	52155-24C9	52155-24C10	52155-24C17	52155-24C3	52155-24C4
GRASPER, CROSS SERRATED, SA 10MM TIP 	5MM	24CM	52224-25I	52224-25C1	52224-25C9	52224-25C10	52224-25C17	52224-25C3	52224-25C4
	5MM	33CM	52255-25I	52255-25C1	52255-25C9	52255-25C10	52255-25C17	52255-25C3	52255-25C4
	5MM	36CM	52236-25I	52236-25C1	52236-25C9	52236-25C10	52236-25C17	52236-25C3	52236-25C4
	5MM	45CM	52155-25I	52155-25C1	52155-25C9	52155-25C10	52155-25C17	52155-25C3	52155-25C4
DOUBLE CUP FUNDUS MAXI GRASPER 16MM TIP 	5MM	24CM	52224-26I	52224-26C1	52224-26C9	52224-26C10	52224-26C17	52224-26C3	52224-26C4
	5MM	33CM	52255-26I	52255-26C1	52255-26C9	52255-26C10	52255-26C17	52255-26C3	52255-26C4
	5MM	36CM	52236-26I	52236-26C1	52236-26C9	52236-26C10	52236-26C17	52236-26C3	52236-26C4
	5MM	45CM	52155-26I	52155-26C1	52155-26C9	52155-26C10	52155-26C17	52155-26C3	52155-26C4
FENESTRATED DOUBLE FUNDUS GRASPER 16MM TIP 	5MM	24CM	52224-226I	52224-226C1	52224-226C9	52224-226C10	52224-226C17	52224-226C3	52224-226C4
	5MM	33CM	52255-226I	52255-226C1	52255-226C9	52255-226C10	52255-226C17	52255-226C3	52255-226C4
	5MM	36CM	52236-226I	52236-226C1	52236-226C9	52236-226C10	52236-226C17	52236-226C3	52236-226C4
	5MM	45CM	52155-22I	52155-226C1	52155-226C9	52155-226C10	52155-226C17	52155-226C3	52155-226C4
"MCKEARNAN" STYLE FUNDUS GRASPER 16MM TIP 	5MM	24CM	52224-126I	52224-126C1	52224-126C9	52224-126C10	52224-126C17	52224-126C3	52224-126C4
	5MM	33CM	52255-126I	52255-126C1	52255-126C9	52255-126C10	52255-126C17	52255-126C3	52255-126C4
	5MM	36CM	52236-126I	52236-126C1	52236-126C9	52236-126C10	52236-126C17	52236-126C3	52236-126C4
	5MM	45CM	52155-126I	52155-126C1	52155-126C9	52155-126C10	52155-126C17	52155-126C3	52155-126C4











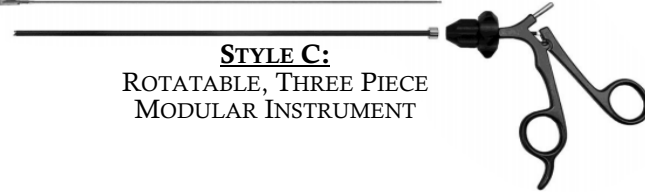





5MM DISSECTORS & GRASPERS

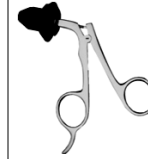
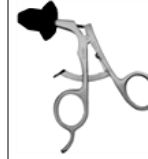

MADE IN THE USA



STYLE C:
ROTATABLE, THREE PIECE
MODULAR INSTRUMENT

TIP ID & LENGTH	HANDLE		INSERT ONLY	TYPE 1	TYPE 9	TYPE 10	TYPE 17	TYPE 3	TYPE 4
	DIAMETER	LENGTH							
				INSULATED HANDLES				NON-INSULATED	
"WINER" STYLE FUNDUS GRASPER 16MM TIP 	5MM	24CM	52224-326I	52224-326C1	52224-326C9	52224-326C10	52224-326C17	52224-326C3	52224-326C4
	5MM	33CM	52255-326I	52255-326C1	52255-326C9	52255-326C10	52255-326C17	52255-326C3	52255-326C4
	5MM	36CM	52236-326I	52236-326C1	52236-326C9	52236-326C10	52236-326C17	52236-326C3	52236-326C4
	5MM	45CM	52155-326I	52155-326C1	52155-326C9	52155-326C10	52155-326C17	52155-326C3	52155-326C4
"JARIT" STYLE GRASPING FORCEPS DUAL CUP 16MM TIP 	5MM	24CM	52224-426I	52224-426C1	52224-426C9	52224-426C10	52224-426C17	52224-426C3	52224-426C4
	5MM	33CM	52255-426I	52255-426C1	52255-426C9	52255-426C10	52255-426C17	52255-426C3	52255-426C4
	5MM	36CM	52236-426I	52236-426C1	52236-426C9	52236-426C10	52236-426C17	52236-426C3	52236-426C4
	5MM	45CM	52155-426I	52155-426C1	52155-426C9	52155-426C10	52155-426C17	52155-426C3	52155-426C4
ENDOCLINCH FENESTRATED GRASPER 20MM TIP 	5MM	24CM	52224-27I	52224-27C1	52224-27C9	52224-27C10	52224-27C17	52224-27C3	52224-27C4
	5MM	33CM	52255-27I	52255-27C1	52255-27C9	52255-27C10	52255-27C17	52255-27C3	52255-27C4
	5MM	36CM	52236-27I	52236-27C1	52236-27C9	52236-27C10	52236-27C17	52236-27C3	52236-27C4
	5MM	45CM	52155-27I	52155-27C1	52155-27C9	52155-27C10	52155-27C17	52155-27C3	52155-27C4
RETRO-FACING, RAT TOOTH W/ CUP 10MM TIP 	5MM	24CM	52224-28I	52224-28C1	52224-28C9	52224-28C10	52224-28C17	52224-28C3	52224-28C4
	5MM	33CM	52255-28I	52255-28C1	52255-28C9	52255-28C10	52255-28C17	52255-28C3	52255-28C4
	5MM	36CM	52236-28I	52236-28C1	52236-28C9	52236-28C10	52236-28C17	52236-28C3	52236-28C4
	5MM	45CM	52155-28I	52155-28C1	52155-28C9	52155-28C10	52155-28C17	52155-28C3	52155-28C4
ALLIGATOR GRASPER, RETRO- FACING TEETH DA 10MM TIP 	5MM	24CM	52224-29I	52224-29C1	52224-29C9	52224-29C10	52224-29C17	52224-29C3	52224-29C4
	5MM	33CM	52255-29I	52255-29C1	52255-29C9	52255-29C10	52255-29C17	52255-29C3	52255-29C4
	5MM	36CM	52236-29I	52236-29C1	52236-29C9	52236-29C10	52236-29C17	52236-29C3	52236-29C4
	5MM	45CM	52155-29I	52155-29C1	52155-29C9	52155-29C10	52155-29C17	52155-29C3	52155-29C4
ALLIGATOR GRASPER, RETRO- FACING TEETH, DA 20MM TIP 	5MM	24CM	52224-129I	52224-129C1	52224-129C9	52224-129C10	52224-129C17	52224-129C3	52224-129C4
	5MM	33CM	52255-129I	52255-129C1	52255-129C9	52255-129C10	52255-129C17	52255-129C3	52255-129C4
	5MM	36CM	52236-129I	52236-129C1	52236-129C9	52236-129C10	52236-129C17	52236-129C3	52236-129C4
	5MM	45CM	52155-129I	52155-129C1	52155-129C9	52155-129C10	52155-129C17	52155-129C3	52155-129C4
ALLIGATOR GRASPER, RETRO- FACING TEETH, SA 10MM TIP 	5MM	24CM	52224-30I	52224-30C1	52224-30C9	52224-30C10	52224-30C17	52224-30C3	52224-30C4
	5MM	33CM	52255-30I	52255-30C1	52255-30C9	52255-30C10	52255-30C17	52255-30C3	52255-30C4
	5MM	36CM	52236-30I	52236-30C1	52236-30C9	52236-30C10	52236-30C17	52236-30C3	52236-30C4
	5MM	45CM	52155-30I	52155-30C1	52155-30C9	52155-30C10	52155-30C17	52155-30C3	52155-30C4











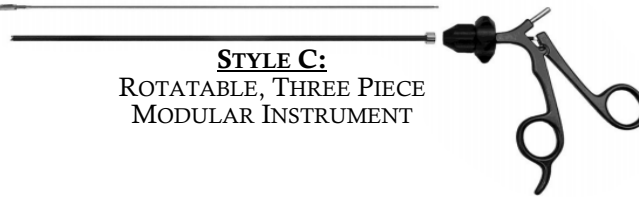





5MM DISSECTORS & GRASPERS

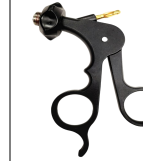
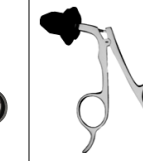
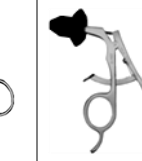

MADE IN THE USA



STYLE C:
ROTATABLE, THREE PIECE
MODULAR INSTRUMENT

TIP ID & LENGTH	HANDLE		INSERT ONLY	TYPE 1	TYPE 9	TYPE 10	TYPE 17	TYPE 3	TYPE 4
	DIAMETER	LENGTH							
				INSULATED HANDLES				NON-INSULATED	
CUP SHAED GRASPER, W/ RETRO-FACING TEETH 10MM TIP 	5MM	24CM	52224-31I	52224-31C1	52224-31C9	52224-31C10	52224-31C17	52224-31C3	52224-31C4
	5MM	33CM	52255-31I	52255-31C1	52255-31C9	52255-31C10	52255-31C17	52255-31C3	52255-31C4
	5MM	36CM	52236-31I	52236-31C1	52236-31C9	52236-31C10	52236-31C17	52236-31C3	52236-31C4
	5MM	45CM	52155-31I	52155-31C1	52155-31C9	52155-31C10	52155-31C17	52155-31C3	52155-31C4
WAVE GRASPER, LONG BEVELED EDGE, DA 22MM TIP 	5MM	24CM	52224-32I	52224-32C1	52224-32C9	52224-32C10	52224-32C17	52224-32C3	52224-32C4
	5MM	33CM	52255-32I	52255-32C1	52255-32C9	52255-32C10	52255-32C17	52255-32C3	52255-32C4
	5MM	36CM	52236-32I	52236-32C1	52236-32C9	52236-32C10	52236-32C17	52236-32C3	52236-32C4
	5MM	45CM	52155-32I	52155-32C1	52155-32C9	52155-32C10	52155-32C17	52155-32C3	52155-32C4
WAVE GRASPER, LONG BEVELED EDGE, SA 22MM TIP 	5MM	24CM	52224-33I	52224-33C1	52224-33C9	52224-33C10	52224-33C17	52224-33C3	52224-33C4
	5MM	33CM	52255-33I	52255-33C1	52255-33C9	52255-33C10	52255-33C17	52255-33C3	52255-33C4
	5MM	36CM	52236-33I	52236-33C1	52236-33C9	52236-33C10	52236-33C17	52236-33C3	52236-33C4
	5MM	45CM	52155-33I	52155-33C1	52155-33C9	52155-33C10	52155-33C17	52155-33C3	52155-33C4
RETRACTION GRASPER, 2 X 3 TEETH, COBRA STYLE, DA 20MM TIP 	5MM	24CM	52224-34I	52224-34C1	52224-34C9	52224-34C10	52224-34C17	52224-34C3	52224-34C4
	5MM	33CM	52255-34I	52255-34C1	52255-34C9	52255-34C10	52255-34C17	52255-34C3	52255-34C4
	5MM	36CM	52236-34I	52236-34C1	52236-34C9	52236-34C10	52236-34C17	52236-34C3	52236-34C4
	5MM	45CM	52155-34I	52155-34C1	52155-34C9	52155-34C10	52155-34C17	52155-34C3	52155-34C4
RETRACTION GRASPER, 2 X 3 TEETH, COBRA STYLE, SA 20MM TIP 	5MM	24CM	52224-35I	52224-35C1	52224-35C9	52224-35C10	52224-35C17	52224-35C3	52224-35C4
	5MM	33CM	52255-35I	52255-35C1	52255-35C9	52255-35C10	52255-35C17	52255-35C3	52255-35C4
	5MM	36CM	52236-35I	52236-35C1	52236-35C9	52236-35C10	52236-35C17	52236-35C3	52236-35C4
	5MM	45CM	52155-35I	52155-35C1	52155-35C9	52155-35C10	52155-35C17	52155-35C3	52155-35C4
RETRACTION GRASPER, 2 X 3 TEETH, JARIT STYLE, DA 20MM TIP 	5MM	24CM	52224-134I	52224-134C1	52224-134C9	52224-134C10	52224-134C17	52224-134C3	52224-134C4
	5MM	33CM	52255-134I	52255-134C1	52255-134C9	52255-134C10	52255-134C17	52255-134C3	52255-134C4
	5MM	36CM	52236-134I	52236-134C1	52236-134C9	52236-134C10	52236-134C17	52236-134C3	52236-134C4
	5MM	45CM	52155-134II	52155-134C1	52155-134C9	52155-134C10	52155-134C17	52155-134C3	52155-134C4
RETRACTION GRASPER, 2 X 3 TEETH, JARIT STYLE, SA 20MM TIP 	5MM	24CM	52224-135I	52224-135C1	52224-135C9	52224-135C10	52224-135C17	52224-135C3	52224-135C4
	5MM	33CM	52255-135I	52255-135C1	52255-135C9	52255-135C10	52255-135C17	52255-135C3	52255-135C4
	5MM	36CM	52236-135I	52236-135C1	52236-135C9	52236-135C10	52236-135C17	52236-135C3	52236-135C4
	5MM	45CM	52155-135I	52155-135C1	52155-135C9	52155-135C10	52155-135C17	52155-135C3	52155-135C4











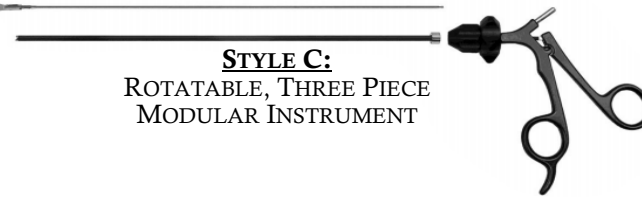





5MM DISSECTORS & GRASPERS

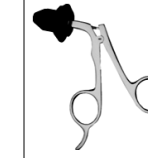
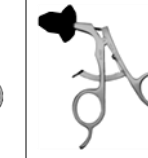

MADE IN THE USA



STYLE C:
ROTATABLE, THREE PIECE
MODULAR INSTRUMENT

TIP ID & LENGTH	HANDLE		INSERT ONLY	TYPE 1	TYPE 9	TYPE 10	TYPE 17	TYPE 3	TYPE 4
	DIA.	LENGTH							
				INSULATED HANDLES				NON-INSULATED	
 CLAW GRASPER, 2 X 3 TEETH, SA 20MM TIP	5MM	24CM	52224-36I	52224-36C1	52224-36C9	52224-36C10	52224-36C17	52224-36C3	52224-36C4
	5MM	33CM	52255-36I	52255-36C1	52255-36C9	52255-36C10	52255-36C17	52255-36C3	52255-36C4
	5MM	36CM	52236-36I	52236-36C1	52236-36C9	52236-36C10	52236-36C17	52236-36C3	52236-36C4
	5MM	45CM	52155-36I	52155-36C1	52155-36C9	52155-36C10	52155-36C17	52155-36C3	52155-36C4
 CLAW GRASPER, 2 X 3 TEETH, W/ XTRA ROW OF TEETH 20MM TIP	5MM	24CM	52224-136I	52224-136C1	52224-136C9	52224-136C10	52224-136C17	52224-136C3	52224-136C4
	5MM	33CM	52255-136I	52255-136C1	52255-136C9	52255-136C10	52255-136C17	52255-136C3	52255-136C4
	5MM	36CM	52236-136I	52236-136C1	52236-136C9	52236-136C10	52236-136C17	52236-136C3	52236-136C4
	5MM	45CM	52155-136I	52155-136C1	52155-136C9	52155-136C10	52155-136C17	52155-136C3	52155-136C4
 ATRAUMATIC FENESTRATED GRASPER, CURVED 16MM TIP	5MM	24CM	52224-37I	52224-37C1	52224-37C9	52224-37C10	52224-37C17	52224-37C3	52224-37C4
	5MM	33CM	52255-37I	52255-37C1	52255-37C9	52255-37C10	52255-37C17	52255-37C3	52255-37C4
	5MM	36CM	52236-37I	52236-37C1	52236-37C9	52236-37C10	52236-37C17	52236-37C3	52236-37C4
	5MM	45CM	52155-37I	52155-37C1	52155-37C9	52155-37C10	52155-37C17	52155-37C3	52155-37C4
 FENESTRATED GRASPER 16MM TIP	5MM	24CM	52224-38I	52224-38C1	52224-38C9	52224-38C10	52224-38C17	52224-38C3	52224-38C4
	5MM	33CM	52255-38I	52255-38C1	52255-38C9	52255-38C10	52255-38C17	52255-38C3	52255-38C4
	5MM	36CM	52236-38I	52236-38C1	52236-38C9	52236-38C10	52236-38C17	52236-38C3	52236-38C4
	5MM	45CM	52155-38I	52155-38C1	52155-38C9	52155-38C10	52155-38C17	52155-38C3	52155-38C4
 FENESTRATED GRASPER 20MM TIP	5MM	24CM	52224-39I	52224-39C1	52224-39C9	52224-39C10	52224-39C17	52224-39C3	52224-39C4
	5MM	33CM	52255-39I	52255-39C1	52255-39C9	52255-39C10	52255-39C17	52255-39C3	52255-39C4
	5MM	36CM	52236-39I	52236-39C1	52236-39C9	52236-39C10	52236-39C17	52236-39C3	52236-39C4
	5MM	45CM	52155-39I	52155-39C1	52155-39C9	52155-39C10	52155-39C17	52155-39C3	52155-39C4
 FENESTRATED GRASPER 40MM TIP	5MM	24CM	52224-40I	52224-40C1	52224-40C9	52224-40C10	52224-40C17	52224-40C3	52224-40C4
	5MM	33CM	52255-40I	52255-40C1	52255-40C9	52255-40C10	52255-40C17	52255-40C3	52255-40C4
	5MM	36CM	52236-40I	52236-40C1	52236-40C9	52236-40C10	52236-40C17	52236-40C3	52236-40C4
	5MM	45CM	52155-40I	52155-40C1	52155-40C9	52155-40C10	52155-40C17	52155-40C3	52155-40C4
 JOHAN FENESTRATED GRASPER, SA 20MM TIP	5MM	24CM	52224-41I	52224-41C1	52224-41C9	52224-41C10	52224-41C17	52224-41C3	52224-41C4
	5MM	33CM	52255-41I	52255-41C1	52255-41C9	52255-41C10	52255-41C17	52255-41C3	52255-41C4
	5MM	36CM	52236-41I	52236-41C1	52236-41C9	52236-41C10	52236-41C17	52236-41C3	52236-41C4
	5MM	45CM	52155-41I	52155-41C1	52155-41C9	52155-41C10	52155-41C17	52155-41C3	52155-41C4











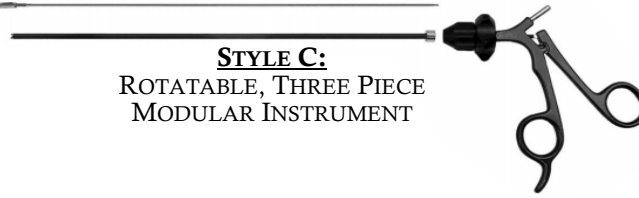





5MM DISSECTORS & GRASPERS



MADE IN THE USA

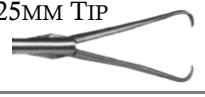

TIP ID & LENGTH	HANDLE		INSERT ONLY	TYPE 1	TYPE 9	TYPE 10	TYPE 17	TYPE 3	TYPE 4
	DIAMETER	LENGTH							
				INSULATED HANDLES				NON-INSULATED	
JOHAN FENESTRATED GRASPER, 45MM TIP, SA 45MM TIP 	5MM	24CM	52224-42I	52224-42C1	52224-42C9	52224-42C10	52224-42C17	52224-42C3	52224-42C4
	5MM	33CM	52255-42I	52255-42C1	52255-42C9	52255-42C10	52255-42C17	52255-42C3	52255-42C4
	5MM	36CM	52236-42I	52236-42C1	52236-42C9	52236-42C10	52236-42C17	52236-42C3	52236-42C4
	5MM	45CM	52155-42I	52155-42C1	52155-42C9	52155-42C10	52155-42C17	52155-42C3	52155-42C4
DOUBLE FENESTRATED GRASPER 25MM TIP 	5MM	24CM	52224-139I	52224-139C1	52224-139C9	52224-139C10	52224-139C17	52224-139C3	52224-139C4
	5MM	33CM	52255-139I	52255-139C1	52255-139C9	52255-139C10	52255-139C17	52255-139C3	52255-139C4
	5MM	36CM	52236-139I	52236-139C1	52236-139C9	52236-139C10	52236-139C17	52236-139C3	52236-139C4
	5MM	45CM	52155-139I	52155-139C1	52155-139C9	52155-139C10	52155-139C17	52155-139C3	52155-139C4
KOCHER GRASPER, 1 X 2 TEETH, SA 15MM TIP 	5MM	24CM	52224-43I	52224-43C1	52224-43C9	52224-43C10	52224-43C17	52224-43C3	52224-43C4
	5MM	33CM	52255-43I	52255-43C1	52255-43C9	52255-43C10	52255-43C17	52255-43C3	52255-43C4
	5MM	36CM	52236-43I	52236-43C1	52236-43C9	52236-43C10	52236-43C17	52236-43C3	52236-43C4
	5MM	45CM	52155-43I	52155-43C1	52155-43C9	52155-43C10	52155-43C17	52155-43C3	52155-43C4
KOCHER GRASPER, 1 X 2 TEETH, DA (WECK TYPE) 15MM TIP 	5MM	24CM	52224-44I	52224-44C1	52224-44C9	52224-44C10	52224-44C17	52224-44C3	52224-44C4
	5MM	33CM	52255-44I	52255-44C1	52255-44C9	52255-44C10	52255-44C17	52255-44C3	52255-44C4
	5MM	36CM	52236-44I	52236-44C1	52236-44C9	52236-44C10	52236-44C17	52236-44C3	52236-44C4
	5MM	45CM	52155-44I	52155-44C1	52155-44C9	52155-44C10	52155-44C17	52155-44C3	52155-44C4
SCHROEDER TENACULUM, SINGLE TOOTH, ROUND TIP 25MM TIP 	5MM	24CM	52224-45I	52224-45C1	52224-45C9	52224-45C10	52224-45C17	52224-45C3	52224-45C4
	5MM	33CM	52255-45I	52255-45C1	52255-45C9	52255-45C10	52255-45C17	52255-45C3	52255-45C4
	5MM	36CM	52236-45I	52236-45C1	52236-45C9	52236-45C10	52236-45C17	52236-45C3	52236-45C4
	5MM	45CM	52155-45I	52155-45C1	52155-45C9	52155-45C10	52155-45C17	52155-45C3	52155-45C4
SCHROEDER TENACULUM, SINGLE TOOTH SQUARE TIP 25MM TIP 	5MM	24CM	52224-245I	52224-245C1	52224-245C9	52224-245C10	52224-245C17	52224-245C3	52224-245C4
	5MM	33CM	52255-245I	52255-245C1	52255-245C9	52255-245C10	52255-245C17	52255-245C3	52255-245C4
	5MM	36CM	52236-245I	52236-245C1	52236-245C9	52236-245C10	52236-245C17	52236-245C3	52236-245C4
	5MM	45CM	52155-245I	52155-245C1	52155-245C9	52155-245C10	52155-245C17	52155-245C3	52155-245C4
SCHROEDER TEN. GRASPER, SINGLE TOOTH, XTRA TOOTH 25MM TIP 	5MM	24CM	52224-94I	52224-94C1	52224-94C9	52224-94C10	52224-94C17	52224-94C3	52224-94C4
	5MM	33CM	52255-94I	52255-94C1	52255-94C9	52255-94C10	52255-94C17	52255-94C3	52255-94C4
	5MM	36CM	52236-94I	52236-94C1	52236-94C9	52236-94C10	52236-94C17	52236-94C3	52236-94C4
	5MM	45CM	52155-94I	52155-94C1	52155-94C9	52155-94C10	52155-94C17	52155-94C3	52155-94C4













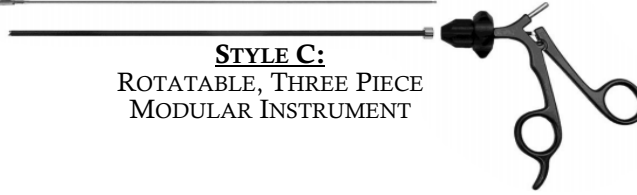





5MM DISSECTORS & GRASPERS



MADE IN THE USA

STYLE C:
ROTATABLE, THREE PIECE
MODULAR INSTRUMENT



TIP ID & LENGTH	HANDLE		INSERT ONLY	TYPE 1	TYPE 9	TYPE 10	TYPE 17	TYPE 3	TYPE 4
	DIAMETER	LENGTH							
				INSULATED HANDLES				NON-INSULATED	
BLUNT ATRAUMATIC GRASPING FORCEPS, DA, 14MM TIP 	5MM	24CM	52224-47I	52224-47C1	52224-47C9	52224-47C10	52224-47C17	52224-47C3	52224-47C4
	5MM	33CM	52255-47I	52255-47C1	52255-47C9	52255-47C10	52255-47C17	52255-47C3	52255-47C4
	5MM	36CM	52236-47I	52236-47C1	52236-47C9	52236-47C10	52236-47C17	52236-47C3	52236-47C4
	5MM	45CM	52155-47I	52155-47C1	52155-47C9	52155-47C10	52155-47C17	52155-47C3	52155-47C4
BLUNT ATRAUMATIC GRASPER W/ CROSS-SERRATED TIPS, DA, 14MM TIP 	5MM	24CM	52224-56I	52224-56C1	52224-56C9	52224-56C10	52224-56C17	52224-56C3	52224-56C4
	5MM	33CM	52255-56I	52255-56C1	52255-56C9	52255-56C10	52255-56C17	52255-56C3	52255-56C4
	5MM	36CM	52236-56I	52236-56C1	52236-56C9	52236-56C10	52236-56C17	52236-56C3	52236-56C4
	5MM	45CM	52155-56I	52155-56C1	52155-56C9	52155-56C10	52155-56C17	52155-56C3	52155-56C4
BULLET NOSE GRASPER TC, MICRO DIAMOND JAW, 15MM TIP 	5MM	24CM	52224-48I	52224-48C1	52224-48C9	52224-48C10	52224-48C17	52224-48C3	52224-48C4
	5MM	33CM	52255-48I	52255-48C1	52255-48C9	52255-48C10	52255-48C17	52255-48C3	52255-48C4
	5MM	36CM	52236-48I	52236-48C1	52236-48C9	52236-48C10	52236-48C17	52236-48C3	52236-48C4
	5MM	45CM	52155-48I	52155-48C1	52155-48C9	52155-48C10	52155-48C17	52155-48C3	52155-48C4
BULLET NOSE GRASPER, TC, CROSS DIAMOND JAW, 15MM TIP 	5MM	24CM	52224-49I	52224-49C1	52224-49C9	52224-49C10	52224-49C17	52224-49C3	52224-49C4
	5MM	33CM	52255-49I	52255-49C1	52255-49C9	52255-49C10	52255-49C17	52255-49C3	52255-49C4
	5MM	36CM	52236-49I	52236-49C1	52236-49C9	52236-49C10	52236-49C17	52236-49C3	52236-49C4
	5MM	45CM	52155-49I	52155-49C1	52155-49C9	52155-49C10	52155-49C17	52155-49C3	52155-49C4
LONG TAPERED GRASPER W/ ATRAUMATIC TEETH 20MM TIP 	5MM	24CM	52224-51I	52224-51C1	52224-51C9	52224-51C10	52224-51C17	52224-51C3	52224-51C4
	5MM	33CM	52255-51I	52255-51C1	52255-51C9	52255-51C10	52255-51C17	52255-51C3	52255-51C4
	5MM	36CM	52236-51I	52236-51C1	52236-51C9	52236-51C10	52236-51C17	52236-51C3	52236-51C4
	5MM	45CM	52155-51I	52155-51C1	52155-51C9	52155-51C10	52155-51C17	52155-51C3	52155-51C4
WAVE GRASPER, POINTED, SA 14MM TIP 	5MM	24CM	52224-54I	52224-54C1	52224-54C9	52224-54C10	52224-54C17	52224-54C3	52224-54C4
	5MM	33CM	52255-54I	52255-54C1	52255-54C9	52255-54C10	52255-54C17	52255-54C3	52255-54C4
	5MM	36CM	52236-54I	52236-54C1	52236-54C9	52236-54C10	52236-54C17	52236-54C3	52236-54C4
	5MM	45CM	52155-54I	52155-54C1	52155-54C9	52155-54C10	52155-54C17	52155-54C3	52155-54C4
"ACCESS" TYPE FENESTRATED GRASPER 20MM TIP 	5MM	24CM	52224-19II	52224-19IC1	52224-19IC9	52224-19IC10	52224-19IC17	52224-19IC3	52224-19IC4
	5MM	33CM	52255-19II	52255-19IC1	52255-19IC9	52255-19IC10	52255-19IC17	52255-19IC3	52255-19IC4
	5MM	36CM	52236-19II	52236-19IC1	52236-19IC9	52236-19IC10	52236-19IC17	52236-19IC3	52236-19IC4
	5MM	45CM	52155-19II	52155-19IC1	52155-19IC9	52155-19IC10	52155-19IC17	52155-19IC3	52155-19IC4











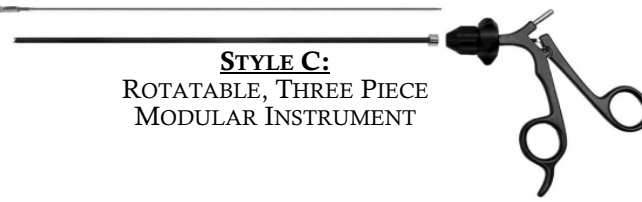







5MM DISSECTORS & GRASPERS



MADE IN THE USA



STYLE C:
ROTATABLE, THREE PIECE
MODULAR INSTRUMENT

TIP ID & LENGTH	HANDLE		INSERT ONLY	TYPE 1	TYPE 9	TYPE 10	TYPE 17	TYPE 3	TYPE 4
	DIAMETER	LENGTH							
				INSULATED HANDLES				NON-INSULATED	
DEBAKEY GRASPER, SA 22MM TIP 	5MM	24CM	52224-122I	52224-122C1	52224-122C9	52224-122C10	52224-122C17	52224-122C3	52224-122C4
	5MM	33CM	52255-122I	52255-122C1	52255-122C9	52255-122C10	52255-122C17	52255-122C3	52255-122C4
	5MM	36CM	52236-122I	52236-122C1	52236-122C9	52236-122C10	52236-122C17	52236-122C3	52236-122C4
	5MM	45CM	52155-122I	52155-122C1	52155-122C9	52155-122C10	52155-122C17	52155-122C3	52155-122C4
STANDARD GRASPER, LONG 20MM TIP 	5MM	24CM	52224-103I	52224-103C1	52224-103C9	52224-103C10	52224-103C17	52224-103C3	52224-103C4
	5MM	33CM	52255-103I	52255-103C1	52255-103C9	52255-103C10	52255-103C17	52255-103C3	52255-103C4
	5MM	36CM	52236-103I	52236-103C1	52236-103C9	52236-103C10	52236-103C17	52236-103C3	52236-103C4
	5MM	45CM	52155-103I	52155-103C1	52155-103C9	52155-103C10	52155-103C17	52155-103C3	52155-103C4
TUBAL GRASPER, DA 10MM TIP 	5MM	24CM	52224-156I	52224-156C1	52224-156C9	52224-156C10	52224-156C17	52224-156C3	52224-156C4
	5MM	33CM	52255-156I	52255-156C1	52255-156C9	52255-156C10	52255-156C17	52255-156C3	52255-156C4
	5MM	36CM	52236-156I	52236-156C1	52236-156C9	52236-156C10	52236-156C17	52236-156C3	52236-156C4
	5MM	45CM	52155-156I	52155-156C1	52155-156C9	52155-156C10	52155-156C17	52155-156C3	52155-156C4
“DAVOL” TYPE, SCOOPED JAW & GENTLY MASH TEETH 15MM TIP 	5MM	24CM	52224-90I	52224-90C1	52224-90C9	52224-90C10	52224-90C17	52224-90C3	52224-90C4
	5MM	33CM	52255-90I	52255-90C1	52255-90C9	52255-90C10	52255-90C17	52255-90C3	52255-90C4
	5MM	36CM	52236-90I	52236-90C1	52236-90C9	52236-90C10	52236-90C17	52236-90C3	52236-90C4
	5MM	45CM	52155-90I	52155-90C1	52155-90C9	52155-90C10	52155-90C17	52155-90C3	52155-90C4
“DAVOL” TYPE, SCOOPED- JAW & 2X3 FRONT TEETH 15MM TIP 	5MM	24CM	52224-190I	52224-190C1	52224-190C9	52224-190C10	52224-190C17	52224-190C3	52224-190C4
	5MM	33CM	52255-190I	52255-190C1	52255-190C9	52255-190C10	52255-190C17	52255-190C3	52255-190C4
	5MM	36CM	52236-190II	52236-190C1	52236-190C9	52236-190C10	52236-190C17	52236-190C3	52236-190C4
	5MM	45CM	52155-190I	52155-190C1	52155-190C9	52155-190C10	52155-190C17	52155-190C3	52155-190C4
NEEDLE NOSE GRASPER, SHORT, SERRATED 11MM TIP 	5MM	24CM	52224-110I	52224-110C1	52224-110C9	52224-110C10	52224-110C17	52224-110C3	52224-110C4
	5MM	33CM	52255-110I	52255-110C1	52255-110C9	52255-110C10	52255-110C17	52255-110C3	52255-110C4
	5MM	36CM	52236-110I	52236-110C1	52236-110C9	52236-110C10	52236-110C17	52236-110C3	52236-110C4
	5MM	45CM	52155-110I	52155-110C1	52155-110C9	52155-110C10	52155-110C17	52155-110C3	52155-110C4
DUAL FENESTRATED GRASPER, SA, CURVED UP TIP 20MM TIP 	5MM	24CM	52224-141I	52224-141C1	52224-141C9	52224-141C10	52224-141C17	52224-141C3	52224-141C4
	5MM	33CM	52255-141I	52255-141C1	52255-141C9	52255-141C10	52255-141C17	52255-141C3	52255-141C4
	5MM	36CM	52236-141I	52236-141C1	52236-141C9	52236-141C10	52236-141C17	52236-141C3	52236-141C4
	5MM	45CM	52155-141I	52155-141C1	52155-141C9	52155-141C10	52155-141C17	52155-141C3	52155-141C4











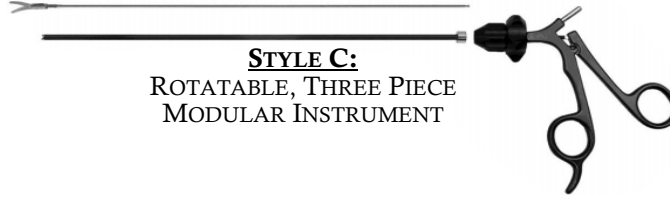

5MM DISSECTORS & GRASPERS



MADE IN THE USA

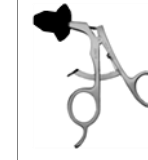

TIP ID & LENGTH	HANDLE		INSERT ONLY	TYPE 1	TYPE 9	TYPE 10	TYPE 17	TYPE 3	TYPE 4
	DIAMETER	LENGTH							
				INSULATED HANDLES				NON-INSULATED	
FENESTRATED GRASPER, AGGRESSIVE 40MM TIP 	5MM	24CM	52224-139I	52224-139C1	52224-139C9	52224-139C10	52224-139C17	52224-139C3	52224-139C4
	5MM	33CM	52255-139I	52255-139C1	52255-139C9	52255-139C10	52255-139C17	52255-139C3	52255-139C4
	5MM	36CM	52236-139I	52236-139C1	52236-139C9	52236-139C10	52236-139C17	52236-139C3	52236-139C4
	5MM	45CM	52155-139I	52155-139C1	52155-139C9	52155-139C10	52155-139C17	52155-139C3	52155-139C4
GRASPING FORCEPS, ELONGATED OVAL CUP 12MM TIP 	5MM	24CM	52224-102I	52224-102C1	52224-102C9	52224-102C10	52224-102C17	52224-102C3	52224-102C4
	5MM	33CM	52255-102I	52255-102C1	52255-102C9	52255-102C10	52255-102C17	52255-102C3	52255-102C4
	5MM	36CM	52236-102I	52236-102C1	52236-102C9	52236-102C10	52236-102C17	52236-102C3	52236-102C4
	5MM	45CM	52155-102I	52155-102C1	52155-102C9	52155-102C10	52155-102C17	52155-102C3	52155-102C4













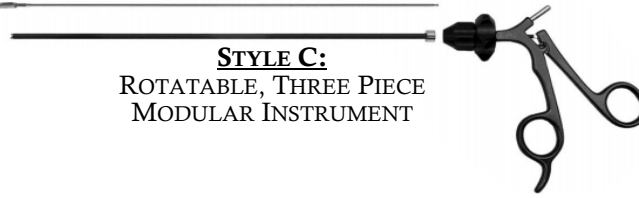





5MM SCISSORS & BIOPSY FORCEPS



MADE IN THE USA

STYLE C:
ROTATABLE, THREE PIECE
MODULAR INSTRUMENT

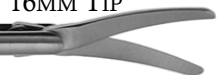

TIP ID & LENGTH	HANDLE		INSERT ONLY	TYPE 1	TYPE 9	TYPE 17	TYPE 23	TYPE 3	TYPE 16
	DIAMETER	LENGTH							
				INSULATED HANDLES				NON-INSULATED	
HOOK SCISSORS, SA 10MM TIP 	5MM	24CM	52224-60I	52224-60C1	52224-60C9	52224-60C17	52224-60C23	52224-60C3	52224-60C16
	5MM	33CM	52255-60I	52255-60C1	52255-60C9	52255-60C17	52255-60C23	52255-60C3	52255-60C16
	5MM	36CM	52236-60I	52236-60C1	52236-60C9	52236-60C17	52236-60C23	52236-60C3	52236-60C16
	5MM	45CM	52155-60I	52155-60C1	52155-60C9	52155-60C17	52155-60C23	52155-60C3	52155-60C16
MICRO TIP SCISSORS, STRAIGHT, SA 5MM TIP 	5MM	24CM	52224-61I	52224-61C1	52224-61C9	52224-61C17	52224-61C23	52224-61C3	52224-61C16
	5MM	33CM	52255-61I	52255-61C1	52255-61C9	52255-61C17	52255-61C23	52255-61C3	52255-61C16
	5MM	36CM	52236-61I	52236-61C1	52236-61C9	52236-61C17	52236-61C23	52236-61C3	52236-61C16
	5MM	45CM	52155-61I	52155-61C1	52155-61C9	52155-61C17	52155-61C23	52155-61C3	52155-61C16
MICRO TIP SCISSORS, CURVED, SA 5MM TIP 	5MM	24CM	52224-62I	52224-62C1	52224-62C9	52224-62C17	52224-62C23	52224-62C3	52224-62C16
	5MM	33CM	52255-62I	52255-62C1	52255-62C9	52255-62C17	52255-62C23	52255-62C3	52255-62C16
	5MM	36CM	52236-62I	52236-62C1	52236-62C9	52236-62C17	52236-62C23	52236-62C3	52236-62C16
	5MM	45CM	52155-62I	52155-62C1	52155-62C9	52155-62C17	52155-62C23	52155-62C3	52155-62C16
METZENBAUM SCISSORS, STRAIGHT, LONG BLADE 20MM TIP 	5MM	24CM	52224-63I	52224-63C1	52224-63C9	52224-63C17	52224-63C23	52224-63C3	52224-63C16
	5MM	33CM	52255-63I	52255-63C1	52255-63C9	52255-63C17	52255-63C23	52255-63C3	52255-63C16
	5MM	36CM	52236-63I	52236-63C1	52236-63C9	52236-63C17	52236-63C23	52236-63C3	52236-63C16
	5MM	45CM	52155-63I	52155-63C1	52155-63C9	52155-63C17	52155-63C23	52155-63C3	52155-63C16
METZENBAUM SCISSORS, STRAIGHT, SHORT BLADE 12MM TIP 	5MM	24CM	52224-64I	52224-64C1	52224-64C9	52224-64C17	52224-64C23	52224-64C3	52224-64C16
	5MM	33CM	52255-64I	52255-64C1	52255-64C9	52255-64C17	52255-64C23	52255-64C3	52255-64C16
	5MM	36CM	52236-64I	52236-64C1	52236-64C9	52236-64C17	52236-64C23	52236-64C3	52236-64C16
	5MM	45CM	52155-64I	52155-64C1	52155-64C9	52155-64C17	52155-64C23	52155-64C3	52155-64C16
METZENBAUM SCISSORS, CURVED, LONG BLADE 16MM TIP 	5MM	24CM	52224-65I	52224-65C1	52224-65C9	52224-65C17	52224-65C23	52224-65C3	52224-65C16
	5MM	33CM	52255-65I	52255-65C1	52255-65C9	52255-65C17	52255-65C23	52255-65C3	52255-65C16
	5MM	36CM	52236-65I	52236-65C1	52236-65C9	52236-65C17	52236-65C23	52236-65C3	52236-65C16
	5MM	45CM	52155-65I	52155-65C1	52155-65C9	52155-65C17	52155-65C23	52155-65C3	52155-65C16
METZENBAUM SCISSORS, WONDER CUT, CURVED BLADE 20MM TIP 	5MM	24CM	52224-265I	52224-265C1	52224-265C9	52224-265C17	52224-265C23	52224-265C3	52224-265C16
	5MM	33CM	52255-265I	52255-265C1	52255-265C9	52255-265C17	52255-265C23	52255-265C3	52255-265C16
	5MM	36CM	52236-265I	52236-265C1	52236-265C9	52236-265C17	52236-265C23	52236-265C3	52236-265C16
	5MM	45CM	52155-265I	52155-265C8	52155-265C9	52155-265C17	52155-265C23	52155-265C3	52155-265C16





5MM SCISSORS & BIOPSY FORCEPS



MADE IN THE USA

STYLE C:
ROTATABLE, THREE PIECE
MODULAR INSTRUMENT

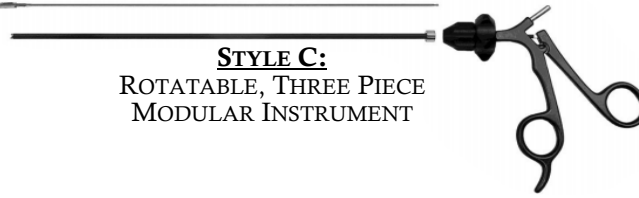

TIP ID & LENGTH	HANDLE		INSERT ONLY	TYPE 1	TYPE 9	TYPE 17	TYPE 23	TYPE 3	TYPE 16
	DIAMETER	LENGTH							
				INSULATED HANDLES				NON-INSULATED	
METZENBAUM SCISSORS, CURVED, SHORT BLADE 12MM TIP 	5MM	24CM	52224-66I	52224-66C1	52224-66C9	52224-66C17	52224-66C23	52224-66C3	52224-66C16
	5MM	33CM	52255-66I	52255-66C1	52255-66C9	52255-66C17	52255-66C23	52255-66C3	52255-66C16
	5MM	36CM	52236-66I	52236-66C1	52236-66C9	52236-66C17	52236-66C23	52236-66C3	52236-66C16
	5MM	45CM	52155-66I	52155-66C1	52155-66C9	52155-66C17	52155-66C23	52155-66C3	52155-66C16
PERITONEAL SCISSORS, SA 15MM TIP 	5MM	24CM	52224-67I	52224-67C1	52224-67C9	52224-67C17	52224-67C23	52224-67C3	52224-67C16
	5MM	33CM	52255-67I	52255-67C1	52255-67C9	52255-67C17	52255-67C23	52255-67C3	52255-67C16
	5MM	36CM	52236-67I	52236-67C1	52236-67C9	52236-67C17	52236-67C23	52236-67C3	52236-67C16
	5MM	45CM	52155-67I	52155-67C1	52155-67C9	52155-67C17	52155-67C23	52155-67C3	52155-67C16
BIOPSY SPOON FORCEPS W/ TOOTH 	5MM	24CM	52224-79I	52224-79C1	52224-79C9	52224-79C17	52224-79C23	52224-79C3	52224-79C16
	5MM	33CM	52255-79I	52255-79C1	52255-79C9	52255-79C17	52255-79C23	52255-79C3	52255-79C16
	5MM	36CM	52236-79I	52236-79C1	52236-79C9	52236-79C17	52236-79C23	52236-79C3	52236-79C16
	5MM	45CM	52155-79I	52155-79C1	52155-79C9	52155-79C17	52155-79C23	52155-79C3	52155-79C16
BIOPSY SPOON FORCEPS, SHORT, SA 10MM TIP 	5MM	24CM	52224-69I	52224-69C1	52224-69C9	52224-69C17	52224-69C23	52224-69C3	52224-69C16
	5MM	33CM	52255-69I	52255-69C1	52255-69C9	52255-69C17	52255-69C23	52255-69C3	52255-69C16
	5MM	36CM	52236-69I	52236-69C1	52236-69C9	52236-69C17	52236-69C23	52236-69C3	52236-69C16
	5MM	45CM	52155-69I	52155-69C1	52155-69C9	52155-69C17	52155-69C23	52155-69C3	52155-69C16
POINTED BIOPSY SPOON FORCEPS, SA 10MM TIP 	5MM	24CM	52224-305I	52224-305C1	52224-305C9	52224-305C17	52224-305C23	52224-305C3	52224-305C16
	5MM	33CM	52255-305I	52255-305C1	52255-305C9	52255-305C17	52255-305C23	52255-305C3	52255-305C16
	5MM	36CM	52236-305I	52236-305C1	52236-305C9	52236-305C17	52236-305C23	52236-305C3	52236-305C16
	5MM	45CM	52155-305I	52155-305C1	52155-305C9	52155-305C17	52155-305C23	52155-305C3	52155-305C16
BIOPSY SPOON FORCEPS, DA 10MM TIP 	5MM	24CM	52224-70I	52224-70C1	52224-70C9	52224-70C17	52224-70C23	52224-70C3	52224-70C16
	5MM	33CM	52255-70I	52255-70C1	52255-70C9	52255-70C17	52255-70C23	52255-70C3	52255-70C16
	5MM	36CM	52236-70I	52236-70C1	52236-70C9	52236-70C17	52236-70C23	52236-70C3	52236-70C16
	5MM	45CM	52155-70I	52155-70C1	52155-70C9	52155-70C17	52155-70C23	52155-70C3	52155-70C16
BIOPSY SPOON FORCEPS, W/ TOOTH (SEMM-TYPE) D/A 10MM TIP 	5MM	24CM	52224-68I	52224-68C1	52224-68C9	52224-68C17	52224-68C23	52224-68C3	52224-68C16
	5MM	33CM	52255-68I	52255-68C1	52255-68C9	52255-68C17	52255-68C23	52255-68C3	52255-68C16
	5MM	36CM	52236-68I	52236-68C1	52236-68C9	52236-68C17	52236-68C23	52236-68C3	52236-68C16
	5MM	45CM	52155-68I	52155-68C1	52155-68C9	52155-68C17	52155-68C23	52155-68C3	52155-68C16











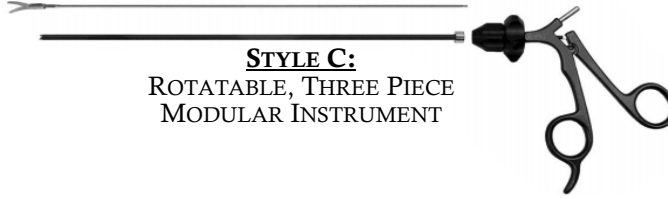

5MM SCISSORS & BIOPSY FORCEPS



MADE IN THE USA

STYLE C:
ROTATABLE, THREE PIECE
MODULAR INSTRUMENT



TIP ID & LENGTH	HANDLE ID		INSERT ONLY	TYPE 1	TYPE 9	TYPE 17	TYPE 23	TYPE 3	TYPE 16
	DIAMETER	LENGTH							
				INSULATED HANDLES				NON-INSULATED	
BIOPSY PUNCH, SA 10MM TIP 	5MM	24CM	52224-71C1	52224-71C8	52224-71C9	52224-71C17	52224-71C23	52224-71C3	52224-71C16
	5MM	33CM	52255-71C1	52255-71C8	52255-71C9	52255-71C17	52255-71C23	52255-71C3	52255-71C16
	5MM	36CM	52236-71C1	52236-71C8	52236-71C9	52236-71C17	52236-71C23	52236-71C3	52236-71C16
	5MM	45CM	52155-71C1	52155-71C8	52155-71C9	52155-71C17	52155-71C23	52155-71C3	52155-71C16
BIOPSY PUNCH W/ TOOTH, SA 10MM TIP 	5MM	24CM	52224-72C1	52224-72C8	52224-72C9	52224-72C17	52224-72C23	52224-72C3	52224-72C16
	5MM	33CM	52255-72C1	52255-72C8	52255-72C9	52255-72C17	52255-72C23	52255-72C3	52255-72C16
	5MM	36CM	52236-72C1	52236-72C8	52236-72C9	52236-72C17	52236-72C23	52236-72C3	52236-72C16
	5MM	45CM	52155-72C1	52155-72C8	52155-72C9	52155-72C17	52155-72C23	52155-72C3	52155-72C16

















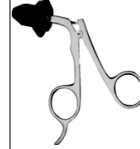

10MM DISSECTORS & GRASPERS



MADE IN THE USA

STYLE C:
ROTATABLE, THREE PIECE
MODULAR INSTRUMENT



TIP ID & LENGTH	HANDLE ID		INSERT ONLY	TYPE 1	TYPE 9	TYPE 10	TYPE 17	TYPE 3	TYPE 4
	DIAMETER	LENGTH							
				INSULATED HANDLES				NON-INSULATED	
MARYLAND DISSECTOR 18MM TIP 	10MM	33CM	52102-06I	52102-06C1	52102-06C9	52102-06C10	52102-06C17	52102-06C3	52102-06C4
	10MM	36CM	52103-06I	52103-06C1	52103-06C9	52103-06C10	52103-06C17	52103-06C3	52103-06C4
	10MM	45CM	52101-06I	52101-06C1	52101-06C9	52101-06C10	52101-06C17	52101-06C3	52101-06C4
RIGHT ANGLE MIXTER, LONG, TEFLON INSERTS 22MM TIP 	10MM	33CM	52102-07I	52102-07C1	52102-07C9	52102-07C10	52102-07C17	52102-07C3	52102-07C4
	10MM	36CM	52103-07I	52103-07C1	52103-07C9	52103-07C10	52103-07C17	52103-07C3	52103-07C4
	10MM	45CM	52101-07I	52101-07C1	52101-07C9	52101-07C10	52101-07C17	52101-07C3	52101-07C4
RIGHT ANGLE MIXTER, SHORT 12MM TIP 	10MM	33CM	52102-59I	52102-59C1	52102-59C9	52102-59C10	52102-59C17	52102-59C3	52102-59C4
	10MM	36CM	52103-59I	52103-59C1	52103-59C9	52103-59C10	52103-59C17	52103-59C3	52103-59C4
	10MM	45CM	52101-59I	52101-59C1	52101-59C9	52101-59C10	52101-59C17	52101-59C3	52101-59C4
45° ANGLED MIXTER 20MM TIP 	10MM	33CM	52102-08I	52102-08C1	52102-08C9	52102-08C10	52102-08C17	52102-08C3	52102-08C4
	10MM	36CM	52103-08I	52103-08C1	52103-08C9	52103-08C10	52103-08C17	52103-08C3	52103-08C4
	10MM	45CM	52101-08CI	52101-08C1	52101-08C9	52101-08C10	52101-08C17	52101-08C3	52101-08C4
BABCOCK GRASPER, FENESTRATED TIP 30MM TIP 	10MM	33CM	52102-16I	52102-16A1	52102-16C9	52102-16C10	52102-16C17	52102-16C3	52102-16C4
	10MM	36CM	52103-16I	52103-16C1	52103-16C9	52103-16C10	52103-16C17	52103-16C3	52103-16C4
	10MM	45CM	52101-16I	52101-16C1	52101-16C9	52101-16C10	52101-16C17	52101-16C3	52101-16C4
ALLIS GRASPER, STD. VERSION 30MM TIP 	10MM	33CM	52102-21I	52102-21C1	52102-21C9	52102-21C10	52102-21C17	52102-21C3	52102-21C4
	10MM	36CM	52103-21I	52103-21C1	52103-21C9	52103-21C10	52103-21C17	52103-21C3	52103-21C4
	10MM	45CM	52101-21I	52101-21C1	52101-21C9	52101-21C10	52101-21C17	52101-21C3	52101-21C4
DEBAKEY GRASPER, 40MM TIP 	10MM	33CM	52102-22I	52102-22C1	52102-22C9	52102-22C10	52102-22C17	52102-22C3	52102-22C4
	10MM	36CM	52103-22I	52103-22C1	52103-22C9	52103-22C10	52103-22C17	52103-22C3	52103-22C4
	10MM	45CM	52101-22I	52101-22C1	52101-22C9	52101-22C10	52101-22C17	52101-22C3	52101-22C4
DEBAKEY GRASPER, 60MM TIP 	10MM	33CM	52102-23I	52102-23C1	52102-23C9	52102-23C10	52102-23C17	52102-23C3	52102-23C4
	10MM	36CM	52103-23I	52103-23C1	52103-23C9	52103-23C10	52103-23C17	52103-23C3	52103-23C4
	10MM	45CM	52101-23I	52101-23C1	52101-23C9	52101-23C10	52101-23C17	52101-23C3	52101-23C4
CLAW GRASPER, 2X3 TEETH, SA 20MM TIP 	10MM	33CM	52102-36I	52102-36C1	52102-36C9	52102-36C10	52102-36C17	52102-36C3	52102-36C4
	10MM	36CM	52103-36I	52103-36C1	52103-36C9	52103-36C10	52103-36C17	52103-36C3	52103-36C4
	10MM	45CM	52101-36I	52101-36C1	52101-36C9	52101-36C10	52101-36C17	52101-36C3	52101-36C4









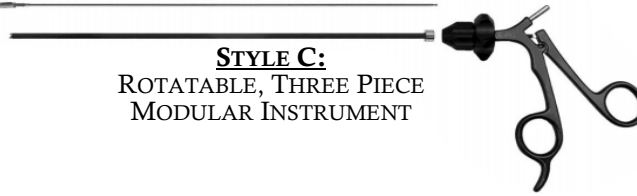





10MM DISSECTORS & GRASPERS

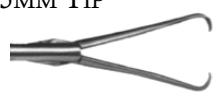

MADE IN THE USA



TIP ID & LENGTH	HANDLE ID		INSERT ONLY	TYPE 1	TYPE 9	TYPE 10	TYPE 17	TYPE 3	TYPE 4
	DIAMETER	LENGTH							
				INSULATED HANDLES				NON-INSULATED	
SCHROEDER TEN, SINGLE TOOTH 25MM TIP 	10MM	33CM	52102-45I	52102-45C8	52102-45C9	52102-45C10	52102-45C17	52102-45C3	52102-45C4
	10MM	36CM	52103-45I	52103-45C8	52103-45C9	52103-45C10	52103-45C17	52103-45C3	52103-45C4
	10MM	45CM	52101-45I	52101-45C8	52101-45C9	52101-45C10	52101-45C17	52101-45C3	52101-45C4
US BABCOCK, SPRING TENSION, ATRAUMATIC 22MM TIP 	10MM	33CM	52102-17I	52102-17C8	52102-17C9	52102-17C10	52102-17C17	52102-17C3	52102-17C4
	10MM	36CM	52103-17I	52103-17C8	52103-17C9	52103-17C10	52103-17C17	52103-17C3	52103-17C4
	10MM	45CM	52101-17I	52101-17C8	52101-17C9	52101-17C10	52101-17C17	52101-17C3	52101-17C4
DUVAL GRASPER, AXIAL SERRATIONS 40MM TIP 	10MM	33CM	52102-26I	52102-26C8	52102-26C9	52102-26C10	52102-26C17	52102-26C3	52102-26C4
	10MM	36CM	52103-26I	52103-26C8	52103-26C9	52103-26C10	52103-26C17	52103-26C3	52103-26C4
	10MM	45CM	52101-26I	52101-26C8	52101-26C9	52101-26C10	52101-26C17	52101-26C3	52101-26C4
STRONG ATRAUMATIC CLAMP, STRAIGHT JAW 40MM TIP 	10MM	33CM	52102-46I	52102-46C8	52102-46C9	52102-46C10	52102-46C17	52102-46C3	52102-46C4
	10MM	36CM	52103-46I	52103-46C8	52103-46C9	52103-46C10	52103-46C17	52103-46C3	52103-46C4
	10MM	45CM	52101-46I	52101-46C8	52101-46C9	52101-46C10	52101-46C17	52101-46C3	52101-46C4
STRONG ATRAUMATIC CLAMP, CURVED JAW 40MM TIP 	10MM	33CM	52102-47I	52102-47C8	52102-47C9	52102-47C10	52102-47C17	52102-47C3	52102-47C4
	10MM	36CM	52103-47I	52103-47C8	52103-47C9	52103-47C10	52103-47C17	52103-47C3	52103-47C4
	10MM	45CM	52101-47I	52101-47C8	52101-47C9	52101-47C10	52101-47C17	52101-47C3	52101-47C4
ANVIL GRASPER TO GRASP & HOLD ANVIL 10MM TIP 	10MM	33CM	52102-20I	52102-20C8	52102-20C9	52102-20C10	52102-20C17	52102-20C3	52102-20C4
	10MM	36CM	52103-20I	52103-20C8	52103-20C9	52103-20C10	52103-20C17	52103-20C3	52103-20C4
	10MM	45CM	52101-20I	52101-20C8	52101-20C9	52101-20C10	52101-20C17	52101-20C3	52101-20C4









10MM DISSECTORS & GRASPERS

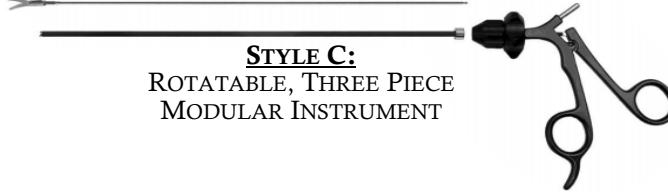

MADE IN THE USA

STYLE C:
ROTATABLE, THREE PIECE
MODULAR INSTRUMENT



TIP ID & LENGTH	HANDLE ID		INSERT ONLY	TYPE 1	TYPE 9	TYPE 17	TYPE 23	TYPE 3	TYPE 16
	DIAMETER	LENGTH		INSULATED HANDLES				NON-INSULATED	
				INSULATED HANDLES				NON-INSULATED	
STRAIGHT SCISSORS, SA 20MM TIP 	10MM	33CM	52102-64I	52102-64C1	52102-64C9	52102-64C10	52102-64C17	52102-64C3	52102-64C4
	10MM	36CM	52103-64I	52103-64C1	52103-64C9	52103-64C10	52103-64C17	52103-64C3	52103-64C4
	10MM	45CM	52101-64I	52101-64C1	52101-64C9	52101-64C10	52101-64C17	52101-64C3	52101-64C4
CURVED SCISSORS, DA 20MM TIP 	10MM	33CM	52102-66I	52102-66C1	52102-66C9	52102-66C10	52102-66C17	52102-66C3	52102-66C4
	10MM	36CM	52103-66I	52103-66C1	52103-66C9	52103-66C10	52103-66C17	52103-66C3	52103-66C4
	10MM	45CM	52101-66I	52101-66C1	52101-66C9	52101-66C10	52101-66C17	52101-66C3	52101-66C4
BIOPSY SPOON FORCEPS, SHORT, SA 10MM TIP 	10MM	33CM	52102-37I	52102-37C1	52102-37C9	52102-37C10	52102-37C17	52102-37C3	52102-37C4
	10MM	36CM	52103-37I	52103-37C1	52103-37C9	52103-37C10	52103-37C17	52103-37C3	52103-37C4
	10MM	45CM	52101-37I	52101-37C1	52101-37C9	52101-37C10	52101-37C17	52101-37C3	52101-37C4
BIOPSY SPOON FORCEPS, LONG, SA 25MM TIP 	10MM	33CM	52102-38I	52102-38C1	52102-38C9	52102-38C10	52102-38C17	52102-38C3	52102-38C4
	10MM	36CM	52103-38I	52103-38C1	52103-38C9	52103-38C10	52103-38C17	52103-38C3	52103-38C4
	10MM	45CM	52101-38I	52101-38C1	52101-38C9	52101-38C10	52101-38C17	52101-38C3	52101-38C4



SURE-GRIP SERIES

SURE-GRIP SLIDE-LOCK HANDLE GRASPERS *WHEN SLIPPING IS NOT AN OPTION*



THE SURE-GRIP 5MM & 10MM GRASPERS HAVE *POSITIVE, PRECISE ACTION* FOR SURE-GRIP GRASPING & RETRACTION.
AVAILABLE IN ONE-PIECE RIGID, ONE-PIECE ROTATABLE & THREE-PIECE SCREW APART INSTRUMENTS

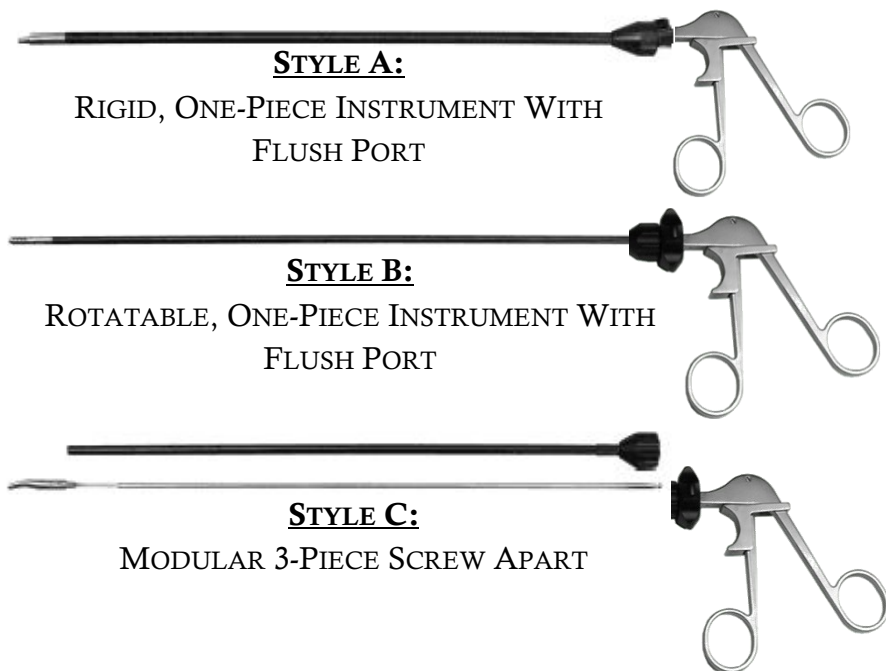

STYLE A:

RIGID, ONE-PIECE INSTRUMENT WITH
FLUSH PORT

STYLE B:

ROTATABLE, ONE-PIECE INSTRUMENT WITH
FLUSH PORT

STYLE C:

MODULAR 3-PIECE SCREW APART









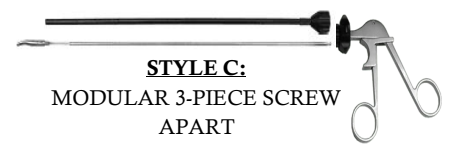
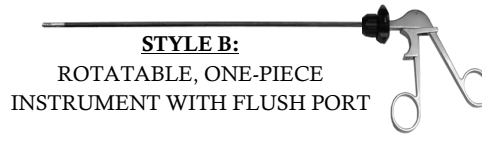
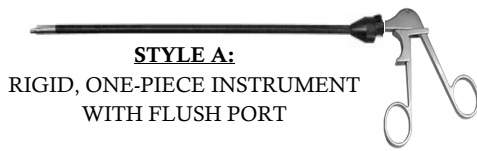

GRASPERS



MADE IN THE USA



TIP ID.	DESCRIPTION	DIAMETER	LENGTH	INSERT NO.	STYLE A: RIGID, ONE-PIECE INSTRUMENT WITH FLUSH PORT	STYLE B: ROTATABLE, ONE-PIECE INSTRUMENT WITH FLUSH PORT	STYLE C: MODULAR 3- PIECE SCREW APART
 12MM JAW	STANDARD GRASPER W/ SPOON	5MM	24CM	52224-02I	52624-02A	52624-02B	52624-02C
		5MM	33CM	52255-02I	52605-02A	52605-02B	52605-02C
		5MM	36CM	52236-02I	52636-02A	52636-02B	52636-02C
		5MM	45CM	52155-02I	52615-02A	52615-02B	52615-02C
 12MM JAW	STANDARD GRASPER	5MM	24CM	52224-03I	52624-03A	52624-03B	52624-03C
		5MM	33CM	52255-03I	52605-03A	52605-03B	52605-03C
		5MM	36CM	52236-03I	52636-03A	52636-03B	52636-03C
		5MM	45CM	52155-03I	52615-03A	52615-03B	52615-03C
 15MM JAW	TAPERED DOLPHIN-NOSE	5MM	24CM	52224-05I	52624-05A	52624-05B	52624-05C
		5MM	33CM	52255-05I	52605-05A	52605-05B	52605-05C
		5MM	36CM	52236-05I	52636-05A	52636-05B	52636-05C
		5MM	45CM	52155-05I	52615-05A	52615-05B	52615-05C
 12MM JAW	TAPERED DOLPHIN-NOSE W/ SPOON	5MM	24CM	52224-105I	52624-105A	52624-105B	52624-105C
		5MM	33CM	52255-105I	52605-105A	52605-105B	52605-105C
		5MM	36CM	52236-105I	52636-105A	52636-105B	52636-105C
		5MM	45CM	52155-105I	52615-105A	52615-105B	52615-105C
 10MM JAW	COBRA GRASPER, DA	5MM	24CM	52224-15I	52624-15A	52624-15B	52624-15C
		5MM	33CM	52255-15I	52605-15A	52605-15B	52605-15C
		5MM	36CM	52236-15I	52636-15A	52636-15B	52636-15C
		5MM	45CM	52155-15I	52615-15A	52615-15B	52615-15C
 30MM JAW	BABCOCK GRASPER, FENESTRATED TIP	5MM	24CM	52224-16I	52624-16A	52624-16B	52624-16C
		5MM	33CM	52255-16I	52605-16A	52605-16B	52605-16C
		5MM	36CM	52236-16I	52636-16A	52636-16B	52636-16C
		5MM	45CM	52155-16I	52615-16A	52615-16B	52615-16C
 30MM JAW	BABCOCK GRASPER, AXIS STYLE, FENESTRATED	5MM	24CM	52224-116I	52624-116A	52624-116B	52624-116C
		5MM	33CM	52255-116I	52605-116A	52605-116B	52605-116C
		5MM	36CM	52236-116I	52636-116A	52636-116B	52636-116C
		5MM	45CM	52155-116I	52615-116A	52615-116B	52615-116C
 10MM JAW	BABCOCK GRASPER, SHORT DELICATE	5MM	24CM	52224-17I	52624-17A	52624-17B	52624-17C
		5MM	33CM	52255-17I	52605-17A	52605-17B	52605-17C
		5MM	36CM	52236-17I	52636-17A	52636-17B	52636-17C
		5MM	45CM	52155-17I	52615-17A	52615-17B	52615-17C





GRASPERS



MADE IN THE USA

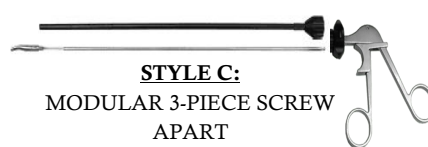
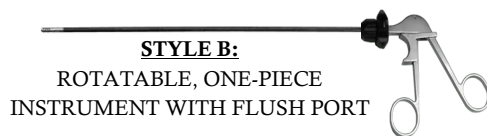
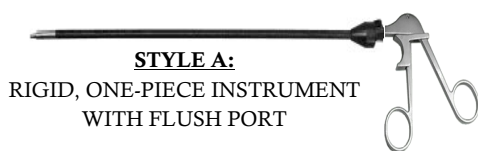

TIP ID.	DESCRIPTION	DIAMETER	LENGTH	INSERT NO.	STYLE A: RIGID, ONE-PIECE INSTRUMENT WITH FLUSH PORT	STYLE B: ROTATABLE, ONE-PIECE INSTRUMENT WITH FLUSH PORT	STYLE C: MODULAR 3- PIECE SCREW APART
15MM JAW	ALLIS GRASPER, SHORT VERSION, SA	5MM	24CM	52224-18I	52624-18A	52624-18B	52624-18C
		5MM	33CM	52255-18I	52605-18A	52605-18B	52605-18C
		5MM	36CM	52236-18I	52636-18A	52636-18B	52636-18C
		5MM	45CM	52155-18I	52615-18A	52615-18B	52615-18C
12MM JAW	ALLIS, SHORT VERSION, 3X4 TEETH, SERRATED	5MM	24CM	52224-19I	52624-19A	52624-19B	52624-19C
		5MM	33CM	52255-19I	52605-19A	52605-19B	52605-19C
		5MM	36CM	52236-19I	52636-19A	52636-19B	52636-19C
		5MM	45CM	52155-19I	52615-19A	52615-19B	52615-19C
12MM JAW	ALLIS, SHORT VERSION, DBL. ROW OF TEETH, SERRATED	5MM	24CM	52224-119I	52624-119A	52624-119B	52624-119C
		5MM	33CM	52255-119I	52605-119A	52605-119B	52605-119C
		5MM	36CM	52236-119I	52636-119A	52636-119B	52636-119C
		5MM	45CM	52155-119I	52615-119A	52615-119B	52615-119C
25MM JAW	ALLIS, LONG VERSION, DBL. ROW OF TEETH, SERRATED	5MM	24CM	52224-219I	52624-219A	52624-219B	52624-219C
		5MM	33CM	52255-219I	52605-219A	52605-219B	52605-219C
		5MM	36CM	52236-219I	52636-219A	52636-219B	52636-219C
		5MM	45CM	52155-219I	52615-219A	52615-219B	52615-219C
20MM JAW	ALLIS GRASPER, MEDIUM, WECK STYLE	5MM	24CM	52224-20I	52624-20A	52624-20B	52624-20C
		5MM	33CM	52255-20I	52605-20A	52605-20B	52605-20C
		5MM	36CM	52236-20I	52636-20A	52636-20B	52636-20C
		5MM	45CM	52155-20I	52615-20A	52615-20B	52615-20C
30MM JAW	ALLIS GRAPER, STD. VERSION	5MM	24CM	52224-21I	52624-21A	52624-21B	52624-21C
		5MM	33CM	52255-21I	52605-21A	52605-21B	52605-21C
		5MM	36CM	52236-21I	52636-21A	52636-21B	52636-21C
		5MM	45CM	52155-21I	52615-21A	52615-21B	52615-21C
35MM JAW	ALLIS GRASPER, TC, STD. VERSION	5MM	24CM	52224-57I	52624-57A	52624-57B	52624-57C
		5MM	33CM	52255-57I	52605-57A	52605-57B	52605-57C
		5MM	36CM	52236-57I	52636-57A	52636-57B	52636-57C
		5MM	45CM	52155-57I	52615-57A	52615-57B	52615-57C
20MM JAW	DEBAKEY GRASPER	5MM	24CM	52224-22I	52624-22A	52624-22B	52624-22C
		5MM	33CM	52255-22I	52605-22A	52605-22B	52605-22C
		5MM	36CM	52236-22I	52636-22A	52636-22B	52636-22C
		5MM	45CM	52155-22I	52615-22A	52615-22B	52615-22C





GRASPERS



MADE IN THE USA

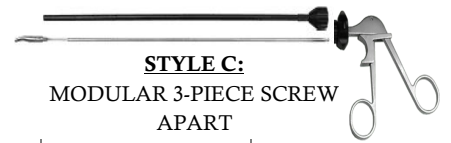
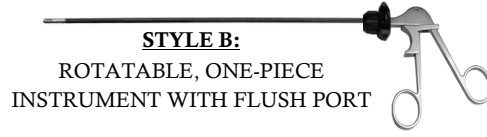
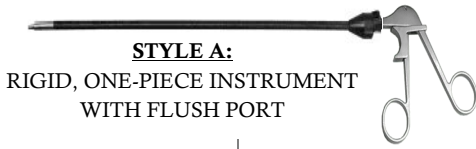

TIP ID.	DESCRIPTION	DIAMETER	LENGTH	INSERT NO.	STYLE A: RIGID, ONE-PIECE INSTRUMENT WITH FLUSH PORT	STYLE B: ROTATABLE, ONE-PIECE INSTRUMENT WITH FLUSH PORT	STYLE C: MODULAR 3- PIECE SCREW APART
40MM JAW	DEBAKEY GRASPER	5MM	24CM	52224-23I	52624-23A	52624-23B	52624-23C
		5MM	33CM	52255-23I	52605-23A	52605-23B	52605-23C
		5MM	36CM	52236-23I	52636-23A	52636-23B	52636-23C
		5MM	45CM	52155-23I	52615-23A	52615-23B	52615-23C
60MM JAW	DEBAKEY GRASPER	5MM	24CM	52224-123I	52624-123A	52624-123B	52624-123C
		5MM	33CM	52255-123I	52605-123A	52605-123B	52605-123C
		5MM	36CM	52236-123I	52636-123A	52636-123B	52636-123C
		5MM	45CM	52155-123I	52615-123A	52615-123B	52615-123C
20MM JAW	HUNTER DEBAKEY, FENESTRATED	5MM	24CM	52224-58I	52624-58A	52624-58B	52624-58C
		5MM	33CM	52255-58I	52605-58A	52605-58B	52605-58C
		5MM	36CM	52236-58I	52636-58A	52636-58B	52636-58C
		5MM	45CM	52155-58I	52615-58A	52615-58B	52615-58C
40MM JAW	HUNTER DEBAKEY, FENESTRATED	5MM	24CM	52224-159I	52624-159A	52624-159B	52624-159C
		5MM	33CM	52255-159I	52605-159A	52605-159B	52605-159C
		5MM	36CM	52236-159I	52636-159A	52636-159B	52636-159C
		5MM	45CM	52155-159I	52615-159A	52615-159B	52615-159C
60MM JAW	HUNTER DEBAKEY, FENESTRATED	5MM	24CM	52224-160I	52624-160A	52624-160B	52624-160C
		5MM	33CM	52255-160I	52605-160A	52605-160B	52605-160C
		5MM	36CM	52236-160I	52636-160A	52636-160B	52636-160C
		5MM	45CM	52155-160I	52615-160A	52615-160B	52615-160C
30MM JAW	DEBAKEY GRASPER, CURVED	5MM	24CM	52224-46I	52624-46A	52624-46B	52624-46C
		5MM	33CM	52255-46I	52605-46A	52605-46B	52605-46C
		5MM	36CM	52236-46I	52636-46A	52636-46B	52636-46C
		5MM	45CM	52155-46I	52615-46A	52615-46B	52615-46C
35MM JAW	DEBAKEY MARYLAND GRASPER	5MM	24CM	52224-149I	52624-149A	52624-149B	52624-149C
		5MM	33CM	52255-149I	52605-149A	52605-149B	52605-149C
		5MM	36CM	52236-149I	52636-149A	52636-149B	52636-149C
30MM JAW	GLASSMAN ATRAUMATIC GRAPER	5MM	45CM	52155-149I	52615-149A	52615-149B	52615-149C
		5MM	24CM	52224-24I	52624-24A	52624-24B	52624-24C
		5MM	33CM	52255-24I	52605-24A	52605-24B	52605-24C
30MM JAW	GLASSMAN ATRAUMATIC GRAPER	5MM	36CM	52236-24I	52636-24A	52636-24B	52636-24C
		5MM	45CM	52155-24I	52615-24A	52615-24B	52615-24C





GRASPERS



MADE IN THE USA

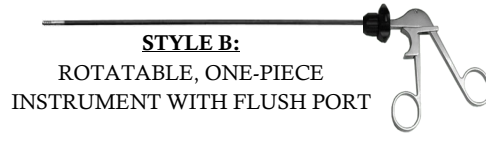
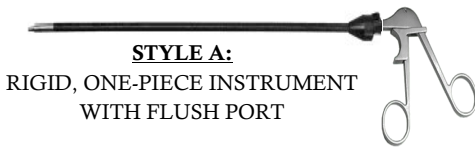

TIP ID.	DESCRIPTION	DIAMETER	LENGTH	INSERT NO.	STYLE A: RIGID, ONE-PIECE INSTRUMENT WITH FLUSH PORT	STYLE B: ROTATABLE, ONE-PIECE INSTRUMENT WITH FLUSH PORT	STYLE C: MODULAR 3- PIECE SCREW APART
16MM JAW	DBL. CUP FUNDUS MAXI GRASPER	5MM	24CM	52224-26I	52624-26A	52624-26B	52624-26C
		5MM	33CM	52255-26I	52605-26A	52605-26B	52605-26C
		5MM	36CM	52236-26I	52636-26A	52636-26B	52636-26C
		5MM	45CM	52155-26I	52615-26A	52615-26B	52615-26C
16MM JAW	"WINER" STYLE FUNDUS GRASPER	5MM	24CM	52224-326I	52624-326A	52624-326B	52624-326C
		5MM	33CM	52255-326I	52605-326A	52605-326B	52605-326C
		5MM	36CM	52236-326I	52636-326A	52636-326B	52636-326C
		5MM	45CM	52155-326I	52615-326A	52615-326B	52615-326C
16MM JAW	"MCKEARNAN" STYLE FUNDUS GRASPER	5MM	24CM	52224-126I	52624-126A	52624-126B	52624-126C
		5MM	33CM	52255-126I	52605-126A	52605-126B	52605-126C
		5MM	36CM	52236-126I	52636-126A	52636-126B	52636-126C
		5MM	45CM	52155-126I	52615-126A	52615-126B	52615-126C
16MM JAW	FENESTRATED DBL. FUNDUS GRASPER	5MM	24CM	52224-226I	52624-226A	52624-226B	52624-226C
		5MM	33CM	52255-226I	52605-226A	52605-226B	52605-226C
		5MM	36CM	52236-226I	52636-226A	52636-226B	52636-226C
		5MM	45CM	52155-226I	52615-226A	52615-226B	52615-226C
20MM JAW	ENDOCLINCH FENESTRATED GRASPER	5MM	24CM	52224-27I	52624-27A	52624-27B	52624-27C
		5MM	33CM	52255-27I	52605-27A	52605-27B	52605-27C
		5MM	36CM	52236-27I	52636-27A	52636-27B	52636-27C
		5MM	45CM	52155-27I	52615-27A	52615-27B	52615-27C
10MM JAW	ALLIGATOR GRASER, RETRO-FACING TEETH, 10MM JAW	5MM	24CM	52224-29I	52624-29A	52624-29B	52624-29C
		5MM	33CM	52255-29I	52605-29A	52605-29B	52605-29C
		5MM	36CM	52236-29I	52636-29A	52636-29B	52636-29C
		5MM	45CM	52155-29I	52615-29A	52615-29B	52615-29C
15MM JAW	ALLIGATOR GRASPER, RETRO-FACING TEETH	5MM	24CM	52224-129I	52624-129A	52624-129B	52624-129C
		5MM	33CM	52255-129I	52605-129A	52605-129B	52605-129C
		5MM	36CM	52236-129I	52636-129A	52636-129B	52636-129C
		5MM	45CM	52155-129I	52615-129A	52615-129B	52615-129C
15MM JAW	GLASSMEN ATRAUMATIC GRASPER	5MM	24CM	52224-30I	52624-30A	52624-30B	52624-30C
		5MM	33CM	52255-30I	52605-30A	52605-30B	52605-30C
		5MM	36CM	52236-30I	52636-30A	52636-30B	52636-30C
		5MM	45CM	52155-30I	52615-30A	52615-30B	52615-30C











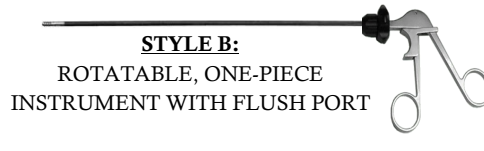
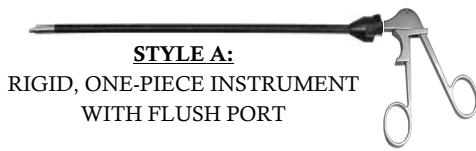

GRASPERS



MADE IN THE USA



TIP ID.	DESCRIPTION	DIAMETER	LENGTH	INSERT NO.	STYLE A: RIGID, ONE-PIECE INSTRUMENT WITH FLUSH PORT	STYLE B: ROTATABLE, ONE-PIECE INSTRUMENT WITH FLUSH PORT	STYLE C: MODULAR 3- PIECE SCREW APART
 22MM JAW	WAVE GRASPER, LONG BEVELED EDGE, DA	5MM	24CM	52224-32I	52624-32A	52624-32B	52624-32C
		5MM	33CM	52255-32I	52605-32A	52605-32B	52605-32C
		5MM	36CM	52236-32I	52636-32A	52636-32B	52636-32C
		5MM	45CM	52155-32I	52615-32A	52615-32B	52615-32C
 22MM JAW	WAVE GRASPER, LONG BEVELED EDGE, SA	5MM	24CM	52224-33I	52624-33A	52624-33B	52624-33C
		5MM	33CM	52255-33I	52605-33A	52605-33B	52605-33C
		5MM	36CM	52236-33I	52636-33A	52636-33B	52636-33C
		5MM	45CM	52155-33I	52615-33A	52615-33B	52615-33C
 20MM JAW	CLAW GRASPER, 2X3 TEETH, SA	5MM	24CM	52224-36I	52624-36A	52624-36B	52624-36C
		5MM	33CM	52255-36I	52605-36A	52605-36B	52605-36C
		5MM	36CM	52236-36I	52636-36A	52636-36B	52636-36C
		5MM	45CM	52155-36I	52615-36A	52615-36B	52615-36C
 20MM JAW	CLAW GRASPER, 2X3 TEETH, W/ XTRA ROW OF TEETH	5MM	24CM	52224-136I	52624-136A	52624-136B	52624-136C
		5MM	33CM	52255-136I	52605-136A	52605-136B	52605-136C
		5MM	36CM	52236-136I	52636-136A	52636-136B	52636-136C
		5MM	45CM	52155-136I	52615-136A	52615-136B	52615-136C
 20MM JAW	RETRACTION GRASPER, 2X3 TEETH, COBRA STYLE, DA	5MM	24CM	52224-34I	52624-34A	52624-34B	52624-34C
		5MM	33CM	52255-34I	52605-34A	52605-34B	52605-34C
		5MM	36CM	52236-34I	52636-34A	52636-34B	52636-34C
		5MM	45CM	52155-34I	52615-34A	52615-34B	52615-34C
 20MM JAW	RETRACTION GRASPER, 2X3 TEETH, COBRA STYLE, SA	5MM	24CM	52224-35I	52624-35A	52624-35B	52624-35C
		5MM	33CM	52255-35I	52605-35A	52605-35B	52605-35C
		5MM	36CM	52236-35I	52636-35A	52636-35B	52636-35C
		5MM	45CM	52155-35I	52615-35A	52615-35B	52615-35C
 20MM JAW	RETRACTION GRASPER, 2X3 TEETH, JARIT STYLE, DA	5MM	24CM	52224-134I	52624-134A	52624-134B	52624-134C
		5MM	33CM	52255-134I	52605-134A	52605-134B	52605-134C
		5MM	36CM	52236-134I	52636-134A	52636-134B	52636-134C
		5MM	45CM	52155-134I	52615-134A	52615-134B	52615-134C
 20MM JAW	RETRACTION GRASPER, 2X3 TEETH, JARIT STYLE, SA	5MM	24CM	52224-135I	52624-135A	52624-135B	52624-135C
		5MM	33CM	52255-135I	52605-135A	52605-135B	52605-135C
		5MM	36CM	52236-135I	52636-135A	52636-135B	52636-135C
		5MM	45CM	52155-135I	52615-135A	52615-135B	52615-135C





GRASPERS



MADE IN THE USA

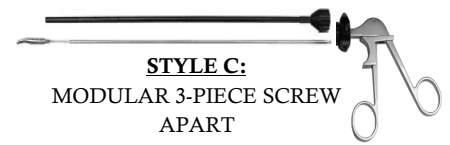
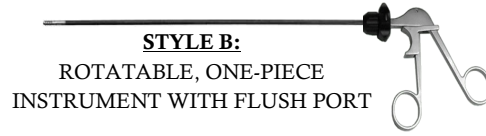
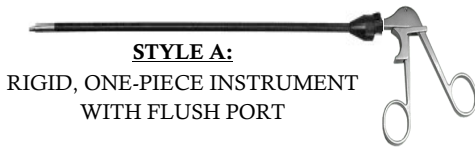

TIP ID.	DESCRIPTION	DIAMETER	LENGTH	INSERT NO.	STYLE A: RIGID, ONE-PIECE INSTRUMENT WITH FLUSH PORT	STYLE B: ROTATABLE, ONE-PIECE INSTRUMENT WITH FLUSH PORT	STYLE C: MODULAR 3- PIECE SCREW APART
16MM JAW	FENESTRATED GRASPER	5MM	24CM	52224-38I	52624-38A	52624-38B	52624-38C
		5MM	33CM	52255-38I	52605-38A	52605-38B	52605-38C
		5MM	36CM	52236-38I	52636-38A	52636-38B	52636-38C
		5MM	45CM	52155-38I	52615-38A	52615-38B	52615--38C
22MM JAW	FENESTRATED GRASPER	5MM	24CM	52224-39I	52624-39A	52624-39B	52624-39C
		5MM	33CM	52255-39I	52605-39A	52605-39B	52605-39C
		5MM	36CM	52236-39I	52636-39A	52636-39B	52636-39C
		5MM	45CM	52155-39I	52615-39A	52615-39B	52615-39C
40MM JAW	FENESTRATED GRASPER	5MM	24CM	52224-40I	52624-40A	52624-40B	52624-40C
		5MM	33CM	52255-40I	52605-40A	52605-40B	52605-40C
		5MM	36CM	52236-40I	52636-40A	52636-40B	52636-40C
		5MM	45CM	52155-40I	52615-40A	52615-40B	52615-40C
20MM JAW	JOHAN FENESTRATED GRASPER, 20MM TIP, SA	5MM	24CM	52224-41I	52624-41A	52624-41B	52624-41C
		5MM	33CM	52255-41I	52605-41A	52605-41B	52605-41C
		5MM	36CM	52236-41I	52636-41A	52636-41B	52636-41C
		5MM	45CM	52155-41I	52615-41A	52615-41B	52615-41C
45MM JAW	JOHAN FENESTRATED GRASPER, 45MM TIP, SA	5MM	24CM	52224-42I	52624-42A	52624-42B	52624-42C
		5MM	33CM	52255-42I	52605-42A	52605-42B	52605-42C
		5MM	36CM	52236-42I	52636-42A	52636-42B	52636-42C
		5MM	45CM	52155-42I	52615-42A	52615-42B	52615-42C
25MM JAW	DBL. FENESTRATED GRASPER	5MM	24CM	52224-139I	52624-139A	52624-139B	52624-139C
		5MM	33CM	52255-139I	52605-139A	52605-139B	52605-139C
		5MM	36CM	52236-139I	52636-139A	52636-139B	52636-139C
		5MM	45CM	52155-139I	52615-139A	52615-139B	52615-139C
25MM JAW	SCHROEDER TENACULUM, SINGLE TOOTH, ROUND TIP	5MM	24CM	52224-45I	52624-45A	52624-45B	52624-45C
		5MM	33CM	52255-45I	52605-45A	52605-45B	52605-45C
		5MM	36CM	52236-45I	52636-45A	52636-45B	52636-45C
		5MM	45CM	52155-134I	52615-134A	52615-134B	52615-134C
25MM JAW	SCHROEDER TENACULUM, SINGLE TOOTH, SQUARE TIP	5MM	24CM	52224-145I	52624-145A	52624-145B	52624-145C
		5MM	33CM	52255-145I	52605-145A	52605-145B	52605-145C
		5MM	36CM	52236-145I	52636-145A	52636-145B	52636-145C
		5MM	45CM	52155-145I	52615-145A	52615-145B	52615-145C









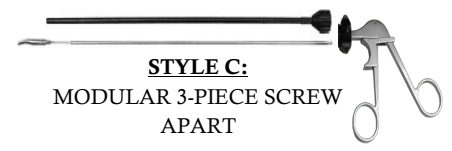
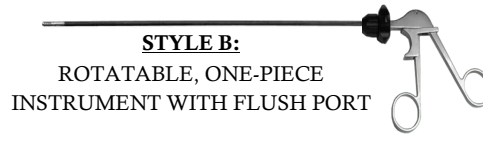
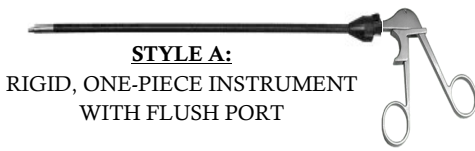

GRASPERS

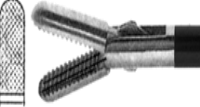

MADE IN THE USA



TIP ID.	DESCRIPTION	DIAMETER	LENGTH	INSERT NO.	STYLE A: RIGID, ONE-PIECE INSTRUMENT WITH FLUSH PORT	STYLE B: ROTATABLE, ONE-PIECE INSTRUMENT WITH FLUSH PORT	STYLE C: MODULAR 3- PIECE SCREW APART
 25MM JAW	SCHROEDER TENACULUM GRASPER, SINGLE TOOTH W/ EXTRA GUIDE TOOTH	5MM	24CM	52224-94I	52624-94A	52624-94B	52624-94C
		5MM	33CM	52255-94I	52605-94A	52605-94B	52605-94C
		5MM	36CM	52236-94I	52636-94A	52636-94B	52636-94C
		5MM	45CM	52155-94I	52615-94A	52615-94B	52615-94C
 15MM JAW	BULLET NOSE GRASPER TC, MICRO DIAMOND JAW PATTERN	5MM	24CM	52224-48I	52624-48A	52624-48B	52624-48C
		5MM	33CM	52255-48I	52605-48A	52605-48B	52605-48C
		5MM	36CM	52236-48I	52636-48A	52636-48B	52636-48C
		5MM	45CM	52155-48I	52615-48A	52615-48B	52615-48C
 15MM JAW	BULLET NOSE GRASPER TC, CROSS DIAMOND JAW PATTERN	5MM	24CM	52224-49I	52624-49A	52624-49B	52624-49C
		5MM	33CM	52255-49I	52605-49A	52605-49B	52605-49C
		5MM	36CM	52236-49I	52636-49A	52636-49B	52636-49C
		5MM	45CM	52155-49I	52615-49A	52615-49B	52615-49C
 15MM JAW	"DAVOL" TYPE, GRASPER, SCOOPED-OUT JAW & GENTLY MASHING TEETH	5MM	24CM	52224-90I	52624-90A	52624-90B	52624-90C
		5MM	33CM	52255-90I	52605-90A	52605-90B	52605-90C
		5MM	36CM	52236-90I	52636-90A	52636-90B	52636-90C
		5MM	45CM	52155-90I	52615-90A	52615-90B	52615-90C
 20MM JAW	"ACCESS" TYPE, FENESTRATED GRASPER	5MM	24CM	52224-42I	52624-42A	52624-42B	52624-42C
		5MM	33CM	52255-42I	52605-42A	52605-42B	52605-42C
		5MM	36CM	52236-42I	52636-42A	52636-42B	52636-42C
		5MM	45CM	52155-42I	52615-42A	52615-42B	52615-42C





*D*ISPOSABLE &
*R*EPOSABLE
*S*ERIES

ELMED IS ONE OF THE LEADERS OF BRINGING OPTIONS TO ALL THAT WANT THEM.

WITH THAT IN MIND, WE BRING YOU THE ELMED DISPOSABLE & REPOSABLE LAP SERIES. SINGLE USE TIPS FOR THOSE WHO WANT TRUE DISPOSABLE INSTRUMENTATION AND REPOSABLE TIPS FOR THOSE WHO WANT TO WATCH THEIR SPENDING.











ELMED REPOSABLE HANDLE & SHAFT W/ DISPOSABLE TIPS



MADE IN THE USA



HANDLE STYLE	ITEM NO.	DESCRIPTION
	52601-05	5MM, 33CM, ROTATABLE, INSULATED, NON-RATCHET HANDLE & SHAFT FOR USE WITH ELMED DISPOSABLE TIPS
	52601-06	5MM, 45CM, ROTATABLE, INSULATED, NON-RATCHET HANDLE & SHAFT FOR USE WITH ELMED DISPOSABLE TIPS
	52601-07	5MM, 33CM, ROTATABLE, INSULATED,, ON DEMAND ON/OFF RATCHET HANDLE & SHAFT FOR USE WITH ELMED DISPOSABLE TIPS
	52601-08	5MM, 45CM, ROTATABLE, INSULATED,, ON DEMAND ON/OFF RATCHET HANDLE & SHAFT FOR USE WITH ELMED DISPOSABLE TIPS

TIP STYLE	ITEM NO.	DESCRIPTION
	52600-01	TIP ONLY DISPOSABLE CURVED MINI METZENBAUM TIPS - STERILE (10 PKG) FOR 52601-05 + 52601-06 + 52601-07 + 52601-08 HANDLE
	52600-02	TIP ONLY DISPOSABLE CURVED METZENBAUM TIPS - STERILE (10 PKG) FOR 52601-05 + 52601-06 + 52601-07 + 52601-08 HANDLE
	52600-03	TIP ONLY DISPOSABLE MARYLAND TIPS - STERILE (10 PKG) FOR 52601-05 + 52601-06 + 52601-07 + 52601-08 HANDLE
	52600-04	TIP ONLY DISPOSABLE FENESTRATED GRASPER, SHORT, TIPS - STERILE (10 PKG) FOR 52601-05 + 52601-06 + 52601-07 + 52601-08 HANDLE
	52600-05	TIP ONLY DISPOSABLE ENDO CLINCH GRASPER TIPS - STERILE (10 PKG) FOR 52601-05 + 52601-06 + 52601-07 + 52601-08 HANDLE
	52600-06	TIP ONLY DISPOSABLE FENESTRATED GRASPER, LONG, TIPS - STERILE (10 PKG) FOR 52601-05 + 52601-06 + 52601-07 + 52601-08 HANDLE





ELMED REPOSABLE HANDLE & SHAFT W/ REPOSABLE TIPS



MADE IN THE USA









ITEM NO.	DESCRIPTION
52601-09	PEEK HANDLE, NON-RATCHET W/ RF-CONNECTION



ITEM NO.	DESCRIPTION
52601-10	5MM, 33CM, INSULATED SHAFT FOR USE WITH ELMED REPOSABLE TIPS
52601-11	5MM, 45CM, INSULATED SHAFT FOR USE WITH ELMED REPOSABLE TIPS



ITEM NO.	DESCRIPTION
52601-12	5MM, 33CM, CONNECTION ROD W/ EASY SNAP LOCK
52601-13	5MM, 45CM, CONNECTION ROD W/ EASY SNAP LOCK

TIP STYLE	ITEM NO.	DESCRIPTION
	52600-07	TIP ONLY REPOSABLE SMALL CURVED METZENBAUM TIPS - NON-STERILE (10 PKG)
	52600-08	TIP ONLY REPOSABLE MEDIUM CURVED METZENBAUM TIPS - NON-STERILE (10 PKG)
	52600-09	TIP ONLY REPOSABLE LARGE CURVED METZENBAUM TIPS - NON-STERILE (10 PKG)
	52600-11	TIP ONLY REPOSABLE MEDIUM STRAIGHT METZENBAUM TIPS - NON-STERILE (10 PKG)
	52600-12	TIP ONLY REPOSABLE LARGE STRAIGHT METZENBAUM TIPS - NON-STERILE (10 PKG)
	52600-13	TIP ONLY REPOSABLE MARYLAND TIP - NON-STERILE (10 PKG)
	52600-14	TIP ONLY REPOSABLE ENDO CLINCH GRASPER TIPS - NON-STERILE (10 PKG)





TRADITIONAL SERIES

ELMED IS ONE OF THE LEADERS AND PIONEERS IN THE FIELD OF LAPAROSCOPIC INSTRUMENTS AND RELATED EQUIPMENT.













OUR INSTRUMENTS HAVE BEEN DEVELOPED IN CLOSE COOPERATION WITH LEADING SURGEONS. THEY ARE COMPLETELY REUSABLE, UNCOMPROMISING IN QUALITY AND DURABILITY, YET SIMPLE IN OPERATION AND MAINTENANCE.



TRADITIONAL 5MM LAPAROSCOPIC INSTRUMENTS



MADE IN THE USA

TIP ID.	DESCRIPTION	DIAMETER	LENGTH	STANDARD	SPRING	RATCHET
	HOOK SCISSORS	5MM	33CM	52502-01A	52502-01B	52502-01C
		5MM	36CM	52503-01A	52503-01B	52503-01C
		5MM	45CM	52501-01A	52501-01B	52501-01C
	PERITONEAL SCISSORS	5MM	33CM	52502-02A	52502-02B	52502-02C
		5MM	36CM	52503-02A	52503-02B	52503-02C
		5MM	45CM	52501-02A	52501-02B	52501-02C
	SERRATED SCISSORS	5MM	33CM	52502-03A	52502-03B	52502-03C
		5MM	36CM	52503-03A	52503-03B	52503-03C
		5MM	45CM	52501-03A	52501-03B	52501-03C
	METZENBAUM SCISSORS, CURVED	5MM	33CM	52502-04A	52502-04B	52502-04C
		5MM	36CM	52503-04A	52503-04B	52503-04C
		5MM	45CM	52501-04A	52501-04B	52501-04C
	POINTED SPOON FORCEPS	5MM	33CM	52502-05A	52502-05B	52502-05C
		5MM	36CM	52503-05A	52503-05B	52503-05C
		5MM	45CM	52501-05A	52501-05B	52501-05C
	SPOON FORCEPS	5MM	33CM	52502-06A	52502-06B	52502-06C
		5MM	36CM	52503-06A	52503-06B	52503-06C
		5MM	45CM	52501-06A	52501-06B	52501-06C
	SPOON FORCEPS W/ TEETH	5MM	33CM	52502-07A	52502-07B	52502-07C
		5MM	36CM	52503-07A	52503-07B	52503-07C
		5MM	45CM	52501-07A	52501-07B	52501-07C
	DA SPOON FORCEPS	5MM	33CM	52502-08A	52502-08B	52502-08C
		5MM	36CM	52503-08A	52503-08B	52503-08C
		5MM	45CM	52501-08A	52501-08B	52501-08C
	DA SPOON FORCEPS W/ TEETH	5MM	33CM	52502-09A	52502-09B	52502-09C
		5MM	36CM	52503-09A	52503-09B	52503-09C
		5MM	45CM	52501-09A	52501-09B	52501-09C
	BIOPSY PUNCH FORCEPS	5MM	33CM	52502-10A	52502-10B	52502-10C
		5MM	36CM	52503-10A	52503-10B	52503-10C
		5MM	45CM	52501-10A	52501-10B	52501-10C
	BIOPSY PUNCH W/ TEETH	5MM	33CM	52502-11A	52502-11B	52502-11C
		5MM	36CM	52503-11A	52503-11B	52503-11C
		5MM	45CM	52501-11A	52501-11B	52501-11C
	HOOK PUNCH	5MM	33CM	52502-12A	52502-12B	52502-12C
		5MM	36CM	52503-12A	52503-12B	52503-12C
		5MM	45CM	52501-12A	52501-12B	52501-12C















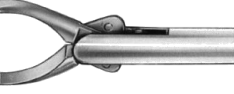

TRADITIONAL 5MM LAPAROSCOPIC INSTRUMENTS



MADE IN THE USA

TIP ID.	DESCRIPTION	DIAMETER	LENGTH	 STANDARD	 SPRING	 RATCHET
	STANDARD GRASPER W/ SPOON	5MM	33CM	52502-13A	52502-13B	52502-13C
		5MM	36CM	52503-13A	52503-13B	52503-13C
		5MM	45CM	52501-13A	52501-13B	52501-13C
	POINTED GRASPER W/ SPOON	5MM	33CM	52502-14A	52502-14B	52502-14C
		5MM	36CM	52503-14A	52503-14B	52503-14C
		5MM	45CM	52501-14A	52501-14B	52501-14C
	STANDARD GRASPER	5MM	33CM	52502-15A	52502-15B	52502-15C
		5MM	36CM	52503-15A	52503-15B	52503-15C
		5MM	45CM	52501-15A	52501-15B	52501-15C
	BACKBITING GRASPER	5MM	33CM	52502-16A	52502-16B	52502-16C
		5MM	36CM	52503-16A	52503-16B	52503-16C
		5MM	45CM	52501-16A	52501-16B	52501-16C
	ATRAUMATIC GRASPER	5MM	33CM	52502-17A	52502-17B	52502-17C
		5MM	36CM	52503-17A	52503-17B	52503-17C
		5MM	45CM	52501-17A	52501-17B	52501-17C
	CLAW GRASPER	5MM	33CM	52502-18A	52502-18B	52502-18C
		5MM	36CM	52503-18A	52503-18B	52503-18C
		5MM	45CM	52501-18A	52501-18B	52501-18C
	PETELIN DISSECTOR 60°	5MM	33CM	52502-19A	52502-19B	52502-19C
		5MM	36CM	52503-19A	52503-19B	52503-19C
		5MM	45CM	52501-19A	52501-19B	52501-19C
	PETELIN DISSECTOR 30°	5MM	33CM	52502-20A	52502-20B	52502-20C
		5MM	36CM	52503-20A	52503-20B	52503-20C
		5MM	45CM	52501-20A	52501-20B	52501-20C
	STRONG RIGHT ANGLE DISSECTOR	5MM	33CM	52502-31A	52502-31B	52502-31C
		5MM	36CM	52503-31A	52503-31B	52503-31C
		5MM	45CM	52501-31A	52501-31B	52501-31C
	SPOON FORCEPS W/ TEETH	5MM	33CM	52502-32A	52502-32B	52502-32C
		5MM	36CM	52503-32A	52503-32B	52503-32C
		5MM	45CM	52501-32A	52501-32B	52501-32C
	SCHROEDER TENACULUM GRASPER, SINGLE TOOTH	5MM	33CM	52502-33A	52502-33B	52502-33C
		5MM	36CM	52503-33A	52503-33B	52503-33C
		5MM	45CM	52501-33A	52501-33B	52501-33C





TRADITIONAL 5MM LAPAROSCOPIC INSTRUMENTS



MADE IN THE USA



ALL STAINLESS STEEL CONSTRUCTION W/
MICRO TIPS & STANDARD HANDLE



CURVED
MICRO
SCISSORS

33CM	52502-21
45CM	52501-21



STRAIGHT
MICRO
SCISSORS

33CM	52502-22
45CM	52501-22



MICRO
GRASPER

33CM	52502-23
45CM	52501-23



DA MICRO
GRASPER

33CM	52502-24
45CM	52501-24



MICRO-
BIOPSY
PUNCH

33CM	52502-25
45CM	52501-25

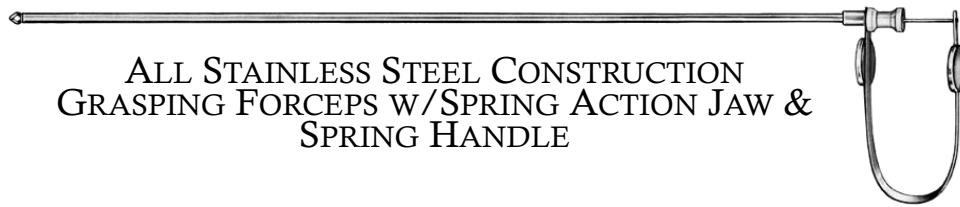

ALL STAINLESS STEEL CONSTRUCTION
GRASPING FORCEPS W/SPRING ACTION JAW &
SPRING HANDLE

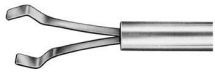

STD.
GRASPER

33CM	52502-50
45CM	52501-50



ATRAUMATIC
GRASPER

33CM	52502-51
45CM	52501-51



ATRAUMATIC
GRASPER W/
STRONG JAW

33CM	52502-52
45CM	52501-52



ROUND
BOWEL
GRASPER

33CM	52502-53
45CM	52501-53



"T" BOWEL
GRASPER

33CM	52502-54
45CM	52501-54



CYST
GRASPER

33CM	52502-55
45CM	52501-55



TUBAL
GRASPER

33CM	52502-56
45CM	52501-56



FENESTRATED
GRASPER

33CM	52502-57
45CM	52501-57



















TRADITIONAL 10MM LAPAROSCOPIC INSTRUMENTS



MADE IN THE USA

TIP ID.	DESCRIPTION	DIAMETER	LENGTH	STANDARD 	SPRING 	RATCHET 
	STRAIGHT SCISSORS	10MM	33CM	52112-01A	52112-01B	52112-01C
		10MM	36CM	52113-01A	52113-01B	52113-01C
		10MM	45CM	52111-01A	52111-01B	52111-01C
	SPOON FORCEPS	10MM	33CM	52112-02A	52112-02B	52112-02C
		10MM	36CM	52113-02A	52113-02B	52113-02C
		10MM	45CM	52111-02A	52111-02B	52111-02C
	CLAW FORCEPS	10MM	33CM	52112-03A	52112-03B	52112-03C
		10MM	36CM	52113-03A	52113-03B	52113-03C
		10MM	45CM	52111-03A	52111-03B	52111-03C
	GRASPING FORCEPS	10MM	33CM	52112-04A	52112-04B	52112-04C
		10MM	36CM	52113-04A	52113-04B	52113-04C
		10MM	45CM	52111-04A	52111-04B	52111-04C
	DEBAKEY FORCEPS	10MM	33CM	52112-05A	52112-05B	52112-05C
		10MM	36CM	52113-05A	52113-05B	52113-05C
		10MM	45CM	52111-05A	52111-05B	52111-05C
	BABCOCK FORCEPS	10MM	33CM	52112-07A	52112-07B	52112-07C
		10MM	36CM	52113-07A	52113-07B	52113-07C
		10MM	45CM	52111-07A	52111-07B	52111-07C
	ALLIS FORCEPS	10MM	33CM	52112-08A	52112-08B	52112-08C
		10MM	36CM	52113-08A	52113-08B	52113-08C
		10MM	45CM	52111-08A	52111-08B	52111-08C
	MARYLAND FORCEPS	10MM	33CM	52112-09A	52112-09B	52112-09C
		10MM	36CM	52113-09A	52113-09B	52113-09C
		10MM	45CM	52111-09A	52111-09B	52111-09C
	MIXTER FORCEPS 90°	10MM	33CM	52112-10A	52112-10B	52112-10C
		10MM	36CM	52113-10A	52113-10B	52113-10C
		10MM	45CM	52111-10A	52111-10B	52111-10C
	DUVAL FORCEPS	10MM	33CM	52112-11A	52112-11B	52112-11C
		10MM	36CM	52113-11A	52113-11B	52113-11C
		10MM	45CM	52111-11A	52111-11B	52111-11C
	TENACULUM FORCEPS	10MM	33CM	52112-15A	52112-15B	52112-15C
		10MM	36CM	52113-15A	52113-15B	52113-15C
		10MM	45CM	52111-15A	52111-15B	52111-15C
	GLASSMAN FORCEPS	10MM	33CM	52112-16A	52112-16B	52112-16C
		10MM	36CM	52113-16A	52113-16B	52113-16C
		10MM	45CM	52111-16A	52111-16B	52111-16C



SUTURE & LIGATURE INSTRUMENTS

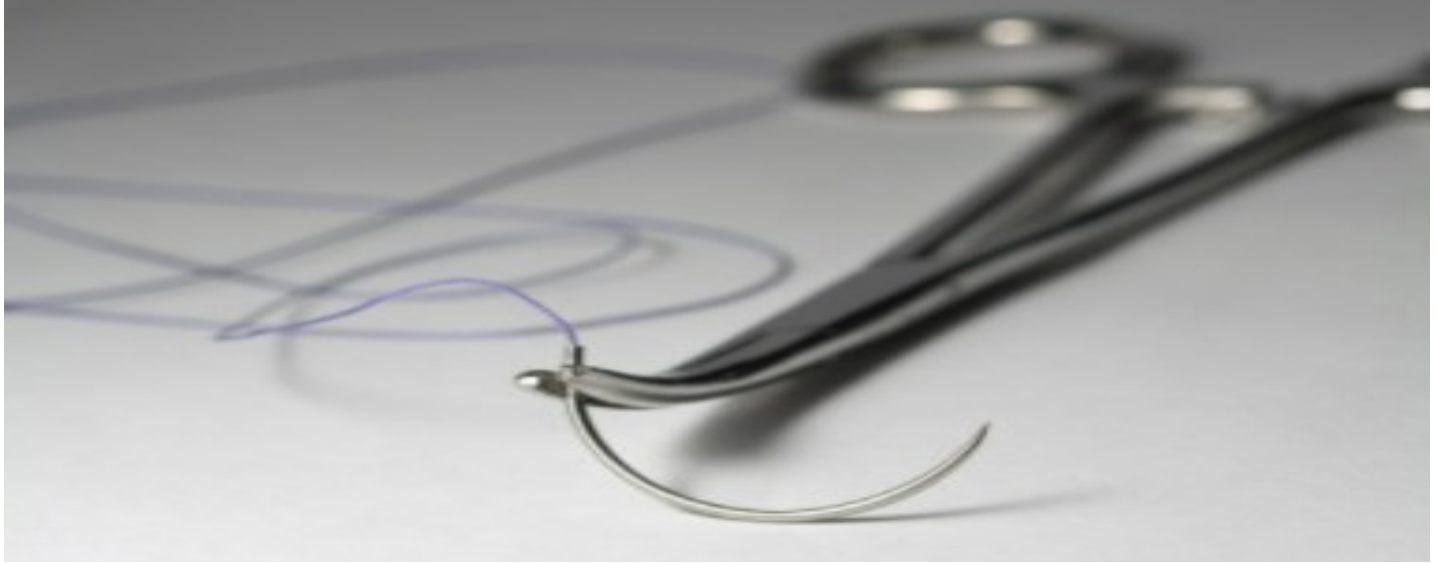

ELMED LAPAROSCOPIC NEEDLE HOLDERS, OUR PRECISION ENGINEERED NEEDLE HOLDERS, GIVE THE FEELING OF “OPEN SURGICAL PROCEDURE.” THEY ARE DESIGNED WITH HANDLES THAT MINIMIZE HAND FATIGUE, MAXIMIZE HOLDING POWER AND ALLOW A NATURAL ROTATION OF THE WRIST.

ELMED CLIP APPLIERS ARE 5MM DIAMETER AND 10MM DIAMETER REUSABLE, SINGLE-ACTION CLIP APPLIERS FOR LAPAROSCOPIC SURGERY PROCEDURES.



ELMED LAPAROSCOPIC 5MM CLIP APPLIERS



MADE IN THE USA

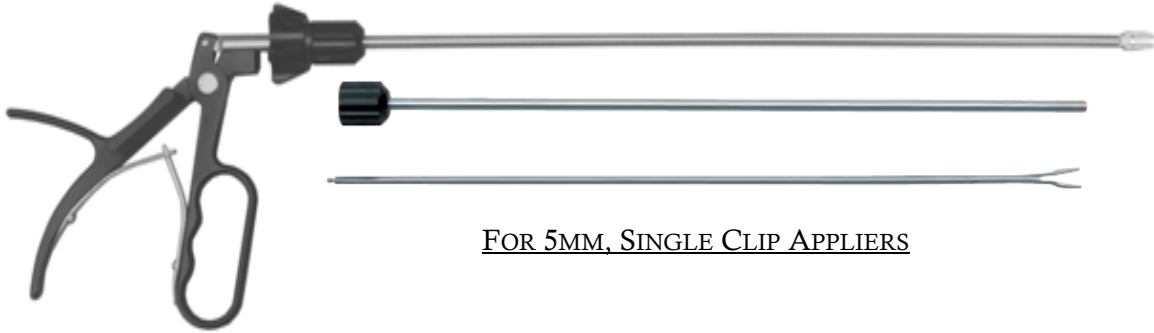

FOR 5MM, SINGLE CLIP APPLIERS

FEATURES FOR 5 CLIP APPLIERS:

- MODULAR, 3-PIECE SCREW-APART INSTRUMENT FOR SIMPLE CLEANING & MAINTENANCE
- CONSTRUCTED OF THE HIGHEST GRADE STAINLESS STEEL
- DURABLE, NON-DEFORMING JAW FOR CONSISTENT CLIP APPLICATION

FOR USE WITH THE FOLLOWING

CLIPS:

- ETHICON
- WECK
- PILLING
- HORIZON

ITEM NO.	DESCRIPTION
52533-01C	5MM, 33CM, LAP CLIP APPLICATOR, ETHICON SMALL, ROTATABLE, 3-PIECE DETACHABLE
52533-02C	5MM, 33CM, LAP CLIP APPLICATOR, ETHICON MEDIUM, ROTATABLE, 3-PIECE DETACHABLE
52533-11C	5MM, 33CM, LAP CLIP APPLICATOR, WECK SMALL, ROTATABLE, 3-PIECE DETACHABLE
52533-12C	5MM, 33CM, LAP CLIP APPLICATOR, WECK MEDIUM, ROTATABLE, 3-PIECE DETACHABLE
52545-01C	5MM, 45CM LAP CLIP APPLIER FOR SMALL ETHICON CLIPS, 3-PIECE TAKE APART (FOR USE W/ 5.5MM SHEATH)
52545-02C	5MM, 45CM LAP CLIP APPLIER FOR MEDIUM ETHICON CLIPS, 3-PIECE TAKE APART (FOR USE W/ 6MM SHEATH)
52545-11C	5MM, 45CM LAP CLIP APPLIER FOR SMALL ELMED/PILLING WECK TITANIUM CLIPS, 3-PIECE TAKE APART (FOR USE W/ 5.5MM SHEATH)
52545-12C	5MM, 45CM LAP CLIP APPLIER FOR MEDIUM ELMED/PILLING WECK TITANIUM CLIPS, 3-PIECE TAKE APART (FOR USE W/ 6MM SHEATH)





ELMED LAPAROSCOPIC 10MM CLIP APPLIERS



MADE IN THE USA

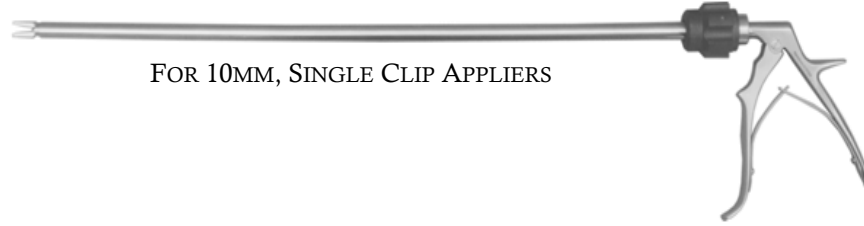

FOR 10MM, SINGLE CLIP APPLIERS

ETHICON ONE-PIECE STYLE

ITEM NO.	DESCRIPTION
52133-01	10MM, 33CM, LAP CLIP APPLICATOR, ETHICON SMALL, ROTATABLE, ONE-PIECE W/ FLUSHPORT
52133-02	10MM, 33CM, LAP CLIP APPLICATOR, ETHICON MEDIUM, ROTATABLE, ONE-PIECE W/ FLUSHPORT
52133-03	10MM, 33CM, LAP CLIP APPLICATOR, ETHICON MEDIUM-LARGE, ROTATABLE, ONE-PIECE W/ FLUSHPORT
52133-04	10MM, 33CM, LAP CLIP APPLICATOR, ETHICON, LARGE, ROTATABLE, ONE-PIECE W/ FLUSHPORT

HORIZON ONE-PIECE STYLE

ITEM NO.	DESCRIPTION
52133-41	10MM, 33CM, LAP CLIP APPLICATOR, HORIZON, SMALL, ROTATABLE, ONE-PIECE W/ FLUSHPORT
52133-42	10MM, 33CM, LAP CLIP APPLICATOR, HORIZON, MEDIUM, ROTATABLE, ONE-PIECE W/ FLUSHPORT
52133-43	10MM, 33CM, LAP CLIP APPLICATOR, HORIZON, MEDIUM-LARGE, ROTATABLE, ONE-PIECE W/ FLUSHPORT
52133-44	10MM, 33CM, LAP CLIP APPLICATOR, HORIZON, LARGE, ROTATABLE, ONE-PIECE W/ FLUSHPORT

WECK ONE-PIECE STYLE

ITEM NO.	DESCRIPTION
52133-21	10MM, 33CM, LAP CLIP APPLICATOR, WECK SMALL, ROTATABLE, ONE-PIECE W/ FLUSHPORT
52133-22	10MM, 33CM, LAP CLIP APPLICATOR, WECK, MEDIUM, ROTATABLE, ONE-PIECE W/ FLUSHPORT
52133-23	10MM, 33CM, LAP CLIP APPLICATOR, WECK MEDIUM-LARGE, ROTATABLE, ONE-PIECE W/ FLUSHPORT

3-PIECE MODULAR STYLE

ITEM NO.	DIA.	LENGTH	DESCRIPTION	INSERT ONLY	HANDLE ONLY	SHAFT ONLY
52133-01C	10MM	33CM	LAP CLIP APPLICATOR, ETHICON SMALL, ROTATABLE	52133-01I	52555-01	52133-00
52133-02C	10MM	33CM	LAP CLIP APPLICATOR, ETHICON MEDIUM, ROTATABLE	52133-02I	52555-01	52133-00
52133-03C	10MM	33CM	LAP CLIP APPLICATOR, ETHICON MEDIUM-LARGE, ROTATABLE	52133-03I	52555-01	52133-00
52133-04C	10MM	33CM	LAP CLIP APPLICATOR, ETHICON LARGE, ROTATABLE	52133-04I	52555-01	52133-00
52133-11C	10MM	33CM	LAP CLIP APPLICATOR, WECK SMALL, ROTATABLE	52133-11I	52555-01	52133-00
52133-12C	10MM	33CM	LAP CLIP APPLICATOR, ETHICON MEDIUM, ROTATABLE	52133-12I	52555-01	52133-00
52133-13C	10MM	33CM	LAP CLIP APPLICATOR, ETHICON MEDIUM-LARGE, ROTATABLE	52133-13I	52555-01	52133-00
52133-41C	10MM	33CM	LAP CLIP APPLICATOR, HORIZON, SMALL, ROTATABLE	52133-41I	52555-01	52133-00
52133-42C	10MM	33CM	LAP CLIP APPLICATOR, HORIZON, MEDIUM, ROTATABLE	52133-42I	52555-01	52133-00
52133-43C	10MM	33CM	LAP CLIP APPLICATOR, HORIZON, MEDIUM-LARGE, ROTATABLE	52133-43I	52555-01	52133-00
52525-84C	10MM	45CM	LAP CLIP APPLICATOR, ETHICON SMALL, ROTATABLE	52525-84I	52555-01	52133-01
52525-85C	10MM	45CM	LAP CLIP APPLICATOR, ETHICON MEDIUM, ROTATABLE	52525-85I	52555-01	52133-01
52525-86C	10MM	45CM	LAP CLIP APPLICATOR, ETHICON MEDIUM-LARGE, ROTATABLE	52525-86I	52555-01	52133-01
52525-87C	10MM	45CM	LAP CLIP APPLICATOR, ETHICON LARGE, ROTATABLE	52525-87I	52555-01	52133-01





ELMED LAPAROSCOPIC 5MM NEEDLE HOLDERS



MADE IN THE USA

TIP ID.	DIAMETER	LENGTH	52555-40-12	52555-40-19	52555-40-32
			 STAINLESS STEEL, RING AXIAL HANDLE W/RATCHET	 LIGHT WEIGHT AXIAL HANDLE, CURVED DOWN W/ RATCHET	 STRAIGHT AXIAL HANDLE SA W/ ON/OFF RATCHET
HANDLE OPTIONS					
STRAIGHT 8MM TC TIP 	5MM	33CM	52505-45	52505-70	52505-85
	5MM	36CM	52536-45	52536-70	52536-85
	5MM	45CM	52515-45	52515-70	52515-85
CURVED LEFT TC TIP 	5MM	33CM	52505-46	52505-71	52505-86
	5MM	36CM	52536-46	52536-71	52536-86
	5MM	45CM	52515-46	52515-71	52515-86
CURVED RIGHT TC TIP 	5MM	33CM	52505-47	52505-72	52505-87
	5MM	36CM	52536-47	52536-72	52536-87
	5MM	45CM	52515-47	52515-72	52515-87
OPEN SELF RIGHTING NEEDLE TIP 	5MM	33CM	52505-66	52505-73	52505-88
	5MM	36CM	52536-66	52536-73	52536-88
	5MM	45CM	52515-66	52515-73	52515-88
CLOSED SELF RIGHTING NEEDLE TIP 	5MM	33CM	52505-67	52505-74	52505-89
	5MM	36CM	52536-67	52536-74	52536-89
	5MM	45CM	52515-67	52515-74	52515-89





ELMED LAPAROSCOPIC 5MM NEEDLE HOLDERS



MADE IN THE USA

TIP ID.	DIAMETER	LENGTH	52555-40-20	52555-40-21	52555-40-26
			 STRAIGHT AXIAL HANDLE SA W/ ON/OFF RATCHET	 LIGHTWEIGHT STRAIGHT AXIAL HANDLE W/ RATCHET	 ALUMINUM AXIAL HANDLE, CURVED DOWN W/ RATCHET
HANDLE OPTIONS					
STRAIGHT 8MM TC TIP 	5MM	33CM		52505-77	52505-70P
	5MM	36CM		52536-77	52536-70P
	5MM	45CM		52515-77	52515-70P
CURVED LEFT TC TIP 	5MM	33CM		52505-78	52505-71P
	5MM	36CM		52536-78	52536-71P
	5MM	45CM		52515-78	52515-71P
CURVED RIGHT TC TIP 	5MM	33CM		52505-79	52505-72P
	5MM	36CM		52536-79	52536-72P
	5MM	45CM		52515-79	52515-72P
OPEN SELF RIGHTING NEEDLE TIP 	5MM	33CM		52505-82	52505-73P
	5MM	36CM		52536-82	52536-73P
	5MM	45CM		52515-82	52515-73P
CLOSED SELF RIGHTING NEEDLE TIP 	5MM	33CM		52505-83	52505-74P
	5MM	36CM		52536-83	52536-74P
	5MM	45CM		52515-83	52515-74P













ELMED LAPAROSCOPIC 5MM NEEDLE HOLDERS



MADE IN THE USA

TIP ID.	DIAMETER	LENGTH	52555-40-27	52555-40-13	
					
			HANDLE OPTIONS		
STRAIGHT 8MM TC TIP 	5MM	33CM	52505-85P	52505-60	
	5MM	36CM	52536-85P	52536-60	
	5MM	45CM	52515-85P	52515-60	
CURVED LEFT TC TIP 	5MM	33CM	52505-86P	52505-62	
	5MM	36CM	52536-86P	52536-62	
	5MM	45CM	52515-86P	52515-62	
CURVED RIGHT TC TIP 	5MM	33CM	52505-87P	52505-63	
	5MM	36CM	52536-87P	52536-63	
	5MM	45CM	52515-87P	52515-63	
OPEN SELF RIGHTING NEEDLE TIP 	5MM	33CM	52505-88P	52505-64	
	5MM	36CM	52536-88P	52536-64	
	5MM	45CM	52515-88P	52515-64	
CLOSED SELF RIGHTING NEEDLE TIP 	5MM	33CM	52505-74P	52505-89P	
	5MM	36CM	52536-74P	52536-89P	
	5MM	45CM	52515-74P	52515-89P	











ELMED MODULAR SCREW-APART LAPAROSCOPIC 5MM NEEDLE HOLDERS



MADE IN THE USA

TIP ID.	DIAMETER	LENGTH	INSERT NO.	52555-40-12	52555-40-19
				 STAINLESS STEEL, RING AXIAL HANDLE W/ RATCHET	 LIGHT WEIGHT AXIAL HANDLE, CURVED DOWN W/RATCHET
HANDLE OPTIONS					
STRAIGHT 8MM TC TIP 	5MM	33CM	52505-60I	52505-45C	52505-70C
	5MM	36CM	52536-60I	52536-45C	52536-70C
	5MM	45CM	52515-60I	52515-45C	52515-70C
CURVED LEFT TC TIP 	5MM	33CM	52505-62I	52505-46C	52505-71C
	5MM	36CM	52536-62I	52536-46C	52536-71C
	5MM	45CM	52515-62I	52515-46C	52515-71C
CURVED RIGHT TC TIP 	5MM	33CM	52505-63I	52505-47C	52505-72C
	5MM	36CM	52536-63I	52536-47C	52536-72C
	5MM	45CM	52515-63I	52515-47C	52515-72C
OPEN SELF RIGHTING NEEDLE TIP 	5MM	33CM	52505-64I	52505-66C	52505-73C
	5MM	36CM	52536-64I	52536-66C	52536-73C
	5MM	45CM	52515-64I	52515-66C	52515-73C
CLOSED SELF RIGHTING NEEDLE TIP 	5MM	33CM	52505-65I	52505-67C	52505-74C
	5MM	36CM	52536-65I	52536-67C	52536-74C
	5MM	45CM	52515-65I	52515-67C	52515-74C







ELMED MODULAR SCREW-APART LAPAROSCOPIC 5MM NEEDLE HOLDERS



MADE IN THE USA

TIP ID.	DIAMETER	LENGTH	INSERT NO.	52555-40-32	52555-40-13
					
				STRAIGHT AXIAL HANDLE SA W/ ON/OFF RATCHET	STRAIGHT AXIAL HANDLE SA W/ON/ OFF RATCHET
HANDLE OPTIONS					
STRAIGHT 8MM TC TIP 	5MM	33CM	52505-60I	52505-85C	
	5MM	36CM	52536-60I	52536-85C	
	5MM	45CM	52515-60I	52515-85C	
CURVED LEFT TC TIP 	5MM	33CM	52505-62I	52505-86C	
	5MM	36CM	52536-62I	52536-86C	
	5MM	45CM	52515-62I	52515-86C	
CURVED RIGHT TC TIP 	5MM	33CM	52505-63I	52505-87C	
	5MM	36CM	52536-63I	52536-87C	
	5MM	45CM	52515-63I	52515-87C	
OPEN SELF RIGHTING NEEDLE TIP 	5MM	33CM	52505-64I	52505-88C	
	5MM	36CM	52536-64I	52536-88C	
	5MM	45CM	52515-64I	52515-88C	
CLOSED SELF RIGHTING NEEDLE TIP 	5MM	33CM	52505-65I	52505-89C	
	5MM	36CM	52536-65I	52536-89C	
	5MM	45CM	52515-65I	52515-89C	





ELMED MODULAR SCREW-APART LAPAROSCOPIC 5MM NEEDLE HOLDERS



MADE IN THE USA

TIP ID.	DIAMETER	LENGTH	INSERT NO.	52555-40-22	52555-40-26
					
				LIGHTWEIGHT STRAIGHT AXIAL HANDLE W/ RATCHET	ALUMINUM AXIAL HANDLE, CURVED DOWN W/ RATCHET
HANDLE OPTIONS					
STRAIGHT 8MM TC TIP 	5MM	33CM	52505-60I	52505-77C	52505-70PC
	5MM	36CM	52536-60I	52536-77C	52536-70PC
	5MM	45CM	52515-60I	52515-77C	52515-70PC
CURVED LEFT TC TIP 	5MM	33CM	52505-62I	52505-78C	52505-71PC
	5MM	36CM	52536-62I	52536-78C	52536-71PC
	5MM	45CM	52515-62I	52515-78C	52515-71PC
CURVED RIGHT TC TIP 	5MM	33CM	52505-63I	52505-79C	52505-72PC
	5MM	36CM	52536-63I	52536-79C	52536-72PC
	5MM	45CM	52515-63I	52515-79C	52515-72PC
OPEN SELF RIGHTING NEEDLE TIP 	5MM	33CM	52505-64I	52505-82C	52505-73PC
	5MM	36CM	52536-64I	52536-82C	52536-73PC
	5MM	45CM	52515-64I	52515-82C	52515-73PC
CLOSED SELF RIGHTING NEEDLE TIP 	5MM	33CM	52505-65I	52505-83C	52505-74PC
	5MM	36CM	52536-65I	52536-83C	52536-74PC
	5MM	45CM	52515-65I	52515-83C	52515-74PC











ELMED MODULAR SCREW-APART LAPAROSCOPIC 5MM NEEDLE HOLDERS



MADE IN THE USA

TIP ID.	DIAMETER	LENGTH	INSERT NO.	52555-40-27	52555-40-13
				 ALUMINUM STRAIGHT AXIAL HANDLE SA W/ RATCHET	 STRAIGHT AXIAL HANDLE, DA W/ RATCHET
HANDLE OPTIONS					
STRAIGHT 8MM TC TIP 	5MM	33CM	52505-60I	52505-85PC	52505-60C
	5MM	36CM	52536-60I	52536-85PC	52536-60C
	5MM	45CM	52515-60I	52515-85PC	52515-60C
CURVED LEFT TC TIP 	5MM	33CM	52505-62I	52505-86PC	52505-62C
	5MM	36CM	52536-62I	52536-86PC	52536-62C
	5MM	45CM	52515-62I	52515-86PC	52515-62C
CURVED RIGHT TC TIP 	5MM	33CM	52505-63I	52505-87PC	52505-63C
	5MM	36CM	52536-63I	52536-87PC	52536-63C
	5MM	45CM	52515-63I	52515-87PC	52515-63C
OPEN SELF RIGHTING NEEDLE TIP 	5MM	33CM	52505-64I	52505-88PC	52505-64C
	5MM	36CM	52536-64I	52536-88PC	52536-64C
	5MM	45CM	52515-64I	52515-88PC	52515-64C
CLOSED SELF RIGHTING NEEDLE TIP 	5MM	33CM	52505-65I	52505-89PC	52505-65C
	5MM	36CM	52536-65I	52536-89PC	52536-65C
	5MM	45CM	52515-65I	52515-89PC	52515-65C











ELMED MODULAR SCREW-APART LAPAROSCOPIC 5MM NEEDLE HOLDERS



MADE IN THE USA

TIP ID.	DIAMETER	LENGTH	INSERT NO.	HANDLE OPTIONS
				
STRAIGHT 8MM TC TIP				
	5MM	33CM	52505-60I	
	5MM	36CM	52536-60I	
	5MM	45CM	52515-60I	
CURVED LEFT TC TIP				
	5MM	33CM	52505-62I	
	5MM	36CM	52536-62I	
	5MM	45CM	52515-62I	
CURVED RIGHT TC TIP				
	5MM	33CM	52505-63I	
	5MM	36CM	52536-63I	
	5MM	45CM	52515-63I	
OPEN SELF RIGHTING NEEDLE TIP				
	5MM	33CM	52505-64I	
	5MM	36CM	52536-64I	
	5MM	45CM	52515-64I	
CLOSED SELF RIGHTING NEEDLE TIP				
	5MM	33CM	52505-65I	
	5MM	36CM	52536-65I	
	5MM	45CM	52515-65I	





NEEDLE HOLDERS



MADE IN THE USA

ITEM NO.	DESCRIPTION
52505-19	5MM DIA., 32CM NEEDLE HOLDER ACCORDING TO DR. SEMM, SPRING SCISSOR HANDLE



ITEM NO.	DESCRIPTION
52515-95B10	5MM, 45CM LAP COMBINATION NEEDLE HOLDER/KNOT PUSHER, DOUBLE ACTION SLOTTED JAW W/ SERRATED LOWER JAW AND DIAMOND DUSTED UPPER JAW, 3.5MM WIDE AT TIP, INSULATED SHAFT, #10 CARBON FIBER HANDLE W/ ON-OFF LOCK, ROTATABLE ONE PIECE W/ FLUSH PORT





ELMED KNOT PUSHERS



MADE IN THE USA

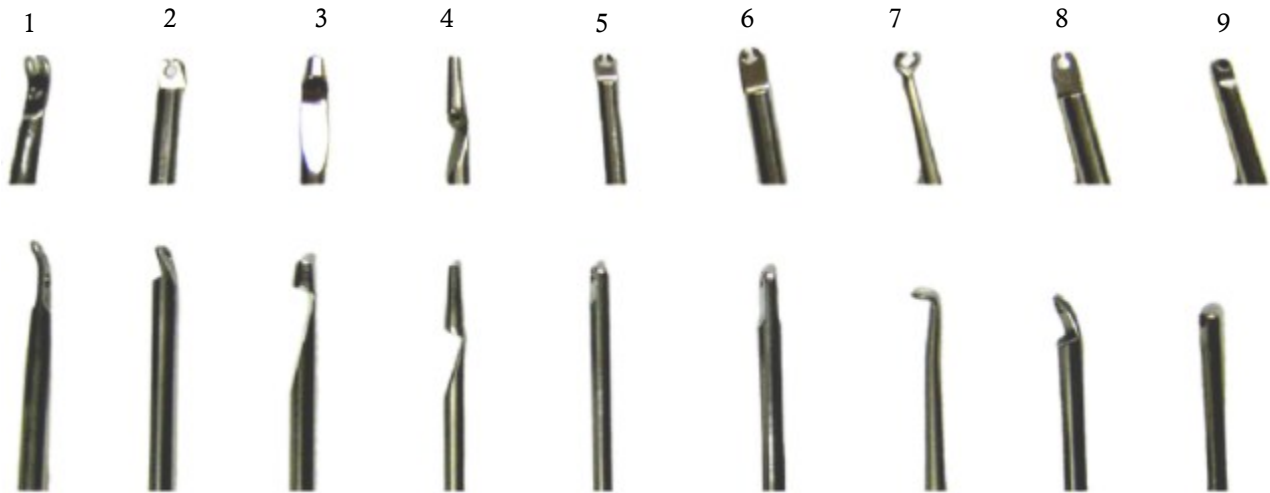

DESCRIPTION	ITEM NO. (33CM)	ITEM NO. (45CM)
ELMED KNOT PUSHER, STAINLESS STEEL 5MM DIA., STYLE 1	52205-61-01	52105-61-01
ELMED KNOT PUSHER, STAINLESS STEEL 5MM DIA., STYLE 2	52205-61-02	52105-61-02
ELMED KNOT PUSHER, STAINLESS STEEL 5MM DIA., STYLE 3	52205-61-03	52105-61-03
ELMED KNOT PUSHER, STAINLESS STEEL 5MM DIA., STYLE 4	52205-61-04	52105-61-04
ELMED KNOT PUSHER, STAINLESS STEEL 5MM DIA., STYLE 5	52205-61-05	52105-61-05
ELMED KNOT PUSHER, STAINLESS STEEL 5MM DIA., STYLE 6	52205-61-06	52105-61-06
ELMED KNOT PUSHER, STAINLESS STEEL 5MM DIA., STYLE 7	52205-61-07	52105-61-07
ELMED KNOT PUSHER, STAINLESS STEEL 5MM DIA., STYLE 8	52205-61-08	52105-61-08
ELMED KNOT PUSHER, STAINLESS STEEL 5MM DIA., STYLE 9	52205-61-09	52105-61-09
ELMED KNOT PUSHER, CLOSED, STAINLESS STEEL 5MM DIA., STYLE 1	52205-61-01C	52105-61-01C
ELMED KNOT PUSHER, CLOSED, STAINLESS STEEL 5MM DIA., STYLE 2	52205-61-02C	52105-61-02C
ELMED KNOT PUSHER, CLOSED, STAINLESS STEEL 5MM DIA., STYLE 5	52205-61-05C	52105-61-05C
ELMED KNOT PUSHER, CLOSED, STAINLESS STEEL 5MM DIA., STYLE 6	52205-61-06C	52105-61-06C
ELMED KNOT PUSHER, CLOSED, STAINLESS STEEL 5MM DIA., STYLE 7	52205-61-07C	52105-61-07C
ELMED KNOT PUSHER, CLOSED, STAINLESS STEEL 5MM DIA., STYLE 8	52205-61-08C	52105-61-08C





LAPAROSCOPIC SUTURE PASSER



MADE IN THE USA



*SPRING
HANDLE*



SYRINGE STYLE



PRECISION MICRO-POINTED AND POLISHED TIP WITH PLATFORM ON ALL OF SUTURE RETRIEVERS

52203-41	ELMED LAPAROSCOPIC TROCAR INCISION WOUND CLOSURE & HERNIA SUTURE RETRIEVER- 3.0MM DIA., 17CM WORKING LENGTH, SPRING HANDLE, CLEANING FLUSH PORT
52203-41C	ELMED LAPAROSCOPIC TROCAR INCISION WOUND CLOSURE & HERNIA SUTURE RETRIEVER- 3.0MM DIA., 17CM WORKING LENGTH, SPRING HANDLE, CLEANING FLUSH PORT (2-PIECE MODULAR)
52213-41	ELMED BARIATRIC LAPAROSCOPIC TROCAR INCISION WOUND CLOSURE & HERNIA SUTURE RETRIEVER- 3.0MM DIA., 20CM WORKING LENGTH, SPRING HANDLE, CLEANING FLUSH PORT
52213-41C	ELMED BARIATRIC LAPAROSCOPIC TROCAR INCISION WOUND CLOSURE & HERNIA SUTURE RETRIEVER- 3.0MM DIA., 20CM WORKING LENGTH, SPRING HANDLE, CLEANING FLUSH PORT (2-PIECE MODULAR)
52203-00	ELMED LAPAROSCOPIC TROCAR INCISION WOUND CLOSURE & HERNIA SUTURE RETRIEVER- 3.0MM DIA., 17CM WORKING LENGTH, SYRINGE HANDLE, CLEANING FLUSH PORT
52213-00	ELMED LAPAROSCOPIC TROCAR INCISION WOUND CLOSURE & HERNIA SUTURE RETRIEVER- 3.0MM DIA., 20CM WORKING LENGTH, SYRINGE HANDLE, CLEANING FLUSH PORT

STAINLESS STEEL TROCAR GUIDE CONES

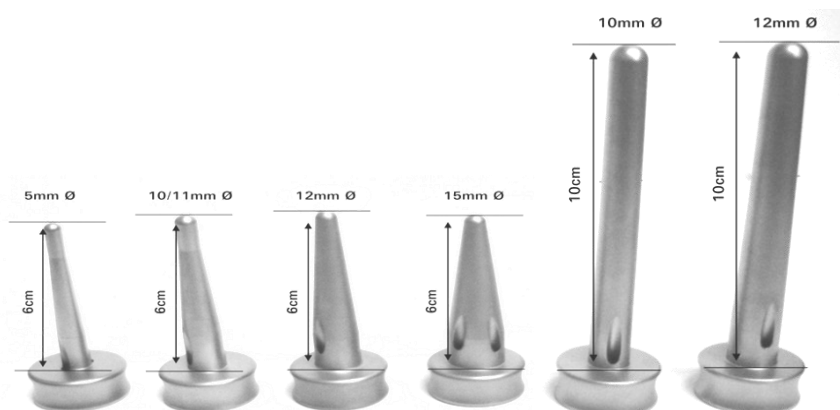

6CM LENGTH

52203-05	5MM DIAMETER
52203-10/11	10/11MM DIAMETER
52203-12	12MM DIAMETER
52203-15	15MM DIAMETER

10CM LENGTH

52204-05	5MM DIAMETER
52204-10/11	10/11MM DIAMETER
52204-12	12MM DIAMETER
52204-15	15MM DIAMETER





SPECIALTY *LAP* INSTRUMENTS

ELMED EXCELS IN BRINGING HIGH QUALITY INSTRUMENTATION AT VERY AFFORDABLE PRICING. OUR SPECIALTY LAP INSTRUMENTS FOLLOW THIS SAME MOTTO.



HASSON 3-PRONG GRASPER



MADE IN THE USA

THE ULTIMATE LAPAROSCOPIC INSTRUMENT FOR RETRACTION OF MYOMAS, FIBROIDS, OVARIES & OTHER ORGANS



52505-52

5MM, 32CM, 3-PRONG BULLDOG HASSON GRASPER AGGRESSIVE JAWS

52505-53

5MM, 32CM, 3-PRONG BULLDOG HASSON GRASPER CURVED ALLIS TEETH

52515-52

5MM, 45CM, 3-PRONG BULLDOG HASSON GRASPER AGGRESSIVE JAWS

52515-53

5MM, 45CM, 3-PRONG BULLDOG HASSON GRASPER CURVED ALLIS TEETH



52505-54

5MM, 32CM, 3-PRONG BULLDOG HASSON GRASPER STRAIGHT ALLIS TEETH

52505-55

5MM, 32CM, 3-PRONG HASSON GRASPER, BLUNT EDGED JAWS

52515-54

5MM, 45CM, 3-PRONG BULLDOG HASSON GRASPER STRAIGHT ALLIS TEETH

52515-55

5MM, 45CM, 3-PRONG HASSON GRASPER, BLUNT EDGED JAWS

MYOMA SCREW



Precision Machined Tip

SOLID STAINLESS STEEL CONSTRUCTION WITH PRECISION MACHINED TIP FOR PRECISE MANIPULATION AND SECURING OF THICK WALLED MYOMAS. COMPLETELY REUSABLE, HELPING REDUCE YOUR SPIRALING SURGICAL PROCEDURE COSTS.

52505-98

5MM Ø, 33CM WORKING LENGTH MYOMA SCREW

52505-99

10MM Ø, 33CM WORKING LENGTH MYOMA SCREW

52515-98

5MM Ø, 45CM WORKING LENGTH MYOMA SCREW

52515-99

10MM Ø, 45CM WORKING LENGTH MYOMA SCREW





CHOLANGIOGRAM CLAMP



MADE IN THE USA



52505-32	5MM Ø, 27CM WORKING LENGTH CHOLANGIOGRAM CLAMP
52505-33	5MM Ø, 32CM WORKING LENGTH CHOLANGIOGRAM CLAMP
52505-34	5MM Ø, 36CM WORKING LENGTH CHOLANGIOGRAM CLAMP
52505-35	5MM Ø, 45CM WORKING LENGTH CHOLANGIOGRAM CLAMP

****ALL 5MM DIAMETER,
4 DIFFERENT WORKING LENGTHS*

ENDOSCOPIC MAGNETIC ROD

STAINLESS STEEL CONSTRUCTION WITH SERRATED HANDLE FOR PRECISE
****IMPORTANT: INSTRUMENT TO BE USED ONLY UNDER DIRECT VISION****



52805-01	5MM Ø, 33CM LAPAROSCOPIC MAGNETIC ROD	52810-01	10MM Ø, 33CM LAPAROSCOPIC MAGNETIC ROD
52805-02	5MM Ø, 45CM LAPAROSCOPIC MAGNETIC ROD	52810-02	10MM Ø, 45CM LAPAROSCOPIC MAGNETIC ROD
52803-01	3MM Ø, 33CM LAPAROSCOPIC MAGNETIC ROD		
52803-02	3MM Ø, 45CM LAPAROSCOPIC MAGNETIC ROD		

RETRACTABLE ENDOSCOPIC KNIFE



52505-18	5MM, 36CM, RETRACTABLE ENDOSCOPIC KNIFE, W/ REPLACEABLE BEAVER BLADE
-----------------	--





ATRAUMATIC LONG JAW CHOLANGIOGRAM CLAMP



MADE IN THE USA

THE ELMED ATRAUMATIC LONG JAW CHOLANGIOGRAM CLAMP IS A VALUABLE INSTRUMENT USED IN LAPAROSCOPIC CHOLANGIOGRAPHY IN THE DETECTION OF DUCT STONES, VISUALIZATION OF DUCTAL ANOMALIES AND DISCOVERY AND PREVENTION OF INDUCED INJURIES TO THE BILE DUCTS.

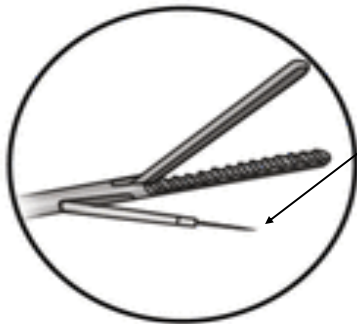
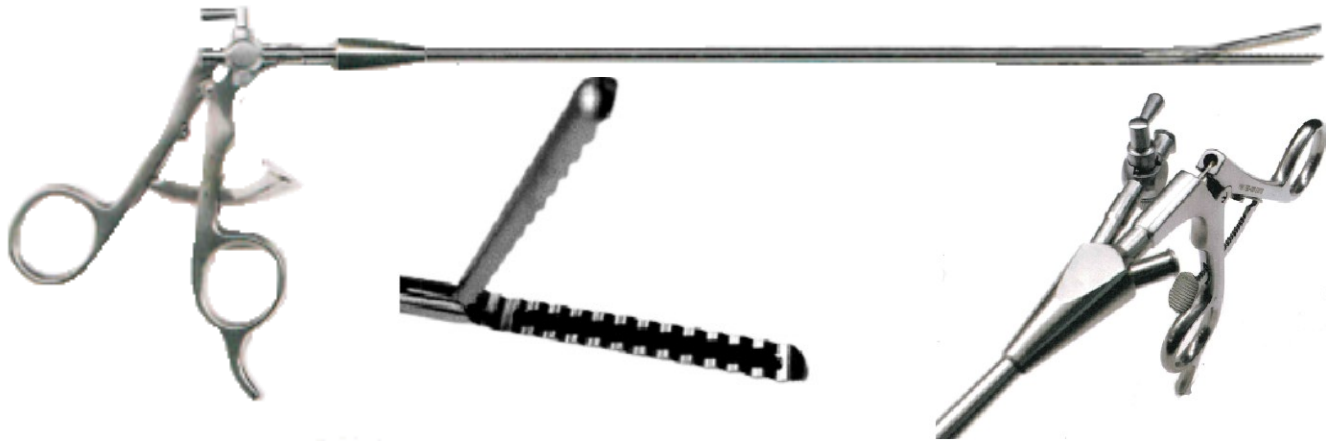

SHOWN 19 GAUGE (4.5 FR.) CATHETER WITH
22 NEEDLE

NOTE: INSIDE DIAMETER OF CATHETER
CHANNEL IS 16 GAUGE

ITEM No.	DIA.	WORKING LENGTH	DESCRIPTION
52505-41	5MM	33CM	ELMED ALJ CHOLANGIOGRAM CLAMP SINGLE ACTION 40MM ATRAUMATIC JAW CATHETER CHANNEL W/ STOPCOCK STAINLESS STEEL SHAFT & HANDLE WITH RATCHET RIGID ONE-PIECE WITH FLUSHPORT—AUTOCLAVABLE
52510-41	5MM	36CM	ELMED ALJ CHOLANGIOGRAM CLAMP SINGLE ACTION 40MM ATRAUMATIC JAW CATHETER CHANNEL W/ STOPCOCK STAINLESS STEEL SHAFT & HANDLE WITH RATCHET RIGID ONE-PIECE WITH FLUSHPORT—AUTOCLAVABLE
52515-41	5MM	45CM	ELMED ALJ CHOLANGIOGRAM CLAMP SINGLE ACTION 40MM ATRAUMATIC JAW CATHETER CHANNEL W/ STOPCOCK STAINLESS STEEL SHAFT & HANDLE WITH RATCHET RIGID ONE-PIECE WITH FLUSHPORT—AUTOCLAVABLE

AUTOCLAVABLE MEDICAL GRADE STAINLESS STEEL





SILASTIC RING APPLICATOR FOR TUBULAR STERILIZATION



MADE IN THE USA

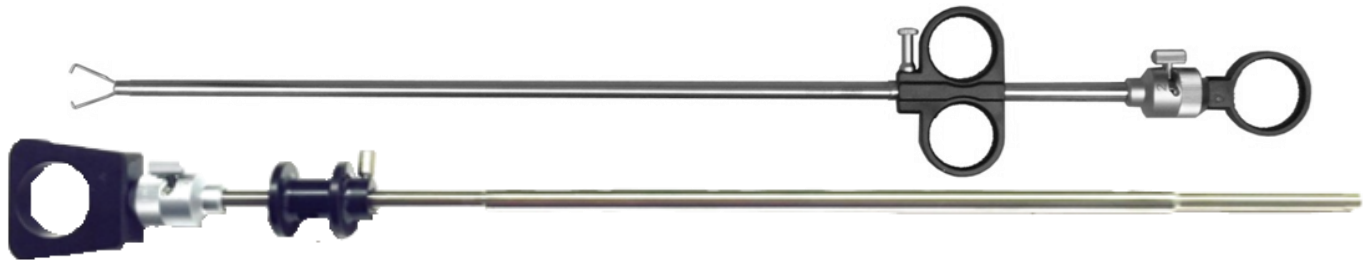

EXTENDED TIP



EXTENDED TIP
W/ (1) SILASTIC RING



EXTENDED TIP
W/ (2) SILASTIC RING

ITEM NO.	DESCRIPTION
52105-500	6MM Ø, 40CM SILASTIC RING APPLICATOR- FOR SINGLE AND DUAL RING APPLICATION; USE WITH OPERATING LAPAROSCOPE WITH 6MM Ø INSTRUMENT CHANNEL (SUGGEST ELMED ITEM NO. 52110-06).
52205-501	6 MM Ø, 33CM SILASTIC RING APPLICATOR FOR SINGLE AND DUAL RING APPLICATION; USE WITH LAPAROSCOPE AND 6MM Ø TROCAR SLEEVE (SEE ELMED DATA SHEET FOR APPROPRIATE SLEEVE).
52208-501	8MM Ø, 27CM SILASTIC RING APPLICATOR- FOR SINGLE AND DUAL RING APPLICATION; USE WITH LAPAROSCOPE AND 8MM Ø TROCAR SLEEVE (SEE ELMED DATA SHEET FOR APPROPRIATE SLEEVE). SAME DIAMETER AS ACMI
52208-500	8MM Ø, 33CM SILASTIC RING APPLICATOR- FOR SINGLE AND DUAL RING APPLICATION; USE WITH LAPAROSCOPE AND 8MM Ø TROCAR SLEEVE (SEE ELMED DATA SHEET FOR APPROPRIATE SLEEVE). SAME DIAMETER AS ACMI
52005-500	SILASTIC RING (PACKAGE OF 10) FOR TUBAL LIGATION NON-STERILE, AUTOCLAVABLE
52005-501	SILASTIC RING APPLICATOR AND GUIDE CONE SET (NOTE: (1) SET COMES WITH NEW INSTRUMENT)

COHEN CANNULA



ITEM NO.	DESCRIPTION
52001-13	COHEN CANNULA 2/ LARGE/SMALL REPLACEABLE TIPS
52001-19L	REPLACEMENT ACORN, LARGE, FOR 52001-13
52001-19s	REPLACEMENT ACORN, SMALL, FOR 52001-13
52001-13W	COHEN CANNULA WITH LARGE/SMALL REPLACEABLE TIPS-SLOTTED HANDLE-WOLF STYLE
52001-29	3MM CLEANING BRUSH FOR FRONT TUBE OF COHEN CANNULA (QTY 12/PACK)
52001-31	5MM CLEANING BRUSH FOR REAR TUBE OF COHEN CANNULA (QTY 12/PACK)

ITEM NO.	DESCRIPTION
52001-12s	COHEN CANNULA WITH FIXED SMALL STAINLESS STEEL ACORN
52001-12L	COHEN CANNULA WITH FIXED LARGE STAINLESS STEEL ACORN
52001-29	3MM CLEANING BRUSH FOR FRONT TUBE OF COHEN CANNULA (QTY 12/PACK)
52001-31	5MM CLEANING BRUSH FOR REAR TUBE OF COHEN CANNULA (QTY 12/PACK)



UTERINE MANIPULATOR



MADE IN THE USA

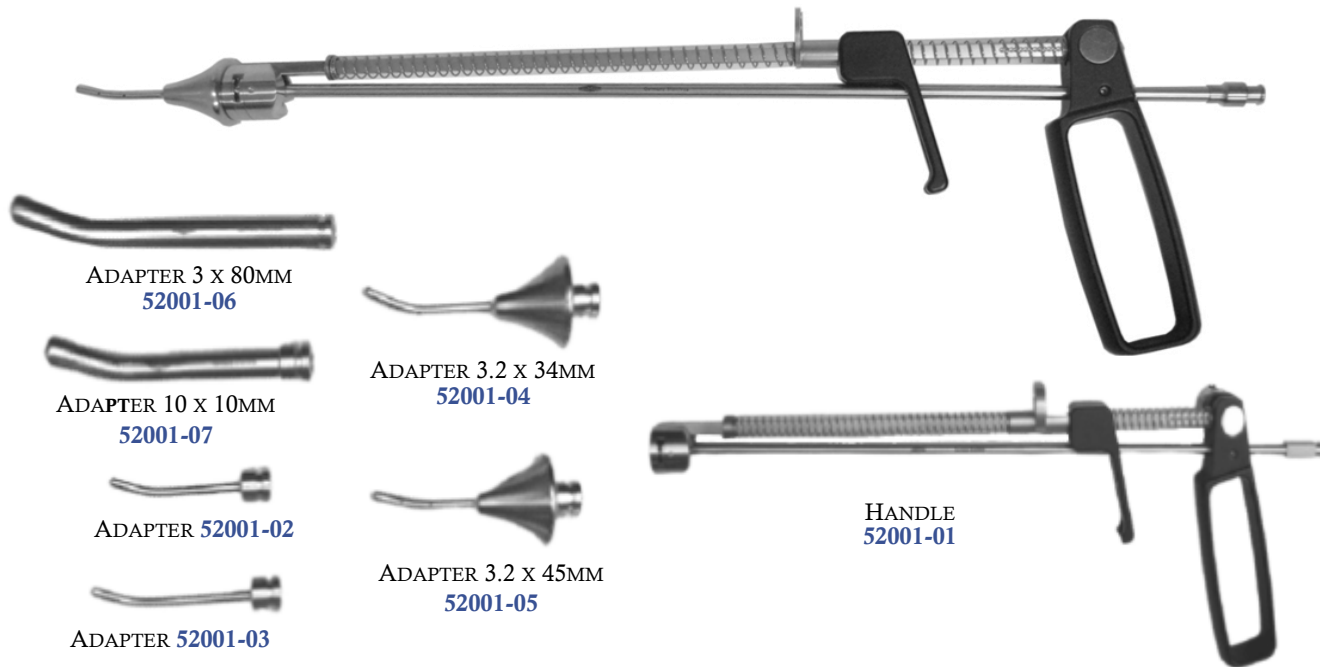

ADAPTER 3 x 80MM
52001-06

ADAPTER 10 x 10MM
52001-07

ADAPTER 52001-02

ADAPTER 52001-03



ADAPTER 3.2 x 34MM
52001-04



ADAPTER 3.2 x 45MM
52001-05

HANDLE
52001-01

52001-00

ELMED V/T (VALTEHER/PELOSI) UTERINE MANIPULATOR: COMPLETE W/ SET OF (6) INTERCHANGEABLE OBTURATORS & CANNULA

VALTCHEV UTERINE MOBILIZER



52001-00-6

ELEMED VALTCHEV UTERINE MOBILIZER SET: INCLUDES VALTCHEV UTERINE MOBILIZER, 2 CANNULAS OF DIFFERENT SIZE & 4 OBTURATORS OF DIFFERENT SIZE



UTERINE TENACULA



MADE IN THE USA



52001-09 | HULKA UTERINE MANIPULATOR
TENACULUM



52001-16 | BEHRMAN UTERINE MANIPULATOR
TENACULUM



52001-14 | SCHROEDER TENACULUM SINGLE
TOOTH (9 1/2")



52001-08 | SCHROEDER VULSELLUM DOUBLE
TOOTH (9 1/2")



52001-18 | SARGIS UTERINE GRASPING FORCEPS (9
1/2")



52001-17 | GIMPELSON CERVICAL SEALING
TENACULUM (9 1/2")



ASPIRATION NEEDLES



MADE IN THE USA

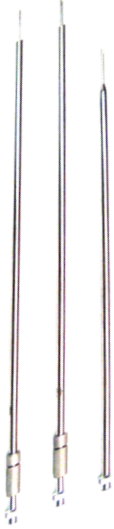

ITEM NO.	DESCRIPTION
52103-19	3MM, 45CM INJECTION, ASPIRATION, & BIOPSY NEEDLE
52105-27	5MM, 45CM ASPIRATION NEEDLE, 15 GA. NEEDLE SIZE- STANDARD (18 GA TO 25 GA AVAILABLE-PLEASE SPECIFY)
52105-27R	5MM, 45CM RETRACTABLE ASPIRATION NEEDLE, 15 GA. NEEDLE SIZE-STANDARD (18 GA. TO 25 GA. AVAILABLE - PLEASE SPECIFY)
52105-27W	5MM DIA., 45CM ASPIRATION NEEDLE, WITH ANGLED 45° TUBE, 15 GA. NEEDLE SIZE - STANDARD (18 GA. TO 25 GA. AVAILABLE - PLEASE SPECIFY)
52203-22	3MM DIA., 33CM INJECTION, ASPIRATION AND BIOPSY NEEDLE
52205-31	5MM DIA., 33CM ASPIRATION NEEDLE 15 GA. NEEDLE SIZE - STANDARD (18 GA. TO 25 GA. AVAILABLE- PLEASE SPECIFY)
52205-31R	5MM DIA., 33CM RETRACTABLE ASPIRATION NEEDLE 15 GA. NEEDLE SIZE - STANDARD (18 GA. TO 25 GA. AVAILABLE- PLEASE SPECIFY)

VERESS NEEDLES



ITEM NO.	DESCRIPTION	ITEM NO.	DESCRIPTION
52003-07	2MM DIA., 260MM (10") VERESS INSUFFLATION NEEDLE	52003-10	2MM DIA., 100MM (4") VERESS INSUFFLATION NEEDLE
52003-08	2MM DIA., 180MM (7") VERESS INSUFFLATION NEEDLE	52003-11	2MM DIA., 120MM (5") VERESS INSUFFLATION NEEDLE
52003-09	2MM DIA., 55MM (2") VERESS INSUFFLATION NEEDLE	52003-12	2MM DIA., 150MM (6") VERESS INSUFFLATION NEEDLE

PALPATION TACTILE PROBES W/ CM MARKINGS



ITEM NO.	DESCRIPTION
52205-29	5MM, 33CM, PALPATION TACTILE PROBE W/ CM MARKING
52105-25	5MM, 45CM, PALPATION TACTILE PROBE W/ CM MARKING
52133-25	10MM, 33CM, PALPATION TACTILE PROBE W/ CM MARKING
52145-25	10MM, 45CM, PALPATION TACTILE PROBE W/ CM MARKING





SPECIALTY CANNULAS



MADE IN THE USA



ITEM No.	DESCRIPTION
52103-130	3MM Ø, 45CM REUSABLE STAINLESS STEEL CANNULA & OBTURATOR SET. CONSISTING OF: (1) OUTER CANNULA 3MM Ø, 45CM WITH HANDLE & LUER LOCK FITTING (A) (2) OBTURATOR 2.2MM Ø X 47CM WITH HANDLE & ROUND TIP (B)
52205-130	5MM Ø, 30CM REUSABLE STAINLESS STEEL CANNULA & OBTURATOR SET. CONSISTING OF:: (1) OUTER CANNULA 5MM Ø, 30CM WITH HANDLE & LUER LOCK FITTING (A) (2) OBTURATOR 3.8MM Ø X 32CM WITH HANDLE & ROUND TIP (B)
52105-130	5MM Ø, 45CM REUSABLE STAINLESS STEEL CANNULA & OBTURATOR SET. CONSISTING OF:: (1) OUTER CANNULA 5MM Ø, 45CM WITH HANDLE & LUER LOCK FITTING (A) (2) OBTURATOR 3.8MM Ø X 47CM WITH HANDLE & ROUND TIP (B)
52203-130	3MM Ø, 30CM REUSABLE STAINLESS STEEL CANNULA & OBTURATOR SET. CONSISTING OF:: (1) OUTER CANNULA 3MM Ø, 30CM WITH HANDLE & LUER LOCK FITTING (A) (2) OBTURATOR 2.2MM Ø X 32CM WITH HANDLE & ROUND TIP (B)
52103-130	3MM Ø, 45CM REUSABLE STAINLESS STEEL CANNULA & OBTURATOR SET. CONSISTING OF:: (1) OUTER CANNULA 3MM Ø, 45CM WITH HANDLE & LUER LOCK FITTING (A) (2) OBTURATOR 32.2MM Ø X 47CM WITH HANDLE & ROUND TIP (B)

HANDLES

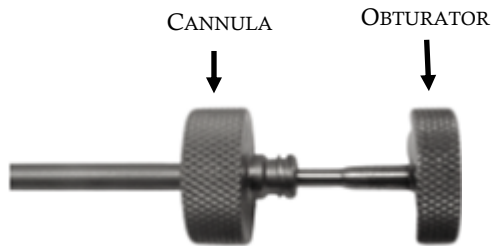

TIPS—CANNULA & OBTURATOR





SPECIALTY CANNULAS



MADE IN THE USA

ITEM NO.	DESCRIPTION
52367-02	FRANKENHEIM 2.5MM INSTRUMENT SET FOR SECOND PUNCTURE. COMPLETE SET

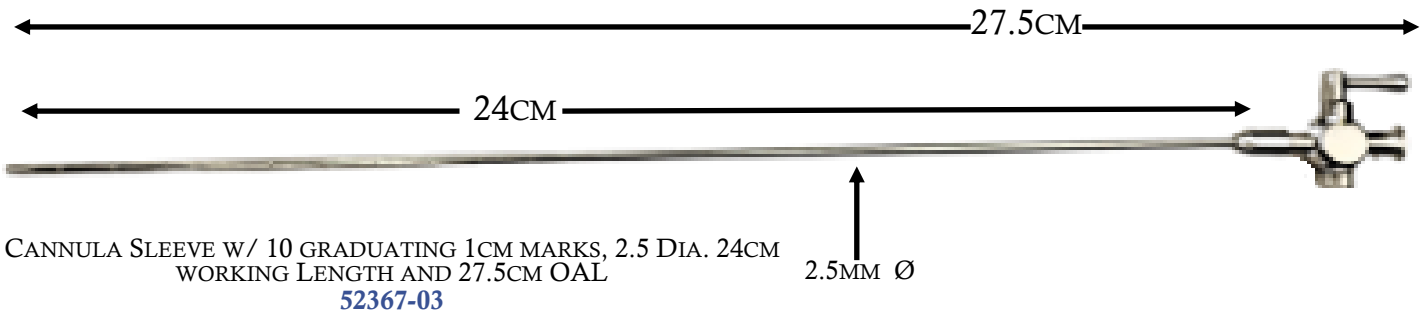

1CM MARKING
"GRADUATING" CM
MARKS



PYRAMID TIP
52367-12



BLUNT TIP
52367-20





SELF-RETAINING RETRACTOR SYSTEMS & MINIMAL INVASIVE RETRACTORS

ELMED RETRACT-ROBOT, THE COMPLETE MECHANICAL RETRACTOR SYSTEM:

THE MOST VERSATILE INSTRUMENT IN YOUR O.R., FOR USE IN LAPAROSCOPY AS A SCOPE HOLDER OR LIVER RETRACTOR, IN THORACIC, CARDIOVASCULAR & OPEN SURGERY, AS CHEST CAVITY AND BOWEL RETRACTOR, ETC.

WE ALSO OFFER A FULL RANGE OF LAPAROSCOPIC RETRACTORS.



ELMED RETRACT ROBOT IN LAPAROSCOPIC SURGERY



MADE IN THE USA

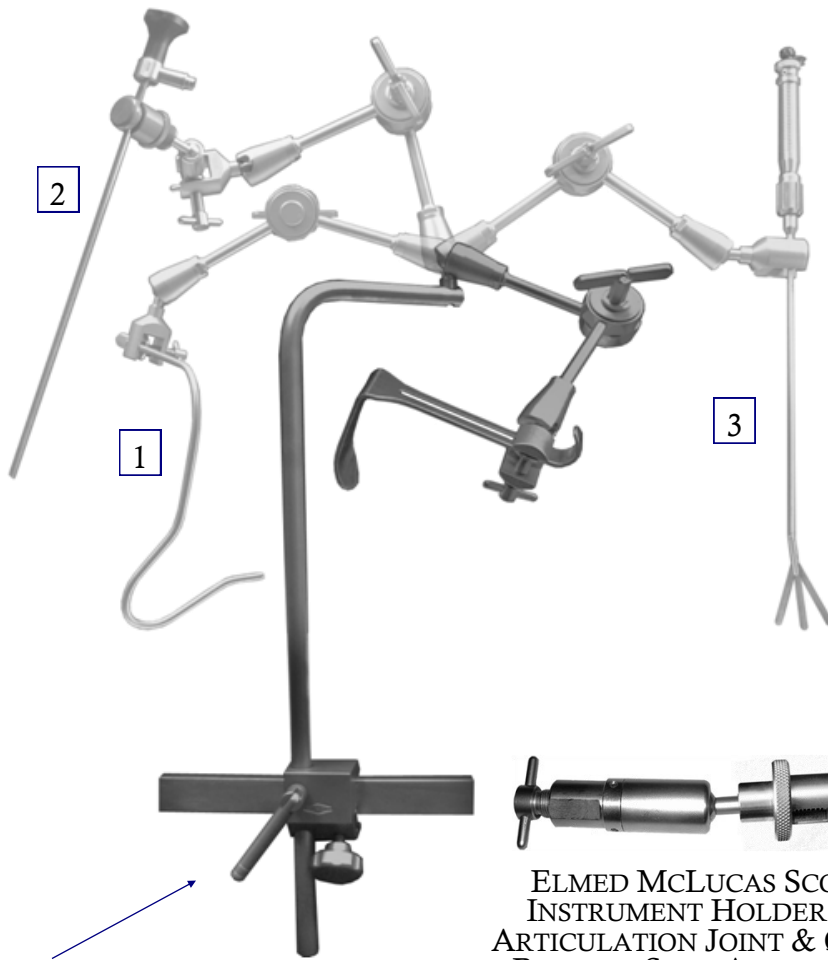

VARIOUS INSTRUMENTS SHOWN WITH THE SINGLE-ARM RETRACT-ROBOT:

- 1) WITH THE NATHANSON LIVER RETRACTOR
- 2) WITH THE ARTICULATING SCOPE HOLDER: QUICK, STABLE & PRECISE ADJUSTMENT CAN BE MADE WITH THE TURN OF A KNOB.
- 3) WITH THE FAN RETRACTOR; ANY TYPE OF RETRACTOR CAN BE HELD IN A STABLE, FULLY ADJUSTABLE POSITION AT MAXIMUM RETRACTION, E.G. FLAT, ROUND, ETC.

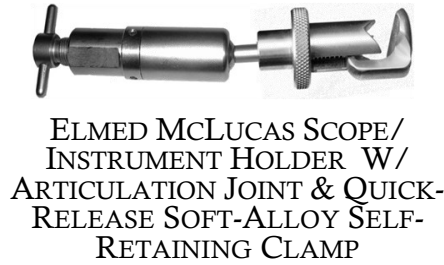

ELMED MCLUCAS SCOPE/
INSTRUMENT HOLDER W/
ARTICULATION JOINT & QUICK-
RELEASE SOFT-ALLOY SELF-
RETAINING CLAMP



ELMED EXTENSION CLAMP FOR
BARIATRIC SURGERY (FITS INTO
STERILE-CLAMP)

THE ELMED STERIL-CLAMP:
PROVIDE SAFE AND STABLE
MOUNTING IN STERILE CONDITION
ON TOP OF THE DRAPE ON ANY
OPERATING TABLE RAIL

ITEM NO.	DESCRIPTION
15088-00	ELMED RETRACT-ROBOT SINGLE ARM INSTRUMENT
15088-01	ELMED RETRACT-ROBOT SINGLE ARM INSTRUMENT W/ EXTRA-LONG MOUNTING ROD (26") (BARIATRIC)
15090-53	ELMED STERIL-CLAMP HEAVY DUTY, 5/8" ROUND HOLE OR 1/2" X 1" SLOT (FOR EXTRA LONG ROBOT ARM)
15090-56	ELMED STERIL-CLAMP STANDARD, AUTOCLAVABLE W/ ROUND 5/8" ACCESSORY OPENING
15090-57	ELMED EXTENSION CLAMP FOR BARIATRIC SURGERY: AUTOCLAVABLE, 5/8" ACCESSORY OPENING
52410-01	ELMED SCOPE/INSTRUMENT HOLDER W/ ARTICULATION JOINT SELF-RETAINING CLAMP (SLEEVE STYLE)
52400-00	ELMED ENDOSCOPIC FIXATION DEVICE CONSISTING OF: ITEM NO'S: 15088-00 , 15090-56 , & 52410-01
52400-01	ELMED BARIATRIC ENDOSCOPIC FIXATION DEVICE CONSISTING OF ITEM NO'S: 15088-01 , 15090-53 , & 52410-01



ELMED GOOSE NECK RETRACTOR IN LAPAROSCOPIC SURGERY



MADE IN THE USA

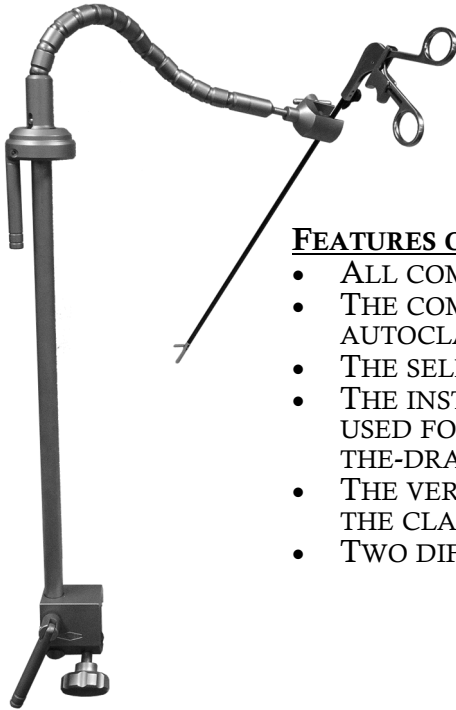

FEATURES OF THE GOOSE-NECK SYSTEM:

- ALL COMPONENTS ARE MADE OF A HIGH GRADE STAINLESS STEEL.
- THE COMPLETE SYSTEM, INCLUDING THE STERIL-CLAMP™, MAY BE FLASH AUTOCLAVED
- THE SELF-RETAINING JOINTS ROTATE & TWIST IN EVERY DESIRABLE POSITION
- THE INSTRUMENT SHAFT FITS INTO TABLE ACCESSORY CLAMPS SUCH AS THOSE USED FOR STIRRUPS & LEG HOLDERS, AS WELL AS ALL OF THE OTHER OVER-THE-DRAPE CLAMPS WITH AN OPENING OF 5/8"
- THE VERTICAL SHAFT (5/8") MAY BE LOWERED OR HEIGHTENED WITHIN THE CLAMP FOR FLEXIBLE ADJUSTMENT
- TWO DIFFERENT MODELS WITH DIFFERENT INSTRUMENT HOLDERS AVAILABLE

ITEM No.	DESCRIPTION
15090-60	ELMED GOOSE-NECK RETRACTOR SYSTEM WITH SELF-RETAINING SLEEVE CLAMP WITH ARTICULATING JOINT FOR HOLDING TELESCOPE INCLUDES 15090-56: STERIL-CLAMP™ FOR ATTACHING TO TABLE
15090-61	ELMED GOOSE-NECK RETRACTOR SYSTEM WITH UNIVERSAL MOUNTING CLAMP FOR HOLDING ALL TYPES OF INSTRUMENTS INCLUDES 15090-56: STERIL-CLAMP™ FOR ATTACHING TO TABLE

RETRACT ROBOT & GOOSE NECK RETRACTOR STERILIZATION CONTAINERS

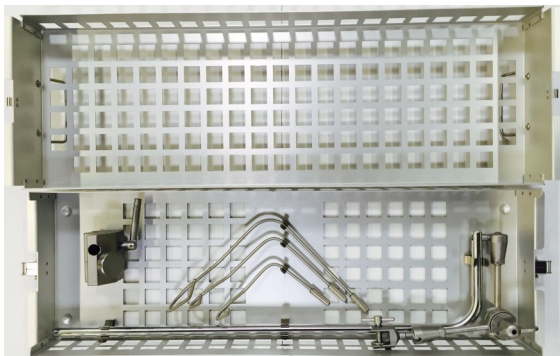

ITEM No.	DESCRIPTION
55040-03	ELMED ALUMINUM STORAGE/STERILIZATION CONTAINER W/ PERFORATED LID & BOTTOM, W/ BRACKETS FOR MOUNTING RETRACT-ROBOT #15088-00 & #15090-53 OR 15090-56. (FOR WRAPPING) DIMENSIONS: 26"L X 10"W X 7"H (63.5CM X 25CM X 13CM).
55040-02	ELMED ALUMINUM STORAGE/STERILIZATION CONTAINER W/ PERFORATED LID & BOTTOM, W/ BRACKETS FOR MOUNTING RETRACT-ROBOT #15088-01 OR 15088-03 & STERIL-CLAMP #15090-53 OR 15090-56. (FOR WRAPPING.) DIMENSIONS: 30"L X 10"W X 6"H (76CM X 25CM X 15CM).





NATHANSON LIVER RETRACTORS



MADE IN THE USA

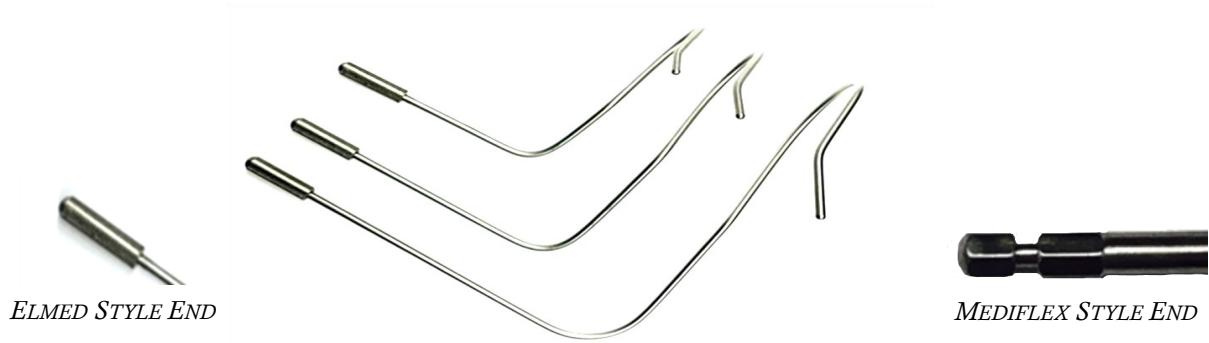

ELMED STYLE END

MEDIFLEX STYLE END

ITEM NO.	DESCRIPTION	ITEM NO.
52420-00	ELMED NATHANSON STYLE LIVER RETRACTORS 6.5MM DIA. SET OF 3 - SIZES: SMALL MEDIUM LARGE	52440-00
52420-01	ELMED NATHANSON STYLE LIVER RETRACTORS 6.5MM DIA.- SMALL	52440-01
52420-02	ELMED NATHANSON STYLE LIVER RETRACTORS 6.5MM DIA.- MEDIUM	52440-02
52420-03	ELMED NATHANSON STYLE LIVER RETRACTORS 6.5MM DIA.- LARGE	52440-03
52430-00	ELMED NATHANSON STYLE LIVER RETRACTORS 5MM DIA. SET OF 3 - SIZES: SMALL MEDIUM LARGE	52450-00
52430-01	ELMED NATHANSON STYLE LIVER RETRACTORS 5MM DIA.- SMALL	52450-01
52430-02	ELMED NATHANSON STYLE LIVER RETRACTORS 5MM DIA.- MEDIUM	52450-02
52430-03	ELMED NATHANSON STYLE LIVER RETRACTORS 5MM DIA.- LARGE	52450-03
52430-04	ELMED NATHANSON STYLE LIVER RETRACTORS 5MM DIA.- X-SMALL	52450-04
52430-05	ELMED NATHANSON STYLE LIVER RETRACTORS 5MM DIA.- X-LARGE	
52460-00	ELMED NATHANSON STYLE LIVER RETRACTORS 3.0MM DIA. SET OF 3 - SIZES: SMALL MEDIUM LARGE	52460-00
52460-03	ELMED NATHANSON STYLE LIVER RETRACTORS 3.0MM DIA.- SMALL	52460-01
52460-04	ELMED NATHANSON STYLE LIVER RETRACTORS 3.0MM DIA.- MEDIUM	52460-02
52460-05	ELMED NATHANSON STYLE LIVER RETRACTORS 3.0MM DIA.- LARGE	52460-03
52460-06	ELMED NATHANSON STYLE LIVER RETRACTORS 3.0MM DIA.- X-SMALL	52460-04





NATHANSON LIVER RETRACTORS



MADE IN THE USA

COOK STYLE NATHANSON LIVER RETRACTORS*



FISCHER STYLE LIVER RETRACTORS



ITEM NO.	DESCRIPTION
52420-05	6.5MM, NATHANSON RETRACTOR-COOK STYLE, LARGE, 75MM
52420-06	6.5MM, NATHANSON RETRACTOR-COOK STYLE, X-LARGE, 95MM

ITEM NO.	DESCRIPTION
52460-01	ELMED FISHER STYLE LIVER RETRACTORS, 5MM DIA.
52460-02	ELMED FISHER STYLE LIVER RETRACTORS, 10MM DIA.

SPECULUM RETRACTOR—3 BLADES FOR GALL BLADDER EXTRACTION*

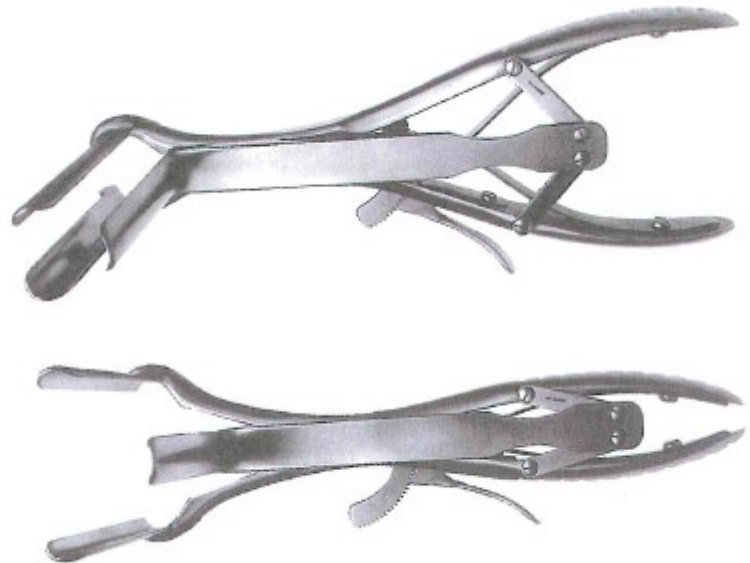
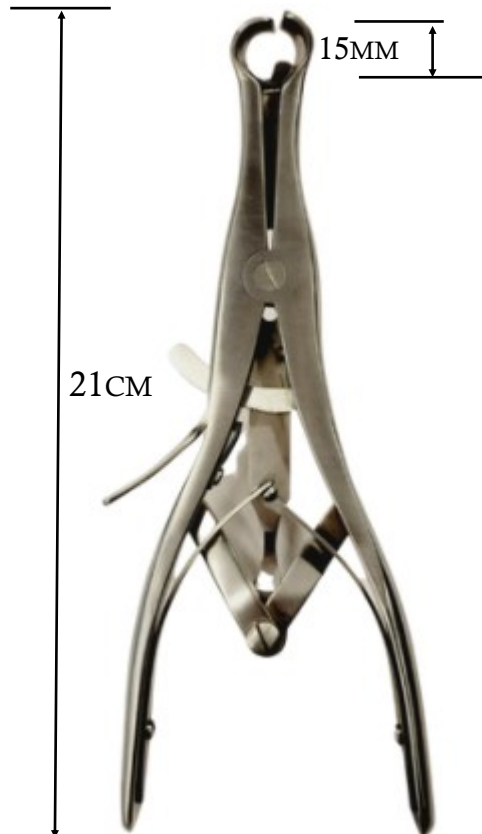

ITEM NO.	DESCRIPTION **
52511-00	ELMED SPECULUM RETRACTOR 3-BLADES FOR GALL BLADDER EXTRACTION 15MM DIA. CLOSED 45MM MAX. OPEN FOR USE WITH 11 MM . PLUS TROCAR SLEEVE





NATHANSON LIVER RETRACTORS FOR ROBOTIC USE



MADE IN THE USA



ITEM NO.	DESCRIPTION
52409-00	SET OF 6.5MM NATHANSON RETRACTORS, ROBOTIC SHAFT 9CM: SMALL, MEDIUM, LARGE
52409-01	SMALL 6.5MM NATHANSON RETRACTOR, ROBOTIC SHAFT 9CM
52409-02	MEDIUM 6.5MM NATHANSON RETRACTOR, ROBOTIC SHAFT 9CM
52409-03	LARGE, 6.5MM, ROBOTIC SHAFT 9CM
52409-04	SET OF 5.0MM NATHANSON RETRACTORS, ROBOTIC SHAFT 9CM: SMALL, MEDIUM, LARGE
52409-05	SMALL 5.0MM NATHANSON RETRACTOR, ROBOTIC SHAFT 9CM
52409-06	MEDIUM 5.0MM NATHANSON RETRACTOR, ROBOTIC SHAFT 9CM
52409-07	LARGE 5.0MM NATHANSON RETRACTOR, ROBOTIC SHAFT 9CM
52412-00	SET OF 6.5MM NATHANSON RETRACTORS, ROBOTIC SHAFT 12CM: SMALL, MEDIUM, LARGE
52412-01	SMALL 6.5MM NATHANSON RETRACTOR, ROBOTIC SHAFT 12CM
52412-02	MEDIUM 6.5MM NATHANSON RETRACTOR, ROBOTIC SHAFT 12CM
52412-03	LARGE 6.5MM NATHANSON RETRACTOR, ROBOTIC SHAFT 12CM
52450-00	SET OF 5.0MM NATHANSON HOOKS: SMALL, MEDIUM, LARGE
52450-01	SMALL 5.0MM NATHANSON RETRACTOR
52450-02	MEDIUM 5.0MM NATHANSON RETRACTOR
52450-03	LARGE 5.0MM NATHANSON RETRACTOR
52450-04	EXTRA SMALL 5.0MM NATHANSON RETRACTOR
52440-00	SET OF 6.5MM NATHANSON HOOKS: SMALL, MEDIUM, LARGE
52440-01	SMALL 6.5MM NATHANSON RETRACTOR
52440-02	MEDIUM 6.5MM NATHANSON RETRACTOR
52440-03	LARGE, 6.5MM NATHANSON RETRACTOR, LONG TIP, ROBOTIC SHAFT 9CM



TO ORDER CALL: (224) 353-6446



90° ARTICULATING FLAT BLADE RETRACTORS



MADE IN THE USA

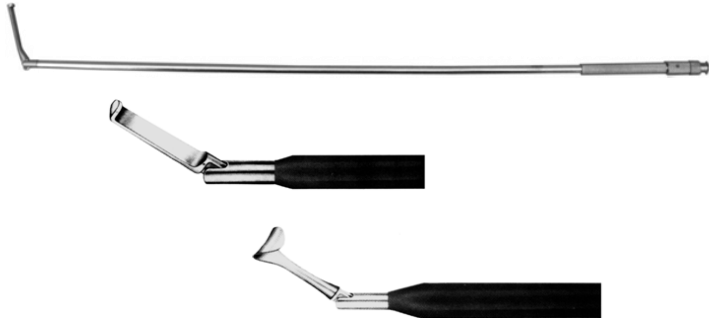

ITEM NO.	DESCRIPTION
52505-48	5MM Ø, 33CM RETRACTOR; 90° ARTICULATING FLAT BLADE, WITH FLUSH PORT
52515-48	5MM Ø, 45CM RETRACTOR; 90° ARTICULATING FLAT BLADE, WITH FLUSH PORT
52510-87	10MM Ø, 33CM RETRACTOR; 90° ARTICULATING FLAT BLADE, WITH FLUSH PORT
52511-87	10MM Ø, 45CM RETRACTOR; 90° ARTICULATING FLAT BLADE, WITH FLUSH PORT
52510-86	10MM Ø, 33CM RETRACTOR; 90° ARTICULATING "CUSHING"-TYPE BLADE, WITH FLUSH PORT
52511-86	10MM Ø, 45CM RETRACTOR; 90° ARTICULATING "CUSHING"-TYPE BLADE, WITH FLUSH PORT

LAP BANDING RETRACTORS



REAR CONTROL KNOB



ITEM NO.	DESCRIPTION
52525-21	5MM DIA., 36CM, ESOPHAGEAL RETRACTOR FOR APPLICATION GASTRIC BANDING 90° ARTICULATING, DISTAL TIP, FLUSH PORT REAR CONTROL KNOB
52515-21	10MM DIA., 36CM, ESOPHAGEAL RETRACTOR FOR APPLICATION GASTRIC BANDING 90° ARTICULATING, DISTAL TIP, FLUSH PORT REAR CONTROL KNOB
52525-30	5MM DIA., 41CM, ESOPHAGEAL RETRACTOR FOR APPLICATION GASTRIC BANDING 90° ARTICULATING, DISTAL TIP, FLUSH PORT REAR CONTROL KNOB
52515-30	10MM DIA., 41CM, ESOPHAGEAL RETRACTOR FOR APPLICATION GASTRIC BANDING 90° ARTICULATING, DISTAL TIP, FLUSH PORT REAR CONTROL KNOB
52525-31	5MM DIA., 36CM, ESOPHAGEAL RETRACTOR FOR APPLICATION GASTRIC BANDING 90° ARTICULATING, DISTAL TIP, FLUSH PORT FRONT CONTROL KNOB
52515-31	10MM DIA., 36CM, ESOPHAGEAL RETRACTOR FOR APPLICATION GASTRIC BANDING 90° ARTICULATING, DISTAL TIP, FLUSH PORT FRONT CONTROL KNOB
52525-32	5MM DIA., 41CM, ESOPHAGEAL RETRACTOR FOR APPLICATION GASTRIC BANDING 90° ARTICULATING, DISTAL TIP, FLUSH PORT FRONT CONTROL KNOB
52515-32	10MM DIA., 41CM, ESOPHAGEAL RETRACTOR FOR APPLICATION GASTRIC BANDING 90° ARTICULATING, DISTAL TIP, FLUSH PORT FRONT CONTROL KNOB



LAP BANDING RETRACTORS W/ RATCHET HANDLE



MADE IN THE USA



ITEM NO.	DESCRIPTION	ITEM NO.	DESCRIPTION
52525-21A4	5MM DIA., 36CM, ESOPHAGEAL RETRACTOR-GASTRIC BAND MANIPULATOR, 90°, ANGULATION, WITH RING RATCHET HANDLE, RIGID, ONE PIECE W/FLUSH PORT	52525-21B4	5MM DIA., 36CM, ESOPHAGEAL RETRACTOR-GASTRIC BAND MANIPULATOR, 90°, ANGULATION, WITH RING RATCHET HANDLE, ROTATABLE- ONE PIECE W/ FLUSH PORT
52515-21A4	5MM DIA., 41CM, ESOPHAGEAL RETRACTOR-GASTRIC BAND MANIPULATOR, 90°, ANGULATION, WITH RING RATCHET HANDLE, RIGID, ONE PIECE W/FLUSH PORT	52515-21B4	5MM DIA., 41CM, ESOPHAGEAL RETRACTOR-GASTRIC BAND MANIPULATOR, 90°, ANGULATION, WITH RING RATCHET HANDLE, ROTATABLE- ONE PIECE W/ FLUSH PORT
52525-30A4	10MM DIA., 36CM, ESOPHAGEAL RETRACTOR-GASTRIC BAND MANIPULATOR, 90°, ANGULATION, WITH RING RATCHET HANDLE, RIGID, ONE PIECE W/FLUSH PORT	52525-30B4	10MM DIA., 36CM, ESOPHAGEAL RETRACTOR-GASTRIC BAND MANIPULATOR, 90°, ANGULATION, WITH RING RATCHET HANDLE, ROTATABLE- ONE PIECE W/ FLUSH PORT
52515-30A4	10MM DIA., 41CM, ESOPHAGEAL RETRACTOR-GASTRIC BAND MANIPULATOR, 90°, ANGULATION, WITH RING RATCHET HANDLE, RIGID, ONE PIECE W/FLUSH PORT	52515-30B4	10MM DIA., 41CM, ESOPHAGEAL RETRACTOR-GASTRIC BAND MANIPULATOR, 90°, ANGULATION, WITH RING RATCHET HANDLE, ROTATABLE- ONE PIECE W/ FLUSH PORT



ITEM NO.	DESCRIPTION	ITEM NO.	DESCRIPTION
52525-21A12	5MM DIA., 36CM, ESOPHAGEAL RETRACTOR-GASTRIC BAND MANIPULATOR, 90°, ANGULATION, RING AXIAL HANDLE W/ RATCHET, RIGID, ONE PIECE W/FLUSH PORT	52525-21B12	5MM DIA., 36CM, ESOPHAGEAL RETRACTOR-GASTRIC BAND MANIPULATOR, 90°, ANGULATION, RING AXIAL HANDLE W/ RATCHET, ROTATABLE- ONE PIECE W/ FLUSH PORT
52515-21A12	5MM DIA., 41CM, ESOPHAGEAL RETRACTOR-GASTRIC BAND MANIPULATOR, 90°, ANGULATION, RING AXIAL HANDLE W/ RATCHET, RIGID, ONE PIECE W/FLUSH PORT	52515-21B12	5MM DIA., 41CM, ESOPHAGEAL RETRACTOR-GASTRIC BAND MANIPULATOR, 90°, ANGULATION, RING AXIAL HANDLE W/ RATCHET, ROTATABLE- ONE PIECE W/ FLUSH PORT
52525-30A12	10MM DIA., 36CM, ESOPHAGEAL RETRACTOR-GASTRIC BAND MANIPULATOR, 90°, ANGULATION, RING AXIAL HANDLE W/ RATCHET, RIGID, ONE PIECE W/FLUSH PORT	52525-30B12	10MM DIA., 36CM, ESOPHAGEAL RETRACTOR-GASTRIC BAND MANIPULATOR, 90°, ANGULATION, RING AXIAL HANDLE W/ RATCHET, ROTATABLE- ONE PIECE W/ FLUSH PORT
52515-30A12	10MM DIA., 41CM, ESOPHAGEAL RETRACTOR-GASTRIC BAND MANIPULATOR, 90°, ANGULATION, RING AXIAL HANDLE W/ RATCHET, RIGID, ONE PIECE W/FLUSH PORT	52515-30B12	10MM DIA., 41CM, ESOPHAGEAL RETRACTOR-GASTRIC BAND MANIPULATOR, 90°, ANGULATION, RING AXIAL HANDLE W/ RATCHET, ROTATABLE- ONE PIECE W/ FLUSH PORT





SNAKE RETRACTORS



MADE IN THE USA



TIP STYLE	ITEM NO.	DESCRIPTION
	52550-07	5MM, 34CM LAPAROSCOPIC RETRACTOR W/ FLEXIBLE, RIGHT ANGLED, FORMABLE TIP
	52550-05	5MM, 34CM LAPAROSCOPIC RETRACTOR W/ FLEXIBLE, TRIANGULAR, FORMABLE TIP
	52550-05-45	5MM, 45CM LAPAROSCOPIC RETRACTOR W/ FLEXIBLE, TRIANGULAR, FORMABLE TIP
	52550-06	5MM, 34CM LAPAROSCOPIC RETRACTOR W/ FLEXIBLE, TRIANGULAR, RIGHT ANGLED FORMABLE TIP
	52550-06-45	5MM, 45CM LAPAROSCOPIC RETRACTOR W/ FLEXIBLE, TRIANGULAR, RIGHT ANGLED FORMABLE TIP
	52550-08	5MM, 34CM LAPAROSCOPIC RETRACTOR W/ FLEXIBLE CIRCULAR TIP, STRAIGHT, 40MM TIP
	52550-09	5MM, 34CM LAPAROSCOPIC RETRACTOR W/ FLEXIBLE CIRCULAR TIP, ANGLED, 40MM TIP
	52550-10	5MM, 34CM LAPAROSCOPIC RETRACTOR, FLEXIBLE TIP, HOOKED, CURVED RIGHT
	52550-11	5MM, 34CM LAPAROSCOPIC RETRACTOR, FLEXIBLE TIP, HOOKED, CURVED LEFT
	52550-12R	5MM, 34CM LAPAROSCOPIC RETRACTOR, FLEXIBLE TIP, HOOKED, CURVED RIGHT, ANGLED IN SHEATH
	52550-12L	5MM, 34CM LAPAROSCOPIC RETRACTOR, FLEXIBLE TIP, HOOKED, CURVED LEFT, ANGLED IN SHEATH
	52550-13	5MM, 34CM LAPAROSCOPIC RETRACTOR, FLEXIBLE TIP, HOOKED, STRAIGHT, ANGLED IN SHEATH





FAN RETRACTORS



MADE IN THE USA



ITEM No.	DESCRIPTION
52505-15	5MM Ø, 34CM ARTICULATING FAN RETRACTOR/ELEVATOR W/ 3 FLAT, 60° ARTICULATING AND FOLDING BLADES, (60MM MAX WIDTH), ADJUSTABLE HANDLE W/ FLUSHPORT, STAINLESS STEEL
52510-15	10MM Ø, 34CM ARTICULATING FAN RETRACTOR/ELEVATOR W/ 5 FLAT, 60° ARTICULATING AND FOLDING BLADES, (90MM MAX WIDTH), ADJUSTABLE HANDLE W/ FLUSHPORT, STAINLESS STEEL
52525-15	5MM Ø, 45CM ARTICULATING FAN RETRACTOR/ELEVATOR W/ 3 FLAT, 60° ARTICULATING AND FOLDING BLADES, (60MM MAX WIDTH), ADJUSTABLE HANDLE W/ FLUSHPORT, STAINLESS STEEL
52515-15	10MM Ø, 45CM ARTICULATING FAN RETRACTOR/ELEVATOR W/ 5 FLAT, 60° ARTICULATING AND FOLDING BLADES, (90MM MAX WIDTH), ADJUSTABLE HANDLE W/ FLUSHPORT, STAINLESS STEEL

KITE RETRACTORS

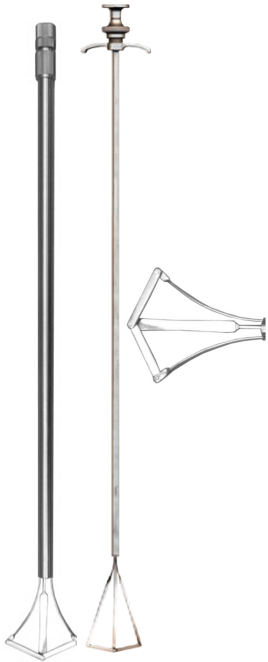

ITEM No.	DESCRIPTION
52505-50	5MM Ø, 33CM RETRACTOR/ELEVATOR CURVED, ROTATABLE, TRIANGULAR KITE-SHAPED BLADE, LOCKING HANDLE
52515-50	5MM Ø, 45CM RETRACTOR/ELEVATOR CURVED, ROTATABLE, TRIANGULAR KITE-SHAPED BLADE, LOCKING HANDLE
52505-51	5MM Ø, 33CM RETRACTOR/ELEVATOR STRAIGHT, ROTATABLE, TRIANGULAR KITE-SHAPED BLADE, LOCKING HANDLE
52515-51	5MM Ø, 45CM RETRACTOR/ELEVATOR STRAIGHT, ROTATABLE, TRIANGULAR KITE-SHAPED BLADE, LOCKING HANDLE
52510-50	10MM Ø, 33CM RETRACTOR/ELEVATOR CURVED, ROTATABLE, TRIANGULAR KITE-SHAPED BLADE, LOCKING HANDLE
52511-50	10MM Ø, 45CM RETRACTOR/ELEVATOR STRAIGHT, ROTATABLE, TRIANGULAR KITE-SHAPED BLADE, LOCKING HANDLE
52505-50T	5MM Ø, 33CM RETRACTOR/ELEVATOR CURVED, ROTATABLE, TRIANGULAR KITE-SHAPED BLADE, "T"-HANDLE
52515-50T	5MM Ø, 45CM RETRACTOR/ELEVATOR CURVED, ROTATABLE, TRIANGULAR KITE-SHAPED BLADE, "T"-HANDLE
52505-51T	5MM Ø, 33CM RETRACTOR/ELEVATOR, STRAIGHT, ROTATABLE, TRIANGULAR KITE-SHAPED BLADE, "T"-HANDLE
52515-51T	5MM Ø, 45CM RETRACTOR/ELEVATOR, STRAIGHT, ROTATABLE, TRIANGULAR KITE-SHAPED BLADE, "T"-HANDLE

MINIMALLY INVASIVE RETRACTORS/ELEVATORS



52505-40	5MM Ø, 33CM RETRACTOR/ELEVATOR 90° ARTICULATING TEFLON TIP, ACCORDING TO DR. VALLE, W/ FLUSH
52505-51	5MM Ø, 33CM ELEVATOR/PROBE STRAIGHT, TEFLON TIP, ACCORDING TO DR. VALLE
52505-39	5MM Ø, 33CM LEVER/ELEVATOR RETRACTABLE, STRAIGHT, 4-FINGER BLADES, ROTATABLE INSERT
52515-39	5MM Ø, 45CM LEVER/ELEVATOR RETRACTABLE, STRAIGHT, 4-FINGER BLADES, ROTATABLE INSERT





*ELECTROSURGICAL
GENERATORS FOR
LAPAROSCOPY*



ESU 400 DIGITAL ELECTROSURGICAL UNIT – FOR LAPAROSCOPY & OTHER MINIMALLY INVASIVE PROCEDURES



MADE IN THE USA

ADVANCED SAFETY FEATURES:

THE **ESU 400 DIGITAL** IS SPECIFICALLY DESIGNED TO ELIMINATE POTENTIAL HAZARDS DUE TO THE IMPROPER CONNECTION OF THE ACTIVE ELECTRODE ACCESSORIES **BY MAKING THE MONOPOLAR & BIPOLAR CONNECTIONS TOTALLY INCOMPATIBLE**. ON COMPETITIVE ELECTROSURGICAL UNITS, THE 4MM BANANA PLUG CONNECTIONS ARE COMMON BETWEEN THE MONOPOLAR & BIPOLAR OUTPUTS & THUS, IT IS POSSIBLE TO CONNECT A BIPOLAR FORCEPS TO THE MONOPOLAR OUTPUT, WHICH COULD LEAD TO AN EXTREMELY DANGEROUS SITUATION. YET, MANY MANUFACTURERS OF ELECTROSURGICAL EQUIPMENT, WHO CLAIM OPTIMAL SAFETY FEATURES, IGNORE OR OVERLOOK THIS.



ITEM No.
5759

ELMED ESU 400 DIGITAL: w/ SMART-MATIC CIRCUIT;
MONOPOLAR AND BIPOLAR; RETURN ELECTRODE MONITOR
(REM); COMPATIBLE w/ DUAL-CONTACT PATIENT PLATES

WHEN SAFETY, SIMPLICITY, SERVICE-FREE OPERATION, ALONG w/
ECONOMICAL PRICING IS YOUR OBJECTIVE, THE **ESU 400 DIGITAL** IS THE
UNIT FOR YOU

FEATURES OF THE ESU 400 DIGITAL:

- **SMART-O-MATIC™ CIRCUIT**-OUR AUTOMATIC OUTPUT COMPENSATION CIRCUIT PROVIDES THE DESIRED OUTPUT FOR ALL ELECTRODES OR TISSUE CONDITIONS. THE AUTOMATIC RANGE CONTROL REQUIRES NO READJUSTMENT WITHIN THE SET RANGE.
- **3 GENERATORS, ALL INDIVIDUALLY ADJUSTABLE-**
 - **GENERATOR I:** NON-MODULATED CURRENT FOR SMOOTH CUTTING AND CONTACT COAGULATION. BLEND I MODE PROVIDES CUTTING WITH LIMITED HOMEOSTASIS, BUT MORE PRONOUNCED THAN IN THE “PURE” MODE.
 - **GENERATOR II:** DELIVERS MODULATED, HIGH VOLTAGE CURRENT FOR SPRAY COAGULATION AND FULGURATION. THIS NEW SOLID STATE DESIGN PERMITS MASSIVE, FAST COAGULATION FOR UROLOGICAL, CARDIOVASCULAR AND THORACIC PROCEDURES.
 - **GENERATOR III:** A TOTALLY INDEPENDENT BIPOLAR GENERATOR, WHICH MAY BE UTILIZED AT THE SAME TIME AS THE MONOPOLAR GENERATORS, IF DESIRED. ELMED CONTINUES TO LEAD THE WAY IN BIPOLAR GENERATOR TECHNOLOGY, OFFERING A HAND-SWITCHING MODE BI-COMATIC, OR OPERATION BY CONVENTIONAL FOOT-SWITCH
- **DIGITAL READOUT**-TRUE DIGITAL READOUT FOR OUTPUT POWER IN MODELS EQUIPPED WITH A DIGITAL MONITOR, WHICH ACCURATELY INDICATES THE POWER WHICH WILL BE DELIVERED, CALIBRATED TO A 300 OHM LOAD. EVEN CHANGES IN OUTPUT POWER, WHEN SELECTING THE BLENDED MODES FOR GENERATOR I, ARE REGISTERED ON THIS ADVANCED DIGITAL INDICATOR.
- **SAFETY CIRCUIT**-AUTOMATIC SENSING DEVICE IN THE PATIENT RETURN CIRCUIT DEACTIVATES THE MONOPOLAR GENERATOR IF THE PATIENT PLATE CIRCUIT IS DEFECTIVE. WHEN ONLY THE BIPOLAR GENERATOR IS USED, THE PATIENT PLATE DOES NOT HAVE TO BE UTILIZED.
- **RETURN ELECTRODE MONITOR (REM)**-WHEN TWO-SECTION PATIENT RETURN ELECTRODES ARE DESIRABLE WITH THE REM CIRCUIT, SELECT MODEL No. **5757** AND No. **5759**.





ESU 400 DIGITAL ELECTROSURGICAL UNIT – FOR LAPAROSCOPY & OTHER MINIMALLY INVASIVE PROCEDURES



MADE IN THE USA

SUGGESTED OPTIONAL ACCESSORIES:

ITEM NO.	DESCRIPTION
5047	REUSABLE PATIENT PLATE
5071	CONNECTING CABLE FOR REUSABLE STAINLESS STEEL PATIENT PLATES (#5046 & 5047)
5044	RUBBER RETAINING STRAP FOR REUSABLE PATIENT PLATE
5395	SELF-ADHESIVE DISPOSABLE PATIENT PLATE (PKG. 25)
5702	PATIENT PLATE CONNECTING CABLE FOR DISPOSABLE PATIENT PLATE
5999	R.E.M. MODIFICATION W/ ADAPTER. INSTALL CIRCUIT FOR RETURN ELECTRODE MONITOR SYSTEM
4755	ELMED EQUIPMENT TROLLEY W/ ONE DRAWER
5706	DOUBLE-PEDAL, EXPLOSION-PROOF FOOT-SWITCH (MONOPOLAR)
5709	DOUBLE-PEDAL, UL-APPROVED FOOT-SWITCH (MONOPOLAR)
5703	SINGLE-PEDAL, WATER-SEALS FOOT-SWITCH (BIPOLAR)
5707	SINGLE-PEDAL, UL-APPROVED FOOT-SWITCH (BIPOLAR)

TECHNICAL DATA OF THE ELMED ESU 400 DIGITAL:

OUTPUT POWER:

- **GENERATOR I**, MEASURED AT 300 OHM LOAD NON-MODULATED SINUSOIDAL CURRENT 400 WATTS MODULATED BLEND I CURRENT 150 WATTS MODULATED BLEND II CURRENT 100 WATTS
- **GENERATOR II**, MEASURED AT 300 OHM LOAD MODULATED, HIGH VOLTAGE “COAGULATION” CURRENT 70 WATTS
- **GENERATOR III**, MEASURED AT 100 OHM LOAD NON-MODULATED, LOW VOLTAGE BIPOLAR CURRENT 70 WATTS

OPERATING FREQUENCY: 500 KHZ

DIMENSIONS: 15.5”W x 12.5”D x 6”H (40CM W x 32CM D x 15CM H)

WEIGHT: 14 LBS. (6.5 KG)

POWER REQUIREMENTS: 117 VOLTS, 60 HZ, 4 (OTHER POWER REQUIREMENTS UPON REQUEST)

TECHNICAL DATA FOR WATTAGE, VOLTAGE AND FREQUENCY: ±20%

UNIT MEETS LATEST ELECTRICAL SAFETY STANDARDS OF US 544, CSA, NFPA, AND IEC PROPOSED STANDARDS.





ELMED LAPAROSCOPIC LBC 50-P DIGITAL BIPOLAR GENERATOR W/ INTEGRATED AMMETER, VISUAL COAGULATION INDICATOR AUTOMATIC SHUT-OFF



MADE IN THE USA

THE MOST PROVEN METHOD OF TUBULAR STERILIZATION IS NOW MORE SIMPLIFIED AND ACCURATE W/ OUR POSITIVE RHEOSTAT BIPOLAR INTENSITY SELECTION W/ DIGITAL DISPLAY



- AUTOMATICALLY DELIVERS THE LOWEST POWER REQUIRED TO ACHIEVE THOROUGH COAGULATION OF TISSUE.
- UTILIZES CUTTING WAVE FORM TO ENSURE PRECISE THROUGH COAGULATION OF TISSUE WITH MINIMAL ADHERENCE TO FORCEPS
- PRECISE PRE-SELECTION OF POWER LIMIT FROM 1-50 WATTS
- ACOUSTIC AND VISUAL SIGNAL WHEN THE GENERATOR IS ACTIVATED
- PROPRIETARY ACOUSTIC AND VISUAL AMMETER ASSISTS IN DETERMINING THE ENDPOINT TO COAGULATION.
- CONTINUITY TEST OF THE GENERATOR, CABLE AND INSTRUMENT SYSTEM CAN BE PERFORMED PRIOR TO PROCEDURE BY CLOSING THE JAWS OF THE FORCEPS AND ACTIVATING THE FOOT SWITCH

52-5671 ELMED LBC 50-P BIPOLAR COAGULATOR W/ MUSICAL & VISUAL COAGULATION MONITOR & DIGITAL INTENSITY SETTING, FEATURING SMART-O-MATIC™ & INTEGRITY TESTER. (INCL. WATER-SEALED FOOT-SWITCH)

PRINCIPLE OF OPERATION:

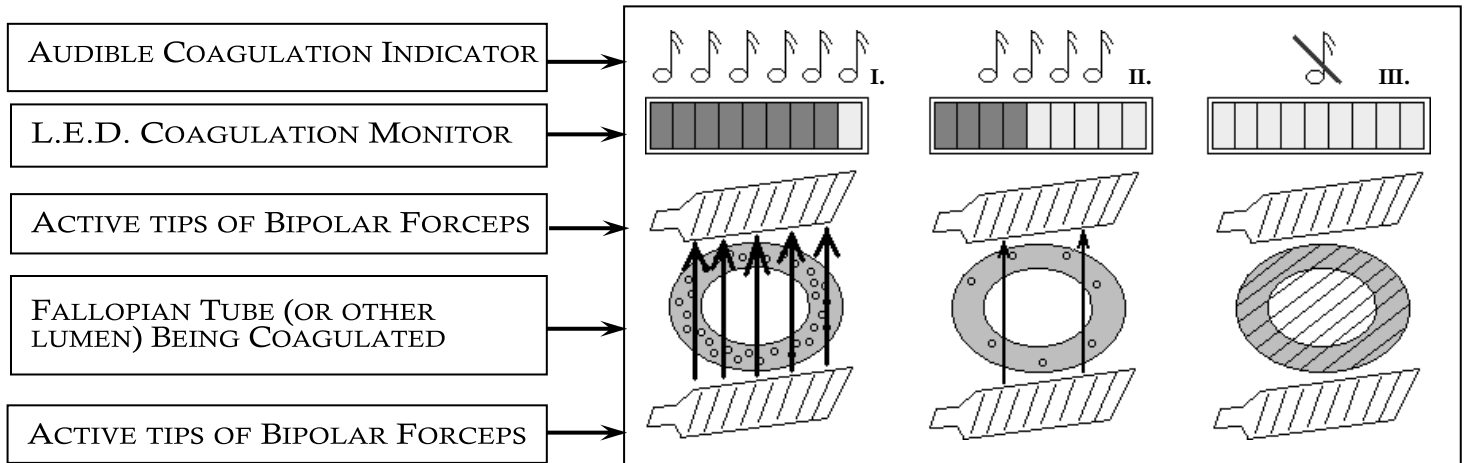

- I. AS THE BIPOLAR GENERATOR IS ACTIVATED, THE RF-CURRENT OF SELECTED INTENSITY FLOWS BETWEEN THE TWO TIPS OF BIPOLAR FORCEPS THROUGH TISSUE OF THE FALLOPIAN TUBE (OR OTHER LUMEN). THE VISUAL L.E.D. DISPLAY INDICATES THE CURRENT FLOW BY THE NUMBER OF BAR GRAPH L.E.D. UNITS LIT UP (IN ACCORDANCE W/ THE SELECTED INTENSITY) AND THE AUDIBLE INDICATOR PRODUCES A HIGH-PITCH UNINTERRUPTED CURRENT FLOW.
- II. AS THE COAGULATED TISSUE BECOMES MORE DEHYDRATED, THUS LESS ELECTRICALLY CONDUCTIVE, THE RF-CURRENT FLOW REDUCES, WHICH IS INDICATED BY THE FEWER LIT UP L.E.D.'S ON THE BAR GRAPH DISPLAY AND BY THE REDUCED IN TONE OF THE AUDIBLE INDICATOR.
- III. ONCE THE TISSUE IS COMPLETELY COAGULATED, IT BECOMES NON-CONDUCTIVE, NO RF-CURRENT CAN GO THROUGH. THE ABSENCE OF RF-CURRENT FLOW IS INDICATED BY NO LIT-UP L.E.D.'S ON THE BAR GRAPH DISPLAY AND THE SILENCE OF THE AUDIBLE INDICATOR. AT THIS MOMENT THE GENERATOR WILL SOUND AN "END TONE" SIGNAL AND THE POWER OUTPUT WILL BE SHUT DOWN; THE FOOT PEDAL MAY BE DEACTIVATED. IT IS IMPORTANT THAT THE SURGICAL SITE IS VISUALLY INSPECTED TO ENSURE COMPLETE COAGULATION. ADDITIONAL COAGULATION APPLICATION MAY BE NEEDED AT ANOTHER SITE ALONG THE FALLOPIAN TUBE TO ENSURE MAXIMUM EFFECTIVENESS.

TECHNICAL DATA:

RF OUTPUT: BIPOLAR ISOLATED (FLOATING) OUTPUT OF EXTREMELY LOW TENSION RF, 50 WATTS AT 100 OHMS (MAX. 360 V), PRECISELY ADJUSTABLE OR PRESET POSITION: 20 WATTS AT 100 OHMS (MAX. 280 V) BOTH DIGITALLY DISPLAYED

POWER SUPPLY: 115 V, 60 Hz (OTHER POWER REQUIREMENTS UPON REQUEST)

DIMENSIONS: 10" W x 9" D x 5" H (25 CM x 22.8 CM x 12.7 CM)



ELMED ARFM BIPOLAR LAPAROSCOPIC COAGULATION MONITOR



MADE IN THE USA

THE MOST PROVEN METHOD OF TUBULAR STERILIZATION IS NOW MORE SIMPLIFIED AND ACCURATE W/ OUR POSITIVE RHEOSTAT BIPOLAR INTENSITY SELECTION W/ DIGITAL DISPLAY

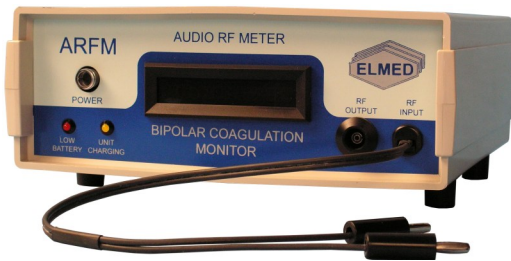

- AUTOMATICALLY DELIVERS THE LOWEST POWER REQUIRED TO ACHIEVE THOROUGH COAGULATION OF TISSUE.
- UTILIZES CUTTING WAVE FORM TO ENSURE PRECISE THROUGH COAGULATION OF TISSUE W/ MINIMAL ADHERENCE TO FORCEPS
- PRECISE PRE-SELECTION OF POWER LIMIT FROM 1-50 WATTS
- ACOUSTIC & VISUAL SIGNAL WHEN THE GENERATOR IS ACTIVATED
- PROPRIETARY ACOUSTIC & VISUAL AMMETER ASSISTS IN DETERMINING THE ENDPOINT TO COAGULATION.
- CONTINUITY TEST OF THE GENERATOR, CABLE & INSTRUMENT SYSTEM CAN BE PERFORMED PRIOR TO PROCEDURE BY CLOSING THE JAWS OF THE FORCEPS & ACTIVATING THE FOOT SWITCH

52-5675 | ELMED AREM LAPAROSCOPIC BIPOLAR COAGULATION MONITOR FOR ELMED OR WOLF GENERATORS

52-5680 | ELMED AREM LAPAROSCOPIC BIPOLAR COAGULATION MONITOR FOR VALLEYLAB, CONMED & OTHER GENERATIONS W/ TWO-BANANA PLUG CONNECTION

PRINCIPLE OF OPERATION:

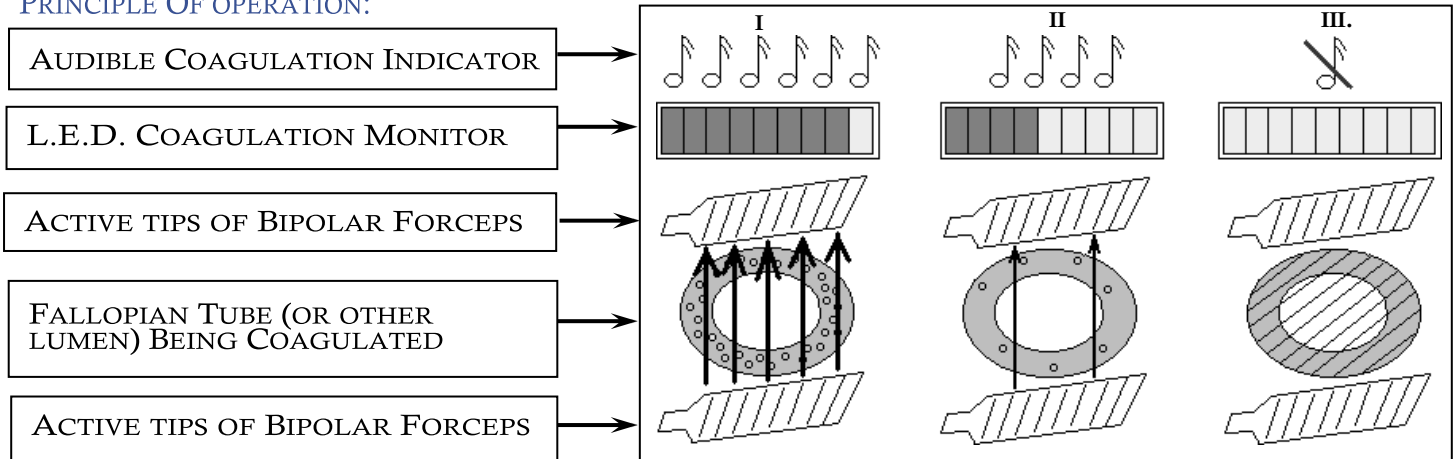

- I. AS THE BIPOLAR GENERATOR IS ACTIVATED, THE RF-CURRENT OF SELECTED INTENSITY FLOWS BETWEEN THE TWO TIPS OF BIPOLAR FORCEPS THROUGH TISSUE OF THE FALLOPIAN TUBE (OR OTHER LUMEN). THE VISUAL L.E.D. DISPLAY INDICATES THE CURRENT FLOW BY THE NUMBER OF BAR GRAPH L.E.D. UNITS LIT UP (IN ACCORDANCE W/ THE SELECTED INTENSITY) AND THE AUDIBLE INDICATOR PRODUCES A HIGH-PITCH SIGNAL (MANUAL VOLUME ADJUSTMENT KNOB ON THE BACK OF THE UNIT) TO CONFIRM THE UNINTERRUPTED CURRENT FLOW.
- II. AS THE COAGULATED TISSUE BECOMES MORE DEHYDRATED, THUS LESS ELECTRICALLY CONDUCTIVE, THE RF-CURRENT FLOW REDUCES, WHICH IS INDICATED BY THE FEWER LIT UP L.E.D.'S ON THE BAR GRAPH DISPLAY & BY THE REDUCED IN TONE OF THE AUDIBLE INDICATOR.
- III. ONCE THE TISSUE IS COMPLETELY COAGULATED, IT BECOMES NON-CONDUCTIVE, NO RF-CURRENT CAN GO THROUGH. THE ABSENCE OF RF-CURRENT FLOW IS INDICATED BY NO LIT-UP L.E.D.'S ON THE BAR GRAPH DISPLAY & THE SILENCE OF THE AUDIBLE INDICATOR. AT THIS MOMENT THE GENERATOR WILL SOUND AN "END TONE" SIGNAL & THE POWER OUTPUT WILL BE SHUT DOWN; THE FOOT PEDAL MAY BE DEACTIVATED. IT IS IMPORTANT THAT THE SURGICAL SITE IS VISUALLY INSPECTED TO ENSURE COMPLETE COAGULATION. ADDITIONAL COAGULATION APPLICATION MAY BE NEEDED AT ANOTHER SITE ALONG THE FALLOPIAN TUBE TO ENSURE MAXIMUM EFFECTIVENESS.

NOTE: BECAUSE THE ELMED ARFM BIPOLAR LAPAROSCOPIC COAGULATION MONITOR DOES NOT PRODUCE THE POWER, BUT ONLY MONITORS IT, IT WILL NOT AUTOMATICALLY SHUT OFF THE RF-CURRENT FLOW. THE MONITOR SIGNALS WHEN IT IS TIME TO MANUALLY STOP THE RF-CURRENT FLOW, (DISENGAGE THE BIPOLAR GENERATOR) VIA THE BIPOLAR FORCEPS, BY DEACTIVATING THE FOOTSWITCH. THE MONITOR IS INTENDED TO AID THE SURGEONS TO ENSURE THOROUGH COAGULATION OF THE FALLOPIAN TUBE (OR OTHER LUMENS). VISUAL INSPECTION DURING & AFTER THE COAGULATION OF THE TREATED AREA IS MANDATORY TO CONFIRM THE PROCEDURE HAS BEEN PERFORMED PROPERLY.





BIPOLAR LAPAROSCOPIC INSTRUMENTS

QUALITY, VALUE PRICED REUSABLE AMERICAN MADE SURGICAL INSTRUMENTS BY ELMED.
WHEN PRECISE ATRAUMATIC COAGULATION IS ESSENTIAL, BIPOLAR COAGULATION FORCEPS
PLAY AN IMPORTANT ROLE.

**ELMED'S GOAL IS TO PROVIDE YOU WITH THE MOST COST-EFFECTIVE, HIGH QUALITY,
REUSABLE, VALUE PRICED INSTRUMENT TO HELP YOU
REDUCE AND CONTROL YOUR SURGICAL PROCEDURE COSTS**



THE ORIGINAL KLEPPINGER BIPOLAR LAPAROSCOPIC FORCEPS



MADE IN THE USA



SYRINGE-TYPE KLEPPINGER BIPOLAR FORCEPS

5MM DIA., 32CM LENGTH		5MM DIA., 45CM LENGTH	
ITEM NO.	DESCRIPTION	ITEM NO.	DESCRIPTION
52205-100	FLAT TIP	52105-100	FLAT TIP
52205-100S	STANDARD TIP	52105-100S	STANDARD TIP
52205-100T	FENESTRATED TIP	52105-100T	FENESTRATED TIP
52205-100M	MICRO TIP	52105-100M	MICRO TIP

BIPOLAR CABLES FOR KLEPPINGER FORCEPS

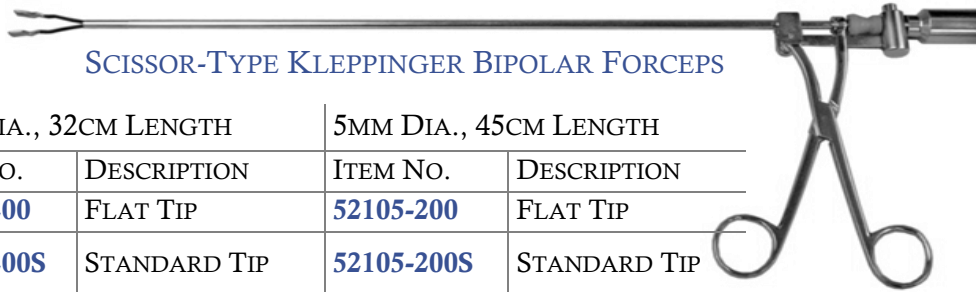

SCISSOR-TYPE KLEPPINGER BIPOLAR FORCEPS

5MM DIA., 32CM LENGTH		5MM DIA., 45CM LENGTH	
ITEM NO.	DESCRIPTION	ITEM NO.	DESCRIPTION
52205-200	FLAT TIP	52105-200	FLAT TIP
52205-200S	STANDARD TIP	52105-200S	STANDARD TIP
52205-200T	FENESTRATED TIP	52105-200T	FENESTRATED TIP
52205-200M	MICRO TIP	52105-200M	MICRO TIP

52005-24

ELMED/ WOLF KLEPPINGER PLUG & DUAL-BANANA GENERATOR PLUG

OR



52005-23

ELMED/WOLF KLEPPINGER PLUG & ELMED/WOLF GENERATOR PLUG

REUSABLE REPLACEMENT TONGS FOR KLEPPINGER TYPE FORCEPS

ALL OF OUR INNER TONGS ARE INTERCHANGEABLE WITH THE ORIGINAL WOLF STYLE

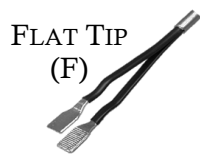

FLAT TIP (F)

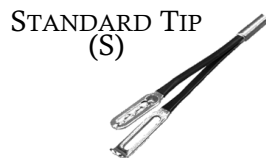

STANDARD TIP (S)

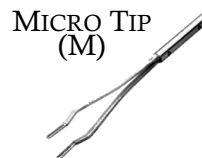

MICRO TIP (M)

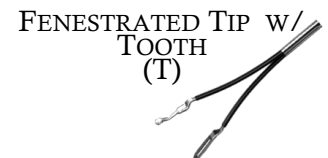

FENESTRATED TIP W/ TOOTH (T)

ITEM NO.	DESCRIPTION
52205-101	32CM- FLAT TIP (ORIGINAL KLEPPINGER) INNER TONG - F
52105-101	45CM - FLAT TIP (ORIGINAL KLEPPINGER) INNER TONG - F
52205-102	32CM - STD. TIP (FENESTRATED W/ WIRE) - INNER TONG - S
52105-102	45CM - STD. TIP (FENESTRATED W/ WIRE) - INNER TONG - S
52205-103	32CM - MICRO TIP (NARROW SHORT TIP) - INNER TONG - M
52105-103	45CM - MICRO TIP (NARROW SHORT TIP) - INNER TONG - M
52205-104	32CM - FENESTRATED TIP (FENESTRATED W/ TOOTH) - INNER TONG - T
52105-104	45CM - FENESTRATED TIP (FENESTRATED W/ TOOTH) - INNER TONG - T

NOTE:

BOTH THE SYRINGE & SCISSOR HANDLE KLEPPINGER FORCEPS ARE AVAILABLE WITH THE OPTIONAL INNER TONGS. USE THE FIRST NUMBER FROM ABOVE FOR THE INSTRUMENT & ADD THE LETTER OF YOUR CHOICE FOR THE OPTIONAL INSERT S, T, M.

WE ALSO HAVE REUSABLE REPLACEMENT TONGS AVAILABLE FOR STORZ, ACMI, PILLING AND OTHER BRANDS OF BIPOLAR LAPAROSCOPIC FORCEPS





KLEPPINGER TYPE III BIPOLAR LAPAROSCOPIC FORCEPS



MADE IN THE USA

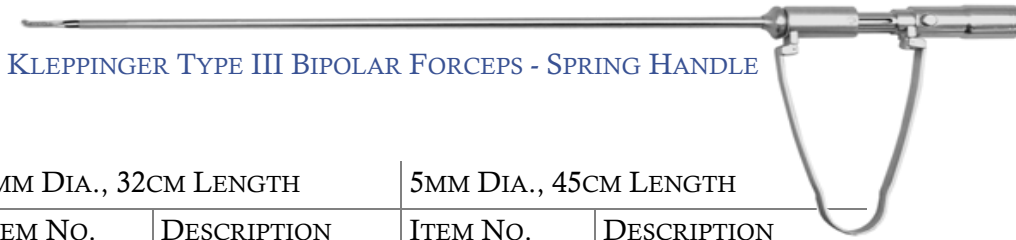

KLEPPINGER TYPE III BIPOLAR FORCEPS - SPRING HANDLE

5MM DIA., 32CM LENGTH		5MM DIA., 45CM LENGTH	
ITEM NO.	DESCRIPTION	ITEM NO.	DESCRIPTION
52205-85S	STD. TIP	52105-67S	STD. TIP
52205-85F	FLAT TIP	52105-67F	FLAT TIP
52205-85M	MICRO TIP	52105-67M	MICRO TIP

BIPOLAR CABLES FOR USE WITH ELMED TYPE III KLEPPINGER FORCEPS



52005-20

ELMED TYPE III KLEPPINGER PLUG & DUAL-BANANA GENERATOR PLUG

OR



52005-19

ELMED TYPE III KLEPPINGER PLUG & ELMED/WOLF GENERATOR PLUG

FEATURES:

- MICRO POLISHED TIP
- STATIONARY INNER TONG - IT DOES NOT MOVE IN & OUT WHILE OPENING & CLOSING, GIVING THE SURGEON COMPLETE CONTROL OF PLACEMENT
- NEW TYPE OF CABLE CONNECTOR FOR EASIER CLEANING OF HANDLE & POSITIVE CONNECTION
- INTERCHANGEABLE INNER TONGS
- PRESSURE-LOADED MECHANISM OF THE SPRING HANDLE ASSISTS IN CLOSING OF THE INSTRUMENT

REUSABLE REPLACEMENT TONGS FOR KLEPPINGER TYPE III

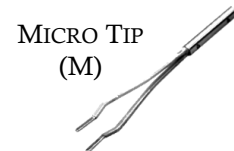
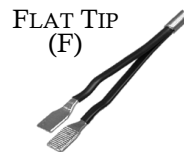
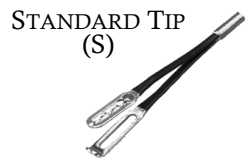

STD. TIP FOR SECURE SLIP-FREE GRIP		FLAT TIP, CONVENTIONAL KLEPPINGER STYLE		MICRO TIP FOR PRECISE, PIN-POINT COAGULATION	
32CM	45CM	32CM	45CM	32CM	45CM
52205-44	52105-70	52205-91	52105-71	52205-47	52105-72

NOTE:

WHEN ORDERING REPLACEMENT TONGS FOR ELMED SLIDE HANDLE BIPOLAR FORCEPS WITH A SINGLE TUBE OR WITH IRRIGATION TUBE, ADD LETTERS "ST" TO THE ABOVE LIST NUMBERS (THE PRICE REMAINS THE SAME). FOR HANDLE REPLACEMENT PARTS FOR ALL ELMED LAPAROSCOPIC BIPOLAR FORCEPS REFER TO THE OPERATING INSTRUCTIONS.





POWERGRIP BIPOLAR SCISSORS & FORCEPS



MADE IN THE USA



FEATURES:

- THE BIPOLAR POWERGRIP COAGULATION FORCEPS IS AN INSTRUMENT USED FOR GRASPING, CUTTING AND BIPOLAR COAGULATION IN MINIMALLY INVASIVE SURGERY. THEIR MECHANISM ENABLES ACTIVE AND PRECISE OPENING AND CLOSING OF THE JAWS AS WELL AS APPLYING VERY HIGH PRESSURE WHEN GRASPING AND CUTTING WHILE PRECISELY COAGULATING THE TISSUE. ELECTRODE INSERTS FOR DIFFERENT APPLICATIONS CAN BE EXCHANGED WITHIN A FEW SECONDS
- 3-PIECE TAKE APART FOR EFFICIENT CLEANING AND INTERCHANGE OF INSERTS.
- THE PLUG FOR STANDARDIZED BIPOLAR CABLES, WHICH ENABLES THE CONNECTION TO NEARLY ALL COMMON HIGH FREQUENCY GENERATORS, IS INTEGRATED IN THE PARTICULARLY ERGONOMIC HANDLE.
- REUSABLE INSTRUMENT AND BIPOLAR CABLE FOR COST CONTAINMENT.



52205-510 | 5MM, 34CM SCISSORS, CURVED



52205-521 | 5MM, 34CM LARGE GRASPING FORCEPS



52205-524 | 5MM, 34CM CLAW FORCEPS



52205-516 | 5MM, 34CM MARYLAND DISSECTOR, CURVED



52205-522 | 5MM, 34CM FORCEPS, CURVED



52205-520 | 5MM, 34CM GRASPING FORCEPS, CURVED



52205-523 | 5MM, 34CM DELTA GRASPER

BIPOLAR CABLES FOR USE WITH ELMED BIPOLAR POWERGRIP FORCEPS & SCISSORS



52005-22
ELMED TYPE II KLEPPINGER PLUG & DUAL-BANANA GENERATOR PLUG

OR



52005-21
ELMED TYPE II KLEPPINGER PLUG & ELMED/WOLF GENERATOR PLUG





360° ROTATABLE ORBITARIS BIPOLAR



MADE IN THE USA

FEATURES:

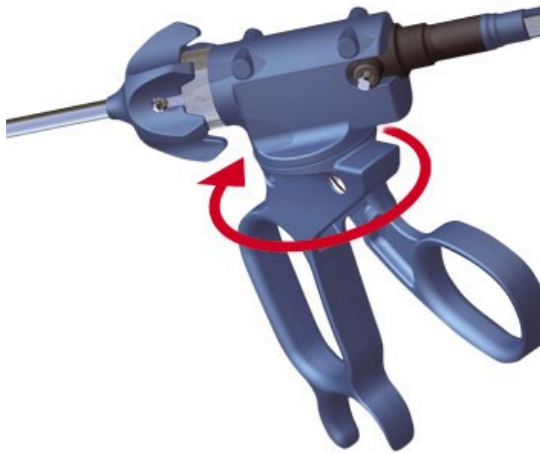

- THE HANDLE CAN BE ROTATED THROUGH 360°, SO THE SURGEONS IDEAL ERGONOMIC HANDLING POSITION CAN BE ACHIEVED. THE SURGEON AND PATIENT REQUIREMENT FOR FUNCTION AND SAFETY HAS BEEN GREATLY ENHANCED, OVER STANDARD HANDLES, TO INCLUDE SURGEON COMFORT DURING THE DEMANDS OF MINIMALLY INVASIVE SURGERY.
- 3-PIECE TAKE APART FOR EFFICIENT CLEANING AND INTERCHANGE OF INSERTS.
- THE PLUG FOR STANDARDIZED BIPOLAR CABLES, WHICH ENABLES THE CONNECTION TO NEARLY ALL COMMON HIGH FREQUENCY GENERATORS, IS INTEGRATED IN THE PARTICULARLY ERGONOMIC HANDLE.
- REUSABLE INSTRUMENT AND BIPOLAR CABLE FOR COST CONTAINMENT.



52205-010

5MM, 34CM SCISSORS, CURVED



52205-021

5MM, 34CM LARGE GRASPING FORCEPS



52205-016

5MM, 34CM MARYLAND DISSECTOR, CURVED



52205-022

5MM, 34CM FORCEPS, CURVED, FENESTRATED



52205-024

5MM, 34CM GRASPING FORCEPS W/ 2X3 TEETH



52205-023

5MM, 34CM TOUCAN GRASPING FORCEPS

BIPOLAR CABLES FOR USE WITH ELMED BIPOLAR POWERGRIP FORCEPS & SCISSORS



52005-22

ELMED TYPE II KLEPPINGER PLUG & DUAL-BANANA GENERATOR PLUG

OR



52005-21

ELMED TYPE II KLEPPINGER PLUG & ELMED/WOLF GENERATOR PLUG





POWERGRIP 3.0MM BIPOLAR DISSECTOR & GRASPER





MADE IN THE USA

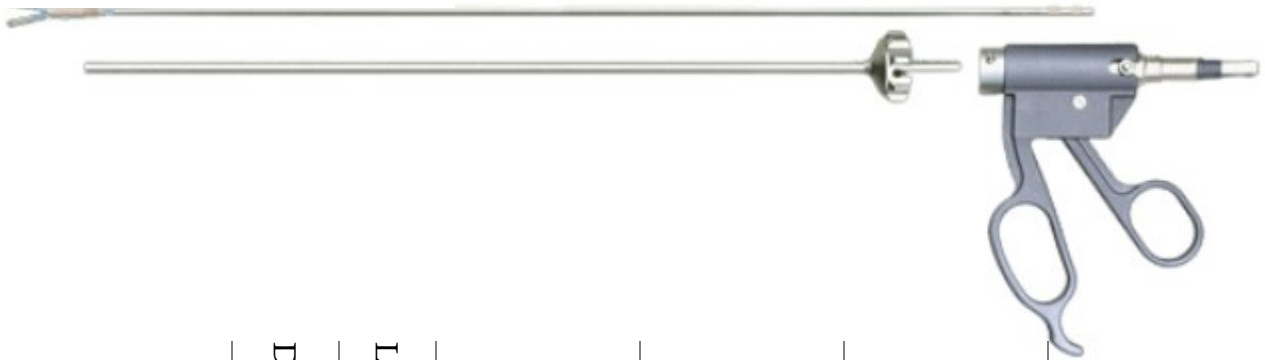

FEATURES:

- POWERGRIP 3.0 MICRO - BIPOLAR COAGULATION FORCEPS 0 3MM OFFER ALL BENEFITS OF THE TRIED AND TESTED POWERGRIP COAGULATION PLIERS, BUT ENTICE WITH THEIR SHAFT DIAMETER OF ONLY 3 MM
- 3-PIECE TAKE APART FOR EFFICIENT CLEANING AND INTERCHANGE OF INSERTS.
- THE PLUG FOR STANDARDIZED BIPOLAR CABLES, WHICH ENABLES THE CONNECTION TO NEARLY ALL COMMON HIGH FREQUENCY GENERATORS, IS INTEGRATED IN THE PARTICULARLY ERGONOMIC HANDLE.
- REUSABLE INSTRUMENT AND BIPOLAR CABLE FOR COST CONTAINMENT.



TIP ID	DIAMETER	LENGTH	INSERT NO.	HANDLE NO.	SHAFT NO.	COMPLETE INSTRUMENT
MARYLAND DISSECTOR, CURVED	3MM	20CM	53020-322I	52203-152	52203-204	53020-322
	3MM	29CM	53029-302I	52203-152	52203-202	53029-302
FENESTRATED GRASPING FORCEPS	3MM	20CM	53020-320I	52203-152	52203-204	53020-320
	3MM	29CM	53029-300I	52203-152	52203-202	53029-300

BIPOLAR CABLES FOR USE WITH ELMED BIPOLAR DISSECTOR & GRASPER



OR



52005-22

ELMED TYPE II KLEPPINGER PLUG & DUAL-BANANA GENERATOR PLUG

52005-21

ELMED TYPE II KLEPPINGER PLUG & ELMED/WOLF GENERATOR PLUG





CLASSIC BIPOLAR SCISSORS & FORCEPS





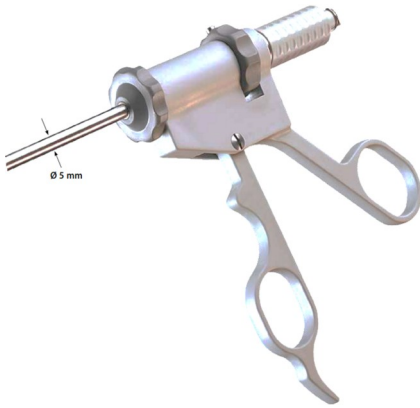



MADE IN THE USA



FEATURES:

- THE BIPOLAR COAGULATION FORCEPS WHICH CAN BE DISMANTLED IS A REUSABLE INSTRUMENT TO BE USED FOR LAPAROSCOPY FOR GRASPING AND CUTTING THE TISSUE WITH SIMULTANEOUS BIPOLAR COAGULATION. THE EASY DISMANTLING ENABLES THE USE OF DIFFERENT ELECTRODES, FACILITATES CLEANING AND THE EXECUTION OF REPAIR WORK. BY USING AN ADAPTER, THE FORCEPS CAN BE CONNECTED WITH BIPOLAR STANDARD FORCEPS CABLES TO NEARLY ALL COMMON HIGH-FREQUENCY GENERATORS.
- 3-PIECE TAKE APART FOR EFFICIENT CLEANING AND INTERCHANGE OF INSERTS.
- THE PLUG FOR STANDARDIZED BIPOLAR CABLES, WHICH ENABLES THE CONNECTION TO NEARLY ALL COMMON HIGH FREQUENCY GENERATORS, IS INTEGRATED IN THE PARTICULARLY ERGONOMIC HANDLE.
- REUSABLE INSTRUMENT AND BIPOLAR CABLE FOR COST CONTAINMENT.

ELECTRODES	DIA.	LENGTH	INSERT NO.	HANDLE NO.	INTERIOR TUBE	EXTERIOR TUBE	DIN PLUG	COMPLETE INSTR.
FENESTRATED GRASPER W/ WAVE 	5MM	20CM	55020-060I	52000-001	55020-051	55020-052	52000-401	55020-060
	5MM	34CM	55034-010I		55034-002	55034-003		55034-010
	5MM	45CM	55045-020I		55045-006	55045-007		55045-020
FLUTED TIP, 1MM 	5MM	20CM	55020-061I	52000-001	55020-051	55020-052	52000-401	55020-061
	5MM	34CM	55034-011I		55034-002	55034-003		55034-011
	5MM	45CM	55045-021I		55045-006	55045-007		55045-021
KLEPPINGER, SERRATED 	5MM	20CM	55020-063I	52000-001	55020-051	55020-052	52000-401	55020-063
	5MM	34CM	55034-013I		55034-002	55034-003		55034-013
	5MM	45CM	55045-023I		55045-006	55045-007		55045-023
TONG-TYPE BIT, 3MM 	5MM	20CM	55020-065I	52000-001	55020-051	55020-052	52000-401	55020-065
	5MM	34CM	55034-015I		55034-002	55034-003		55034-015
	5MM	45CM	55045-025I		55045-006	55045-007		55045-025
SCISSORS, CURVED 	5MM	20CM	55020-067I	52000-001	55020-051	55020-052	52000-401	55020-067
	5MM	34CM	55034-017I		55034-002	55034-003		55034-017
	5MM	45CM	55045-027I		55045-006	55045-007		55045-027
SCISSORS W/ TC BLADE CURVED 	5MM	20CM	55020-068I	52000-001	55020-051	55020-052	52000-401	55020-068
	5MM	34CM	55034-018I		55034-002	55034-003		55034-018
	5MM	45CM	55045-028I		55045-006	55045-007		55045-028
MARYLAND DISSECTOR, CURVED 	5MM	20CM	55020-069I	52000-001	55020-051	55020-052	52000-401	55020-069
	5MM	34CM	55034-019I		55034-002	55034-003		55034-019
	5MM	45CM	55045-029I		55045-006	55045-007		55045-029

BIPOLAR CABLES FOR USE WITH ELMED BIPOLAR DISSECTOR & GRASPER

52005-45

ELMED TYPE II KLEPPINGER PLUG & DUAL-BANANA GENERATOR PLUG

52005-46

ELMED TYPE II KLEPPINGER PLUG & ELMED/WOLF GENERATOR PLUG



ELMED TRIPLE FUNCTION FORCEPS SCISSORS & FORCEPS



MADE IN THE USA

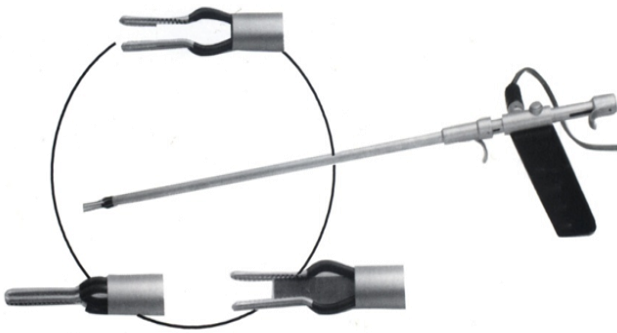

THE MOST EFFECTIVE MULTIPURPOSE INSTRUMENT OF ITS KIND, WITH FEATURES SUCH AS:

- **MULTIPLE FUNCTIONS** - SECURELY GRASP/DISSECT TISSUE/ SAFELY COAGULATE IN THE BIPOLAR MODE/ TRANSECT TISSUE/RETRACT TISSUE
- **REUSABILITY** - EASY, COST EFFECTIVE CLEANING & MAINTENANCE
- ELIMINATING COSTLY STAPLING DEVICES
- ONE INSTRUMENT, ONE INSERTION
- REDUCING PROCEDURE TIME

BIPOLAR CABLES FOR USE WITH ELMED BIPOLAR TRIPLE FUNCTION FORCEPS

ITEM NO.	DESCRIPTION
52510-00	ELMED BIPOLAR TRIPLE FUNCTION FORCEPS: 30CM LONG, 10 MM
52510-00-01	COMPLETE INNER SHAFT ASSEMBLY W/ BLADE
52510-00-02	BLADE ASSEMBLY FOR TRIPLE FUNCTION FORCEPS

ITEM NO.	DESCRIPTION
52005-80	BIPOLAR RF-CABLE FOR BIPOLAR TRIPLE FUNCTION FORCEPS & ELMED/WOLF GENERATORS
52005-81	BIPOLAR RF-CABLE FOR BIPOLAR TRIPLE FUNCTION FORCEPS & MACHINE W/ TWO BANANA-PLUG CONNECTION

ELMED BIPOLAR COAGULATION PROBES

Front (Distal) View, Enlarged



Side View (Actual Size)



ITEM NO.	DESCRIPTION
52103-35	3MM, 33CM BIPOLAR SPOT COAGULATION PROBE
52203-35	3MM, 45CM BIPOLAR SPOT COAGULATION PROBE
52205-42	5MM, 33CM BIPOLAR SPOT COAGULATION PROBE
52105-37	5MM, 45CM BIPOLAR SPOT COAGULATION PROBE

ITEM NO.	DESCRIPTION
52005-99	5MM, 33CM BIPOLAR MYOMA COAGULATOR
52005-98	5MM, 45CM BIPOLAR MYOMA COAGULATOR
52005-97	5MM, 33CM BIPOLAR MYOMA COAGULATOR, W/ TRUMPET VALVE
52005-96	5MM, 45CM BIPOLAR MYOMA COAGULATOR, W/ TRUMPET VALVE

ITEM NO. | DESCRIPTION

52205-92 | 5MM, 33CM BIPOLAR PROBE, TWO BLUNT PRONGS

52205-93 | 5MM, 33CM BIPOLAR PROBE, TWO BLUNT PRONGS W/ TRUMPET VALVE

Side View (Actual Size)

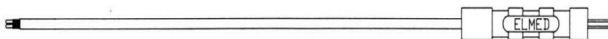

BIPOLAR CABLES FOR USE WITH ELMED BIPOLAR COAGULATION PROBES



52005-22

ELMED TYPE II KLEPPINGER PLUG & DUAL-BANANA GENERATOR PLUG

OR



52005-21

ELMED TYPE II KLEPPINGER PLUG & ELMED/WOLF GENERATOR PLUG









5MM LAPAROSCOPIC BIPOLAR ELECTRODES





MADE IN THE USA





TIP STYLE	ITEM NO.	DESCRIPTION
	52-0534-100	5MM, 34CM BIPOLAR J-HOOK ELECTRODE
	52-0534-200	5MM, 34CM BIPOLAR L-HOOK ELECTRODE
	52-0534-300	5MM, 34CM BIPOLAR SPATULA ELECTRODE
	52-0534-400	5MM, 34CM BIPOLAR DOME ELECTRODE

3MM LAPAROSCOPIC BIPOLAR ELECTRODES



TIP STYLE	ITEM NO.	DESCRIPTION
	52-0334-200	3MM, 34CM BIPOLAR L-HOOK ELECTRODE
	52-0334-700	3MM, 34CM BIPOLAR V-HOOK ELECTRODE
	52-0334-600	3MM, 34CM BIPOLAR NEEDLE ELECTRODE



TIP STYLE	ITEM NO.	DESCRIPTION
	52-0330-201	3MM, 30CM BIPOLAR L-HOOK ELECTRODE
	52-0530-301	5MM, 30CM BIPOLAR L-HOOK ELECTRODE

BIPOLAR CABLES FOR USE WITH ELMED BIPOLAR COAGULATION PROBES



OR



52005-22

ELMED TYPE II KLEPPINGER PLUG & DUAL-BANANA GENERATOR PLUG

52005-21

ELMED TYPE II KLEPPINGER PLUG & ELMED/WOLF GENERATOR PLUG



REUSABLE CABLES FOR BIPOLAR INSTRUMENTS & GENERATORS



MADE IN THE USA



ELMED/WOLF GENERATOR END



DUAL-BANANA PLUG GENERATOR END

INSTRUMENT END

ITEM NO.	DESCRIPTION
52005-21/5302	ELMED/WOLF PLUG (UNIT) & ELMED (DIN) INST. PLUG
52005-19	ELMED/WOLF PLUG (UNIT) & ELMED TYPE III INST. PLUG
52005-23	ELMED/WOLF UNIT PLUG & WOLF INST. PLUG
52005-25	ELMED/WOLF PLUG (UNIT) & STORZ/WISAP/JARIT METAL INST. PLUG
52005-17	ELMED/WOLF PLUG (UNIT) & STORZ/WISAP BARREL STYLE INST. PLUG
52005-39	ELMED/WOLF PLUG (UNIT) & KLI/CIRCON INST. PLUG
52005-41	ELMED/WOLF PLUG (UNIT) & EVEREST/COBALT INST. PLUG
52005-43	ELMED/WOLF PLUG (UNIT) & DAVOL INST. PLUG
52005-45/5991	ELMED/WOLF PLUG (UNIT) & AESCULAP/DAVOL/MARINA 2-PIN INST. PLUG
52005-60	ELMED/WOLF PLUG (UNIT) & LINVATEC/WECK/PILLING INST. PLUG
52005-91	ELMED/WOLF PLUG (UNIT) & JARIT, ERBE INST. PLUG
5950-13	ELMED/WOLF PLUG (UNIT) & ELMED BI-CUT SCISSORS



ITEM NO.	DESCRIPTION
52005-22/5230	DUAL-BANANA PLUG (UNIT) & ELMED (DIN) INST. PLUG
52005-20	DUAL-BANANA PLUG (UNIT) & ELMED TYPE III INST. PLUG
52005-24	DUAL-BANANA PLUG (UNIT) & WOLF INST. PLUG
52005-26	DUAL-BANANA PLUG (UNIT) & STORZ/WISAP/JARIT METAL PLUG
52005-18	DUAL-BANANA PLUG (UNIT) & STORZ/WISAP BARREL STYLE INST. PLUG
52005-40	DUAL-BANANA PLUG (UNIT) & KLI/CIRCON INST. PLUG
52005-42	DUAL-BANANA PLUG (UNIT) & EVEREST/COBALT INST. PLUG
52005-44	DUAL-BANANA PLUG (UNIT) & DAVOL INST. PLUG
52005-46 /5990	DUAL-BANANA PLUG (UNIT) & AESCULAP/DAVOL/MARINA 2-PIN INST. PLUG
52005-61	DUAL-BANANA PLUG (UNIT) & LINAVEC/WECK/PILLING INST. PLUG
52005-92	DUAL-BANANA PLUG (UNIT) & JARIT, ERBE INST. PLUG
5950-14	DUAL-BANANA PLUG (UNIT) & ELMED BI-CUT SCISSORS

BIPOLAR CABLE ADAPTERS



5352

ADAPTER FOR ELMED / WOLF GENERATOR PLUG & 4MM FEMALE BANANA CABLE PLUGS



52005-83

ADAPTER FOR DUAL MALE BANANA GENERATOR PLUGS & ELMED / WOLF RECEPTACLE PLUG



52005-84

ADAPTER FOR DUAL MALE BANANA GENERATOR PLUG & WOLF KLEPPINGER FORCEPS PLUG



MONOPOLAR LAPAROSCOPIC INSTRUMENTS

SUCCESSFUL AND PRECISE MONOPOLAR SURGICAL TECHNIQUES DEPEND ON PROPERLY DESIGNED AND MADE INSTRUMENTS. *ELMED* HAS BEEN A LEADER IN THE DEVELOPMENT, DESIGN AND MANUFACTURING OF THE FINEST REUSABLE ELECTROSURGICAL EQUIPMENT AND ACCESSORIES.

ELMED HAS BEEN SETTING THE PACE IN REUSABLE MONOPOLAR ELECTROSURGICAL TECHNOLOGY FOR NEARLY HALF A CENTURY.













5MM DIAMETER MONOPOLAR ELECTRODES



MADE IN THE USA

33CM, 36CM OR 45CM
SHAFT LENGTH

ELECTRODES	DIA.	LENGTH	SIDE MOUNTED RF CONNECTOR		REAR MOUNTED RF CONNECTOR	
						
J-HOOK 	5MM	33CM	52205-38		52205-81	
	5MM	36CM	52236-38		52236-81	
	5MM	45CM	52105-33		52105-81	
L-HOOK 	5MM	33CM	52205-78		52205-82	
	5MM	36CM	52236-78		52236-82	
	5MM	45CM	52105-46		52105-82	
SPATULA 	5MM	33CM	52205-56		52205-83	
	5MM	36CM	52236-56		52236-83	
	5MM	45CM	52105-46		52105-83	
CONE 	5MM	33CM	52205-36		52205-88	
	5MM	36CM	52236-36		52236-88	
	5MM	45CM	52105-31		52105-88	
BALL 	5MM	33CM	52205-07		52205-89	
	5MM	36CM	52236-07		52269-89	
	5MM	45CM	52105-07		52105-89	
KNIFE 	5MM	33CM	52205-35		52205-90	
	5MM	36CM	52236-35		52236-90	
	5MM	45CM	52105-30		52105-90	
NEEDLE 	5MM	33CM	52205-34		52205-76	
	5MM	36CM	52236-37		52236-76	
	5MM	45CM	52105-45		52105-74	
BUTTON 	5MM	33CM	52205-37		52205-37R	
	5MM	36CM	52236-37R		52236-37R	
	5MM	45CM	52205-02R		52105-02R	

MONOPOLAR CABLES FOR USE WITH ELECTRODES



52005-31

4MM DIA. PLUG (UNIT) & 4MM DIA. FEMALE INST. PLUG



52005-32

8MM DIA. "BOVIE" PLUG (UNIT) & 4MM DIA. FEMALE INST. PLUG













5MM DIAMETER MONOPOLAR ELECTRODES- WITH SUCTION/IRRIGATION PORT



MADE IN THE USA

32CM OR 45CM
SHAFT LENGTH



HANDLE STYLES	DIA.	LENGTH	J-HOOK	L-HOOK	SPATULA	CONE	SLING	KNIFE	NEEDLE	SUCTION
										
	5MM	33CM	52205-57L	52205-72L	52205-58L	52205-77L	52205-66L	52205-65L	52205-74L	52205-28L
	5MM	36CM	52236-57L	52236-72L	52236-58L	52236-77L	52236-66L	52236-65L	52236-74L	52236-28L
	5MM	45CM	52105-48L	52105-56L	52105-58L	52105-77L	52105-66L	52105-47L	52105-74L	52105-28L
	5MM	33CM	52205-57	52205-72	52205-58	52205-77	52205-66	52205-65	52205-74S	52205-27
	5MM	36CM	52236-57	52236-72	52236-58	52236-77	52236-66	52236-65	52236-74S	52236-27
	5MM	45CM	52105-48	52105-56	52105-58	52105-77	52105-66	52105-47	52105-74S	52105-24
	5MM	33CM	52205-63	52205-73	52205-64	52205-84	52205-68	52205-67	52205-74T	52205-26
	5MM	36CM	52236-63	52236-73	52236-64	52236-84	52236-68	52236-57	52236-74T	52236-26
	5MM	45CM	52105-54	52105-57	52105-50	52105-60	52105-52	52105-51	52105-74T	52105-23



MONOPOLAR CABLES FOR USE WITH ELECTRODES



52005-31

4MM DIA. PLUG (UNIT) & 4MM DIA. FEMALE INST. PLUG

52005-32

8MM DIA. "BOVIE" PLUG (UNIT) & 4MM DIA. FEMALE INST. PLUG

5MM DIAMETER MONOPOLAR ELECTRODES-FOR USE W/ HAND-SWITCHING HANDLES



"J"



"L"



SPATULA



CONE

33CM	52850-81
36CM	52836-81
45CM	52815-81

33CM	52850-82
36CM	52836-82
45CM	52815-82

33CM	52850-83
36CM	52836-83
45CM	52815-83

33CM	52850-84
36CM	52836-84
45CM	52815-84



BALL



KNIFE



NEEDLE



BUTTON

33CM	52850-85
36CM	52836-85
45CM	52815-85

33CM	52850-86
36CM	52836-86
45CM	52815-86

33CM	52850-87
36CM	52836-87
45CM	52815-87

33CM	52850-88
36CM	52836-88
45CM	52815-88



ELMED RETRACTABLE NEEDLE ELECTRODES FOR PRECISE CUTTING & COAGULATION



MADE IN THE USA

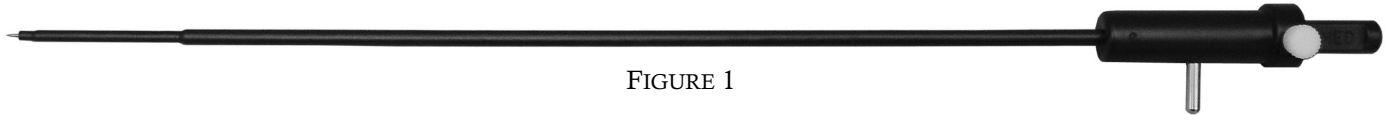

FIGURE 1

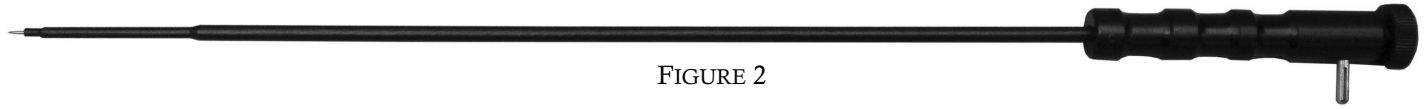

FIGURE 2

ITEM NO.	DESCRIPTION
52205-53	30CM INSULATED CUTTING ELECTRODE, RETRACTABLE NEEDLE, ACCORDING TO DR. VALLE, 5MM DIA. SHAFT W/ 3MM TIP FOR BETTER VISION, SET SCREW ADJUSTMENT (FIG. 1)
52205-54	REPLACEMENT STYLET, FOR #52205-53
52205-69	30CM INSULATED CUTTING ELECTRODE, RETRACTABLE NEEDLE, W/ IRRIGATION BY TRUMPET VALVE, ACCORDING TO DR. VALLE, 5MM DIA. SHAFT, SET SCREW ADJUSTMENT
52205-70	IRRIGATION SLEEVE ONLY, FOR #52205-69
52205-110	30CM INSULATED CUTTING ELECTRODE, RETRACTABLE NEEDLE, 5MM DIA. SHAFT W/ 3MM TIP FOR BETTER VISION, SPRING LOADED PUSH BUTTON (FIG. 2)

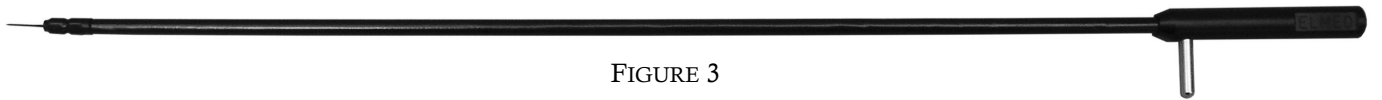

FIGURE 3

ITEM NO.	DESCRIPTION
52205-48	30CM INSULATED CUTTING ELECTRODE, W/ CHUCK FOR MICRO NEEDLES, ACCORDING TO DR. VALLE, 5MM DIA. SHAFT (FIG. 3)
52005-33	REPLACEMENT 150 MICRON NEEDLE FOR #52205-48
52005-34	REPLACEMENT 500 MICRON NEEDLE FOR #52205-48

MONOPOLAR CABLES FOR USE WITH ELECTRODES



52005-31

4MM DIA. PLUG (UNIT) & 4MM DIA. FEMALE INST. PLUG



52005-32

8MM DIA. "BOVIE" PLUG (UNIT) & 4MM DIA. FEMALE INST. PLUG



REUSABLE CABLES FOR MONOPOLAR INSTRUMENTS & GENERATORS



MADE IN THE USA



4MM "BANANA" GENERATOR END

INSTRUMENT END



8MM "BOVIE" GENERATOR END

ITEM NO.	DESCRIPTION
5021	4MM DIA. MALE INST. PLUG
5022	OLSEN TYPE SCREW-ON INST. PLUG
5029	OLYMPUS TYPE INST. PLUG
5260	ACMI TYPE INST. PLUG
5268	TAPERED "DOWNS" TYPE INST. PLUG
52005-29	3MM DIA. FEMALE INST. PLUG
52005-31	4MM DIA. FEMALE INST. PLUG
52005-35	CORSON NEEDLE ELECTRODE INST. PLUG
52005-37	DUAL STAGE MALE (STORZ) INST. PLUG
52005-47	RESECTOSCOPE INST. PLUG
52005-49	4MM DIA. RECESSED PIN (WOLF/CORSON/STORZ) INST. PLUG
52005-69	4MM DIA. SELF-RETAINING PLUG FOR STORZ SOLID POST INST.
52005-71	4MM DIA. INSULATED OUTER SLEEVE PLUG FOR V. MUELLER INST.
52005-73	4MM DIA. EXTRA-LONG PLUG & 4MM DIA. EXTRA-LONG PLUG: STORZ INST.
52005-75	4MM DIA. RIGHT ANGLE FEMALE INST. PLUG
52005-77	MALE LUER LOCK INST. PLUG
52005-53	3MM DIA. RECESSED POST PLUG FOR OLYMPUS RESECTOSCOPE
5025	SCREW ON CODMAN TYPE PLUG



ITEM NO.	DESCRIPTION
5009	4MM DIA. MALE INST. PLUG
5023	OLSEN TYPE SCREW-ON INST. PLUG
5030	OLYMPUS TYPE INST. PLUG
5261	ACMI TYPE INST. PLUG
5269	TAPERED "DOWNS" TYPE INST. PLUG
52005-30	3MM DIA. FEMALE INST. PLUG
52005-32	4MM DIA. FEMALE INST. PLUG
52005-36	CORSON NEEDLE ELECTRODE INST. PLUG
52005-38	DUAL STAGE MALE (STORZ) INST. PLUG
52005-48	RESECTOSCOPE INST. PLUG
52005-50	4MM DIA. RECESSED PIN (WOLF/CORSON/STORZ) INST. PLUG
52005-70	4MM DIA. SELF-RETAINING PLUG FOR STORZ SOLID POST INST.
52005-72	4MM DIA. INSULATED OUTER SLEEVE PLUG FOR V. MUELLER INST.
52005-74	4MM DIA. EXTRA-LONG PLUG & 4MM DIA. EXTRA-LONG PLUG: STORZ INST.
52005-76	4MM DIA. RIGHT ANGLE FEMALE INST. PLUG
52005-78	MALE LUER LOCK INST. PLUG
52005-54	3MM DIA. RECESSED POST PLUG FOR OLYMPUS RESECTOSCOPE
5026	SCREW ON CODMAN TYPE PLUG

MONOPOLAR CABLE ADAPTERS



5414 ADAPTER FOR MALE "BOVIE" GENERATOR PLUG & 4MM FEMALE BANANA CABLE PLUG



5415 ADAPTER FOR MALE "BOVIE" GENERATOR PLUG & DISPOSABLE INST. PLUG



5416 ADAPTER FOR MALE BANANA GENERATOR PLUG & DISPOSABLE INST. PLUG

IRRIGATION & SUCTION INSTRUMENTS



IN ENDOSCOPIC SURGERY, SUCH AS LAPAROSCOPIC CHOLECYSTECTOMY, PELVISCOPY OR HYSTEROSCOPIC PROCEDURES, THE ELIMINATION OF BLOOD FROM THE SURGICAL FIELD HAS TO BE DONE BY *SUCTION*. SINCE BLOOD NOT ONLY CAN CREATE PROBLEMS DURING THE ELECTROSURGICAL APPROACH, IT ALSO IS OTHERWISE UNDESIRABLE AND THUS, *IRRIGATION* IS TO “WASH” THE SURGICAL FIELD.



IRRIGATION / SUCTION TUBES



MADE IN THE USA

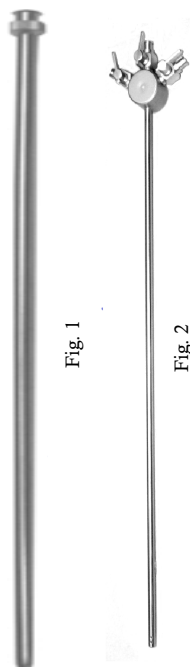

ITEM NO.	DESCRIPTION
52205-30	IRRIGATION/SUCTION TUBE W/ LUER FITTING, 33CM, 5MM DIA. -- FIG. 1
52105-26	IRRIGATION/SUCTION TUBE W/ LUER FITTING, 45CM, 5MM DIA.
52205-32	IRRIGATION/SUCTION PROBE W/ CM MARKINGS & STOPCOCK, 33CM, 5MM DIA.
52105-28	IRRIGATION/SUCTION PROBE W/ CM MARKINGS & STOPCOCK, 45CM, 5MM DIA.
52205-32T	IRRIGATION/SUCTION PROBE W/ CM MARKINGS & TRUMPET VALVE, 33CM, 5MM DIA.
52105-28T	IRRIGATION/SUCTION PROBE W/ CM MARKINGS & TRUMPET VALVE, 45CM, 5MM DIA.
52205-33	LAVAGE CANNULA W/ 3-WAY STOPCOCK, POOLE SUCTION TIP W/ LATERAL HOLES, 33CM, 5MM DIA.-- FIG. 2
52105-33	LAVAGE CANNULA W/ 3-WAY STOPCOCK, POOLE SUCTION TIP W/ LATERAL HOLES, 45CM, 5MM DIA.

EXTRA LARGE SUCTION PORTS



ITEM NO.	DESCRIPTION
52500-15-00	IRRIGATION/SUCTION SYSTEM W/ DUAL-VALVE HANDLE W/ COLOR CODING
52500-15-01	5MM DIA. 33CM, OPEN TIP SUCTION CANNULA FOR 52500-15
52500-15-02	10MM DIA. 33CM, OPEN TIP SUCTION CANNULA FOR 52500-15
52500-15-03	5MM DIA. 45CM, OPEN TIP SUCTION CANNULA FOR 52500-15
52500-15-04	10MM DIA. 45CM, OPEN TIP SUCTION CANNULA FOR 52500-15
52500-15-05	5MM DIA. 33CM, POOLE SUCTION CANNULA FOR 52500-15
52500-15-06	10MM DIA. 33CM, POOLE SUCTION CANNULA FOR 52500-15
52500-15-07	5MM DIA. 45CM, POOLE SUCTION CANNULA FOR 52500-15
52500-15-08	10MM DIA. 45CM, POOLE SUCTION CANNULA FOR 52500-15



IRRIGATION / SUCTION TUBES



MADE IN THE USA



ITEM NO.	DESCRIPTION
52500-30-00	IRRIGATION/SUCTION SYSTEM W/ DBL. "O" RING TRUMPET VALVE HANDLE, W/ INST. CHANNEL
52500-30-01	5MM DIA. 33CM, OPEN TIP SUCTION CANNULA FOR 52500-30
52500-30-02	10MM DIA., 33CM, OPEN TIP SUCTION CANNULA FOR 52500-30
52500-31-03	5MM DIA., 45CM, OPEN TIP SUCTION CANNULA FOR 52500-31
52500-31-03	10MM DIA., 45CM, OPEN TIP SUCTION CANNULA FOR 52500-31
52500-30-04	5MM DIA. 33CM, POOLE TIP SUCTION CANNULA FOR 52500-30
52500-30-05	10MM DIA., 33CM, POOLE TIP SUCTION CANNULA FOR 52500-30
52500-31-06	5MM DIA., 45CM, POOLE TIP SUCTION CANNULA FOR 52500-31
52500-31-07	10MM DIA., 45CM, POOLE TIP SUCTION CANNULA FOR 52500-31

NETZHET STYLE IRRIGATION/SUCTION SYSTEM



ITEM NO.	DESCRIPTION
52500-16-00	NETZHAT STYLE IRRIGATION/SUCTION SYSTEM W/ DUAL TRUMPET VALVE HANDLE, COMPLETE W/ 33CM, 10MM & 5MM DIA. CANNULA
52500-16-01	5MM DIA., 33CM, OPEN TIP SUCTION CANNULA FOR 52500-16
52500-16-02	10MM DIA., 33CM, OPEN TIP SUCTION CANNULA FOR 52500-16
52500-16-03	5MM DIA., 45CM, OPEN TIP SUCTION CANNULA FOR 52500-16
52500-16-04	10MM DIA., 45CM, OPEN TIP SUCTION CANNULA FOR 52500-16
52500-16-05	5MM DIA., 33CM, POOLE TIP SUCTION CANNULA FOR 52500-16
52500-16-06	10MM DIA., 33CM, POOLE TIP SUCTION CANNULA FOR 52500-16
52500-16-07	5MM DIA., 45CM, POOLE TIP SUCTION CANNULA FOR 52500-16
52500-16-08	10MM DIA., 45CM, POOLE TIP SUCTION CANNULA FOR 52500-16



IRRIGATION / SUCTION TUBES









MADE IN THE USA

5MM & 10MM SUCTION/IRRIGATION TUBES FOR HANDLES 52500-26-00 & 52500-25-00

ITEM No.
52500-26-00

ITEM No.
52500-25-00



DIA.	LENGTH	TUBE ONLY	DESCRIPTION	COMPLETE INSTRUMENT	
OPEN SUCTION TUBE					
5MM	33CM	52500-00-01	4-HOLE DISTAL TIP	52500-26-01	52500-25-01
5MM	33CM	52500-00-02	16-HOLE DISTAL TIP	52500-26-02	52500-25-02
10MM	33CM	52500-00-03	32-HOLE DISTAL TIP	52500-26-03	52500-25-03
OPEN SUCTION TUBE, BEE HIVE					
5MM	33CM	52500-00-04	48-HOLE DISTAL TIP	52500-26-04	52500-25-04
POOL SUCTION TUBE, BEE HIVE					
5MM	33CM	52500-00-05	48-HOLE DISTAL TIP	52500-26-05	52500-25-05
5MM	45CM	52500-00-06	48-HOLE DISTAL TIP	52500-26-06	52500-25-06
PUNCTURE NEEDLE					
5MM	33CM	52500-00-07	15GA NEEDLE	52500-26-07	52500-25-07
SHORT PUNCTURE					
5MM	33CM	52500-00-08	15 GA NEEDLE	52500-26-08	52500-25-08
POOLE SUCTION					
5MM	33CM	52500-00-09	12-HOLE DISTAL TIP	52500-26-09	52500-25-09





IRRIGATION / SUCTION SYSTEMS



MADE IN THE USA



ITEM NO.	DESCRIPTION
52205-30	5MM, 33CM OPEN FLAT TIP IRRIGATION/SUCTION



ITEM NO.	DESCRIPTION
	REUSABLE STAINLESS STEEL IRRIGATION/SUCTION CANNULA W/ MULTIPLE SIDE PORT HOLES & BARB HOSE FITTING
52205-30B	5MM Ø, 33CM
52105-26B	5MM Ø, 45CM



ITEM NO.	DESCRIPTION
	REUSABLE STAINLESS STEEL IRRIGATION/SUCTION CANNULA W/ STOPCOCK. FEATURING: CM MARKINGS ON DISTAL TIP (SIDE PORT HOLES-N/C OPTION ADD LETTER "M")
52205-32	5MM DIA. 33CM
52105-32L	5MM DIA. 45CM

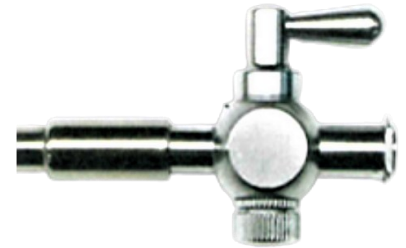

ITEM NO.	DESCRIPTION
	REUSABLE STAINLESS STEEL IRRIGATION/SUCTION CANNULA W/ STOPCOCK & BARB FITTING. FEATURING: CM MARKINGS ON DISTAL TIP (SIDE PORT HOLES-N/C OPTION ADD LETTER "M")
52205-32B	5MM DIA. 33CM
52105-25L	5MM DIA. 45CM

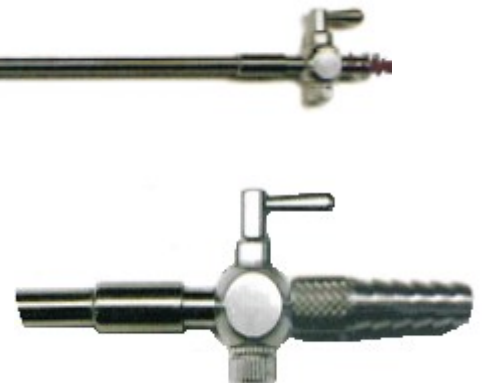







SINGLE TRUMPET OR PISTOL GRIP SUCTION/IRRIGATION SYSTEMS



MADE IN THE USA

5MM & 10MM SUCTION/IRRIGATION TUBES FOR HANDLES 52500-27-00 & 52500-28-00

				LIST NO.	LIST NO.
					
DIA.	LENGTH	TUBE ONLY	DESCRIPTION	COMPLETE INSTRUMENT	
					
3MM	33CM	52500-00-10	4-HOLE DISTAL TIP W/ CM MARKINGS		52500-28-10
3MM	33CM	52500-00-11	16-HOLE DISTAL TIP W/ CM MARKINGS	52500-27-11	52500-28-11
					
5MM	33CM	52500-00-12	4-HOLE DISTAL TIP W/ CM MARKINGS	52500-27-12	52500-28-12
5MM	33CM	52500-00-13	16-HOLE DISTAL TIP W/ CM MARKINGS	52500-27-13	52500-28-13
					
10MM	33CM	52500-00-14	4-HOLE DISTAL TIP W/ CM MARKINGS	52500-27-14	52500-28-14
10MM	33CM	52500-00-15	16-HOLE DISTAL TIP W/ CM	52500-27-15	52500-28-15

TRIPLE FUNCTION SUCTION / IRRIGATION CANNULA

OUR SPECIAL TRIPLE FUNCTION IRRIGATION/SUCTION INSTRUMENTS FEATURE INTERCHANGEABLE CANNULA AND WILL ACCEPT STANDARD INSTRUMENTS THROUGH THEIR CENTER ALLOWING THREE FUNCTIONS THROUGH ONE PORTAL. THE INSTRUMENTS CONSIST OF UNIQUE HANDLES, LIST No. 52500-11, INCORPORATING TWO TRUMPET VALVES WITH 7MM DIAMETER PORTS, ONE CONTROLS THE SUCTION, THE OTHER ONE CONTROLS THE IRRIGATION. THE 7MM DIAMETER PORTS AND PERFECT SEAL TRUMPET VALVE PROVIDE A GREATER FLOW VOLUME, NO CLOGGING AND PERFECT SEALING, THUS PREVENTING THE IRRIGATION FLUID FROM LEAKING INTO THE INSTRUMENT. THESE HANDLES AND THEIR RESPECTIVE CANNULA WILL ACCEPT STANDARD DIAMETER LAPAROSCOPIC AND PELVICOSCOPIC INSTRUMENTS.

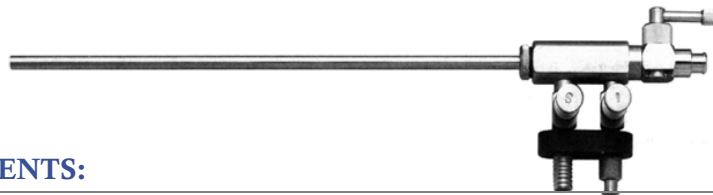

INDIVIDUAL COMPONENTS:

ITEM No.	DESCRIPTION
52500-11-00	ELMED TRIPLE-FUNCTION SUCTION/IRRIGATION SHORT HANDLE W/ TWO 7MM DIA. TRUMPET VALVES, W/OUT CANNULA
52505-21	5MM DIA., 33CM LONG CANNULA, (FOR 3MM DIA. INSTRUMENTS)
52505-22	5MM DIA., 33CM LONG SUCTION CANNULA, W/ POOLE SUCTION TIP
52505-23	5MM DIA., 45CM LONG CANNULA, (FOR 3MM DIA. INSTRUMENTS)
52505-24	5MM DIA., 45CM LONG SUCTION CANNULA, W/ POOLE SUCTION TIP
52510-01	10MM DIA., 33CM LONG CANNULA, (FOR 3MM DIA. INSTRUMENTS)
52510-02	10MM DIA., 33CM LONG SUCTION CANNULA, 5MM DIA., W/ POOLE SUCTION TIP
52510-03	10MM DIA., 45CM LONG CANNULA, 5MM DIA. (FOR 3MM DIA. INSTRUMENTS)
52510-04	10MM DIA., 45CM LONG SUCTION CANNULA, 5MM DIA., W/ POOLE SUCTION TIP



IRRIGATION / SUCTION TUBES FOR DISPOSABLE HANDLES



MADE IN THE USA



STYLE	DIAMETER	LENGTH	STRYKER™ STYLE	BAIRD™/ DAVOL™ STYLE	CARDINAL HEALTH™ PULSEWAVE ™ STYLE	CIRCON™/ ACMI™ SURGI- FLEX™ STYLE	COMED™ CORE STYLE
REGULAR TIP - VENTED STAINLESS STEEL FINISH	3MM	20CM	52720-403	52920-403	52420-403	52620-403	52820-403
	3MM	30CM	52730-403	52930-403	52430-403	52630-403	52830-403
	5MM	28CM	52728-403	52928-403	52428-403	52628-403	52828-403
	5MM	32CM	52732-403	52932-403	52432-403	52632-403	52832-403
	5MM	45CM	52745-403	52945-403	52445-403	52645-403	52845-403
	10MM	28CM	52728-404	52928-404	52428-404	52628-404	52828-404
	10MM	32CM	52732-404	52932-404	52432-404	52632-404	52832-404
REGULAR TIP -NON-VENTED REFLECTIVE FINISH	3MM	20CM	52720-409	52920-409	52420-409	52620-409	52820-409
	3MM	30CM	52730-409	52930-409	52430-409	52630-409	52830-409
	5MM	28CM	52728-409	52928-409	52428-409	52628-409	52828-409
	5MM	32CM	52732-409	52932-409	52432-409	52632-409	52832-409
	5MM	45CM	52745-409	52945-409	52445-409	52645-409	52845-409
	10MM	28CM	52728-410	52928-410	52428-410	52628-410	52828-410
	10MM	32CM	52732-410	52932-410	52432-410	52632-410	52832-410
POOLE SUCTION TIP	3MM	20CM	52720-406	52920-406	52420-406	52620-406	52820-406
	3MM	30CM	52730-406	52930-406	52430-406	52630-406	52830-406
	5MM	28CM	52728-406	52928-406	52428-406	52628-406	52828-406
	5MM	32CM	52732-406	52932-406	52432-406	52632-406	52832-406
	5MM	45CM	52745-406	52945-406	52445-406	52645-406	52845-406
	10MM	28CM	52728-405	52928-405	52428-405	52628-405	52828-405
	10MM	32CM	52732-405	52932-405	52432-405	52632-405	52832-405
10MM	45CM	52745-405	52945-405	52445-405	52645-405	52845-405	





IRRIGATION / SUCTION TUBES FOR DISPOSABLE HANDLES



MADE IN THE USA



STYLE	DIAMETER	LENGTH	STRYKER™ STYLE	BAIRD™/ DAVOL™ STYLE	CARDINAL HEALTH™ PULSEWAVE ™ STYLE	CIRCON™/ ACMI™ SURGI- FLEX™ STYLE	COMED™ CORE STYLE
STONE SCOOPER	10MM	32CM	52732-492	52932-492	52432-492	52632-492	52832-492
	10MM	45CM	52745-492	52945-492	52445-492	52645-492	52845-492
HYDRO- DISSECTION TIP	3MM	20CM	52720-407	52920-407	52420-407	52620-407	52820-407
	3MM	30CM	52730-407	52930-407	52430-407	52630-407	52830-407
	5MM	32CM	52732-407	52932-407	52432-407	52632-407	52832-407
	5MM	45CM	52745-407	52945-407	52445-407	52645-407	52845-407
ASPIRATION NEEDLE TIP	3MM	20CM	52720-437	52920-437	52420-437	52620-437	52820-437
	3MM	30CM	52730-437	52930-437	52430-437	52630-437	52830-437
	5MM	32CM	52732-437	52932-437	52432-437	52632-437	52832-437
	5MM	45CM	52745-437	52945-437	52445-437	52645-437	52845-437

OPTIONS FOR STAINLESS STEEL CANNULAS:

- NON-REFLECTIVE FINISH— ADD LETTERS “NR” TO NUMBER
- BLACK EBONIZED FINISH FOR LASER APPLICATION—ADD LETTER “E” TO NUMBER
- CUSTOM WORKING LENGTH—ADD LENGTH TO DESCRIPTION—NON-RETURNABLE





MONOPOLAR RF ELECTRODES FOR DISPOSABLE HANDLES



MADE IN THE USA

- DOUBLE INSULATED W/ REPLACEABLE TIP PROTECTOR SLEEVE FOR INCREASED SAFETY
- QUICK DISCONNECT FOR EASY CLEANING & RE-STERILIZATION
- SUCTION / IRRIGATION WITH CUTTING COAGULATION

STYLE	DIAMETER	LENGTH	STRYKER™ STYLE	BAIRD™/ DAVOL™ STYLE	CARDINAL HEALTH™ PULSEWAVE™ STYLE	CIRCON™/ ACMI™ SURGI-FLEX™ STYLE	COMED™ CORE STYLE
SPATULA TIP	5MM	32CM	52732-441	52932-441	52432-441	52632-441	52832-441
	5MM	45CM	52745-441	52945-441	52445-441	52645-441	52845-441
L-HOOK TIP	5MM	32CM	52732-442	52932-442	52432-442	52632-442	52832-442
	5MM	45CM	52745-442	52945-442	52445-442	52645-442	52845-442
J-HOOK TIP	5MM	32CM	52732-443	52932-443	52432-443	52632-443	52832-443
	5MM	45CM	52745-443	52945-443	52445-443	52645-443	52845-443
NEEDLE TIP	5MM	32CM	52732-444	52932-444	52432-444	52632-444	52832-444
	5MM	45CM	52745-444	52945-444	52445-444	52645-444	52845-444
BALL TIP	5MM	32CM	52732-445	52932-445	52432-445	52632-445	52832-445
	5MM	45CM	52745-445	52945-445	52445-445	52645-445	52845-445
BULLET SUCTION TIP	5MM	32CM	52732-446	52932-446	52432-446	52632-446	52832-446
	5MM	45CM	52745-446	52945-446	52445-446	52645-446	52845-446
PROTECTOR SHEATH 3/PK	5MM	32CM	52732-500	52932-500	52432-500	52632-500	52832-500
	5MM	45CM	52745-500	52945-500	52445-500	52645-500	52845-500





STORZ TYPE LAPAROSCOPIC ELECTRODES







MADE IN THE USA



ITEM NO.	DESCRIPTION
52300-00	HANDLE W/ TRUMPET VALVE FOR SUCTION OR IRRIGATION, AUTOCLAVABLE, FOR USE W/ 5MM COAGULATION SUCTION TUBES



PICTURED **52330-28**

DISTAL TIP	SIZE	WORKING LENGTH	INSTRUMENT NO.	DESCRIPTION
	5MM	30CM	52330-28	COAGULATING CANNULA
		36CM	52336-28	
		43CM	52343-28	
	5MM	30CM	52330-58	DISSECTING SPATULA, BLUNT
		36CM	52336-58	
		43CM	52343-58	
	5MM	30CM	52330-72	DISSECTING CANNULA, L-SHAPED
		36CM	52336-72	
		43CM	52343-72	
	5MM	30CM	52330-73	CUSCHIERI DISSECTING HOOK
		36CM	52336-73	
		43CM	52343-73	
	5MM	30CM	52330-71	DISSECTING CANNULA, U-SHAPED
		36CM	52336-71	
		43CM	52343-71	





STORZ TYPE LAPAROSCOPIC ELECTRODES





MADE IN THE USA

ITEM NO.	DESCRIPTION
 52336-72	5MM, 36 CM INSULATED MONOPOLAR "L" HOOK COAGULATION & DISSECTING ELECTRODE W/ RF POST

ITEM NO.	DESCRIPTION
 52336-58	5MM, 36 CM INSULATED MONOPOLAR SPATULA COAGULATION & DISSECTING ELECTRODE W/ RF POST

ITEM NO.	DESCRIPTION
 52336-71	5MM, 36 CM INSULATED MONOPOLAR "J" HOOK COAGULATION & DISSECTING ELECTRODE W/ RF POST

ITEM NO.	DESCRIPTION
 52336-103	5MM, 36 CM SUCTION & IRRIGATION TUBE W/ LATERAL HOLES & CM MARKINGS FOR STORZ SUCTION/IRRIGATION HANDLE, STAINLESS STEEL

ITEM NO.	DESCRIPTION
 52336-03	5MM, 36 CM SUCTION & IRRIGATION CANNULA W/ LATERAL HOLES & CM MARKINGS FOR STORZ SUCTION/IRRIGATION HANDLE

ITEM NO.	DESCRIPTION
 52005-95	MONOPOLAR RF CABLE W/ 4MM FEMALE BANANA INSTRUMENT PLUG & DOUBLE CONTACT UNIT PLUG FOR USE W/ HF UNITS





TESTING, CLEANING, STERILIZATION & STORAGE

WITH THE RAPIDLY INCREASING USE OF ELECTROSURGICAL INSTRUMENTATION DURING LAPAROSCOPIC PROCEDURES, THE RISK OF INJURIES TO PATIENT AND SURGEON HAS MULTIPLIED. MANY SURGEONS, FAMILIAR TO OPEN SURGERY, OFTEN DO NOT APPRECIATE THAT LAPAROSCOPIC PROCEDURES, EMPLOYING HIGH-FREQUENCY CURRENT, REQUIRE DIFFERENT WAVEFORMS AND TECHNIQUES.

ELMED HAS BEEN AT THE FOREFRONT OF CREATING SAFER ELECTROSURGICAL INSTRUMENTATION FOR LAPAROSCOPIC PROCEDURES. BASED ON OVER 40 YEARS OF EXPERIENCE, WE HAVE DEVELOPED AND PRODUCED LAPAROSCOPIC GENERATORS AND MANY SAFETY INNOVATIONS IN COLLABORATION WITH LEADING LAPAROSCOPIC SURGEONS.

ELMED REALIZES THAT EVEN THE FINEST EQUIPMENT IS ONLY AS GOOD AS THE SUPPLIES NEEDED TO OPERATE IT. THUS, WE PAY GREAT ATTENTION TO THE QUALITY OF SUPPLIES FOR ENDOSCOPIC INSTRUMENTATION.



ELMED ENDO-TEST UNITS FOR INSULATION TESTING



MADE IN THE USA

1ST GENERATION



ITEM NO.
52-5685

ELMED ENDO-TEST UNIT - COMPLETE PKG. INCLUDES:
AUTOCLAVABLE TEST ELECTRODES (INSULATION TEST); 3MM SPONGES (5), 5MM SPONGES (5) & 10MM SPONGES (5); TEST CABLES (INSULATION TEST).
*PLEASE SPECIFY CABLE FOR VALLEYLAB UNITS IF REQUIRED – ORDER EXTRA

2ND GENERATION



52-5686

ELMED ENDO-TEST UNIT W/ MONOPOLAR & BI-POLAR CABLE TESTER CIRCUIT COMPLETE PKG. INCLUDES SAME AS #52-5685 PLUS ADAPTERS & CABLE REQUIRED FOR CABLE TEST

3RD GENERATION



52-5687

ELMED ENDO-TEST UNIT W/ MONOPOLAR & BI-POLAR CABLE TESTER CIRCUIT W/ ADVANCED SENSORY DETECTION OF INSULATION DEFECTS: COMPLETE PKG. INCLUDES SAME AS #52-5685 PLUS ADAPTERS & CABLE REQUIRED FOR CABLE TEST

ACCESSORIES FOR ENDO-TEST:

ITEM NO.	DESCRIPTION
52-5685-01	ELECTRODE FOR CAPACITANCE TEST
52-5685-02	ELECTRODE FOR INSULATION TEST
52-5685-03	5MM SPONGE INSERT FOR INSULATION TEST (10/PKG.)
52-5685-04	10MM SPONGE INSERT FOR INSULATION TEST (10/PKG.)
52-5685-05	TEST CABLE FOR INSULATION TEST W/ 4MM FEMALE CONNECTOR
52-5685-06	TEST CABLE FOR CAPACITANCE TEST W/ ¼" PHONO PLUG
52-5685-07	*TEST CABLE FOR CAPACITANCE TEST FOR VALLEYLAB UNITS
52-5685-08	3MM SPONGE INSERTS FOR INSULATION TEST (10/PKG.)

ACCESSORIES FOR CABLE TESTER:

ITEM NO.	DESCRIPTION
52-5686-11	BIPOLAR ADAPTER CABLE
52-5686-12	BOVIE PLUG ADAPTER
52-5686-13	BANANA PLUG ADAPTER
52-5686-14	BANANA PLUG CONVERTER ADAPTER
52-5680-15	BIPOLAR CABLE ADAPTER FOR KLEPPINGER FORCEPS CABLES
52-5680-16	BIPOLAR CABLE ADAPTER FOR 2-PIN PLUG CABLES
52-5680-17	ALLIGATOR TEST CLIP FOR ENDO-TESTER
52-5685-10	INSULATED HANDLE TEST ELECTRODE W/ ATTACHED CABLE, FOR USE W/ INSULATION TEST ELECTRODE



SUPPLIES FOR LAPAROSCOPIC PROCEDURES & INSTRUMENT MAINTENANCE



MADE IN THE USA

THE ELMED INSTRUMENT CLEANING KIT IS AN EFFECTIVE AND EASY-TO-USE SOLUTION TO YOUR LAPAROSCOPIC INSTRUMENTATION CLEANING NEEDS. IT WAS DESIGNED WITH YOUR CONVENIENCE IN MIND.

THE ELMED INSTRUMENT CLEANING KIT CONSISTS OF **52003-80** & **52003-81**

- A) SHEATHS & INSERT, SYRINGES, INJECTION CANNULA
 - B) SHEATHS, PIPETTES
 - C) CATHETERS
 - D) DRAINAGE TUBES
 - E) COCKS, CANNULA & SYRINGES
 - F) BOTTLES
 - G) DOUCHE FITTINGS
 - H) WATER JET PUMP
- (ALSO SUITABLE FOR DRYING IN CONJUNCTION W/ THE FITTINGS)



ITEM NO. **52003-80** | WATER JET CLEANING GUN FOR CONNECTION TO WATER FAUCET

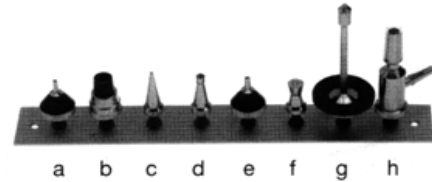

ITEM NO. **52003-81** | SET OF ADAPTERS FOR THE CLEANING OF (A) THROUGH (H)

ULTRASTOP "PRO MED" ANTI-FOGGING AGENT



ULTRASTOP IS THE MOST COST-EFFECTIVE METHOD OF PROTECTING YOUR MEDICAL OPTICS FROM FOGGING UP: IT ELIMINATES THE NEED TO WARM UP YOUR ENDOSCOPES PRIOR TO USE; AND DUE TO ITS REUSABLE STERILE PACKAGING (30 CC BOTTLES) IT CAN BE USED OVER AND OVER AGAIN

ITEM NO. **52003-37** | ULTRASTOP, PER DOZENS BOTTLES

ITEM NO. **52003-38** | ULTRASTOP, PER BOTTLE

LUBRICATING OIL FOR SURGICAL INSTRUMENTS



TO MAINTAIN HIGH QUALITY OF COSTLY SURGICAL INSTRUMENT JOINTS AND OTHER COMPONENTS, A LIGHT APPLICATION OF SURGICAL INSTRUMENTS SHOULD BE MADE PRIOR TO STERILIZATION

ITEM NO. **52003-39** | ONE DOZEN, 0.5 OZ EACH, NON-STERILE

ITEM NO. **52003-40** | ONE BOTTLE, 0.5 OZ. EACH, NON-STERILE



SUPPLIES FOR LAPAROSCOPIC PROCEDURES & INSTRUMENT MAINTENANCE



MADE IN THE USA

CLEANING BRUSHES FOR ENDOSCOPIC INSTRUMENTS



ITEM NO. (QTY. 10)	STAINLESS STEEL WIRE AND ANTI-MICROBIAL MADE IN THE USA	ITEM NO. (QTY. 1)
52003-56	2MM Ø FOR 2MM Ø CANNULAS (12" LONG)	52003-57
52003-21	4MM Ø FOR 3, 4MM Ø CANNULAS (TROCAR SLEEVES, ETC.) 12" LONG	52003-22
52003-23	6MM Ø FOR 5, 6MM Ø CANNULAS (TROCAR SLEEVES, ETC.) 12" LONG	52003-24
52003-25	8MM Ø FOR 7, 8MM Ø CANNULAS (TROCAR SLEEVES, ETC.) 12" LONG	52003-26
52003-27	12MM Ø FOR 10, 11, 12MM Ø CANNULAS (TROCAR SLEEVES, ETC.) 12" LONG	52003-28
52003-29	4MM Ø FOR 3, 4MM Ø CANNULAS (SINGLE PUNCTURE LAPAROSCOPE, ETC.) 19" LONG	52003-30
52003-31	6MM Ø FOR 5, 6 MM Ø CANNULAS (S.P. LAPAROSCOPE, BIPOLAR FCPS, ETC.) 19" LONG	52003-32
52003-33	8MM Ø FOR 7, 8MM Ø CANNULAS (S.P. LAPAROSCOPE, SUCTION TUBES, ETC.) 19" LONG	52003-34
52003-48	12MM Ø FOR 10, 11, 12MM Ø CANNULAS (LAP. INST., SUCTION TUBES, ETC.) 19" LONG	52003-49
52003-35	VERESS NEEDLES (8" LONG)	52003-36
52003-41	NYLON BRISTLE BRUSH W/ HANDLE 7" LONG 52003-43	52003-42
52003-45	STAINLESS STEEL BRISTLE BRUSH W/ HANDLE 7" LONG	52003-47
52003-54	DBL. END NYLON BRISTLE BRUCH W/ HANDLE FOR LAPAROSCOPIC INST. 7" LONG	52003-55



STERILIZATION & STORAGE CONTAINERS FOR LAP INSTRUMENTS & SCOPES



MADE IN THE USA

NEW FROM ELMED!!!

LIGHT WEIGHT ALUMINUM STERILIZATION & STORAGE CONTAINERS THAT CAN HOLD UP TO 16 INSTRUMENTS (ALSO AVAILABLE WITH A REMOVABLE (FOR GENERAL INSTRUMENTS AS WELL))



52038-48

ALUMINUM LIGHTWEIGHT LAP INSTRUMENT STERILIZATION & STORAGE CONTAINER FOR 33CM & 45CM INSTRUMENTS; HOLDS UP TO 16 5MM & 10MM DIA. INSTRUMENTS (26" X 10" X 7")

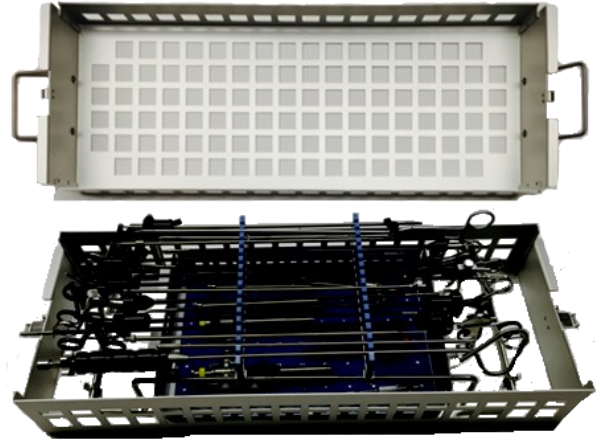

52038-49

ALUMINUM LIGHTWEIGHT LAP INSTRUMENT STERILIZATION & STORAGE CONTAINER FOR 33CM & 45CM INSTRUMENTS; HOLDS UP TO 16 5MM & 10MM DIA. INSTRUMENTS ALONG W/ TAKE OUT TRAY FOR MISC. INSTRUMENTS (26" X 10" X 7")



52038-53

LAP INSTRUMENT STERILIZATION & STORAGE CONTAINER FOR 33CM INSTRUMENTS; HOLDS UP TO 12 5MM & 10MM DIA. INSTRUMENTS (MOLDED MEDICAL GRADE POLYMER, 21" X 10" X 4")



52038-51

LAP INSTRUMENT CONTAINER W/ REMOVABLE TRAY FOR 33CM INSTRUMENT HOLDS UP TO 12 5MM & 10 DIA. INSTRUMENTS (MOLDED MEDICAL GRADE POLYMER & SILICONE, 21" X 10" X 7")

52038-54

LAP INSTRUMENT STERILIZATION & STORAGE CONTAINER FOR 45CM INSTRUMENT; HOLDS UP TO 16 5 & 10MM DIA. INSTRUMENTS (MOLDED MEDICAL GRADE POLYMER, 25" X 12" X 5")

52038-52

LAP INSTRUMENT CONTAINER W/ REMOVABLE TRAY FOR 45CM INSTRUMENT HOLDS UP TO 10 5 & 10MM DIA. INSTRUMENTS (MOLDED MEDICAL GRADE POLYMER & SILICONE, 26" X 9 1/2" X 7")





STERILIZATION & STORAGE CONTAINERS FOR LAP INSTRUMENTS & SCOPES



MADE IN THE USA



52037-00-B4

ALUMINUM STERILIZATION CONTAINER 25" X 5" X 2", w/ 4 BARS



52037-00-B2

ALUMINUM STERILIZATION CONTAINER 25" X 5" X 2", w/ 2 BARS



52037-07

THERMOPLASTIC STERILIZATION & STORAGE CONTAINER W/ SILICONE MOUNTING BARS FOR MULTIPLE LAP/HYSTO/CYSTO SCOPE OR SINGLE HYST/CYST SHEATH SYSTEM, (MOLDED MEDICAL GRADE POLYMER & SILICONE), 18"L X 7"W X 1.5"H



52037-06

THERMOPLASTIC STERILIZATION & STORAGE CONTAINER FOR 2 LAP/HYSTO/CYSTO SCOPES OR SINGLE HYST/CYST SHEATH SYSTEM, (MOLDED MEDICAL GRADE POLYMER & SILICONE), 18"L X 3"W X 1.5"H

ALSO AVAILABLE

52037-05	THERMOPLASTIC STERILIZATION & STORAGE CONTAINER FOR SINGLE LAP/HYSTO/CYSTO SCOPE OR SINGLE HYST/CYST SHEATH SYSTEM (MOLDED MEDICAL GRADE POLYMER & SILICONE) 18"L X 3"W X 1.5"H
52037-08	THERMOPLASTIC STERILIZATION & STORAGE CONTAINER (DBL. HEIGHT) FOR MULTIPLE LAP/HYSTO/CYSTO SCOPE OR SINGLE HYST/CYST SHEATH SYSTEM, (MOLDED MEDICAL GRADE POLYMER & SILICONE), 18"L X 7"W X 3"H
52038-15	STERILIZATION & STORAGE CONTAINER FOR EXTRA-LONG SCOPE & CABLE, 25" X 6" X 1.5" (MOLDED MEDICAL GRADE POLYMER & SILICONE); HOLDS 2 SCOPES UP TO 50CM LONG
52037-11	MUSLIN CLOTH FOR 52037-00 & 52037-01 CONTAINER





STERILIZATION & STORAGE CONTAINERS FOR LAP INSTRUMENTS & SCOPES



MADE IN THE USA

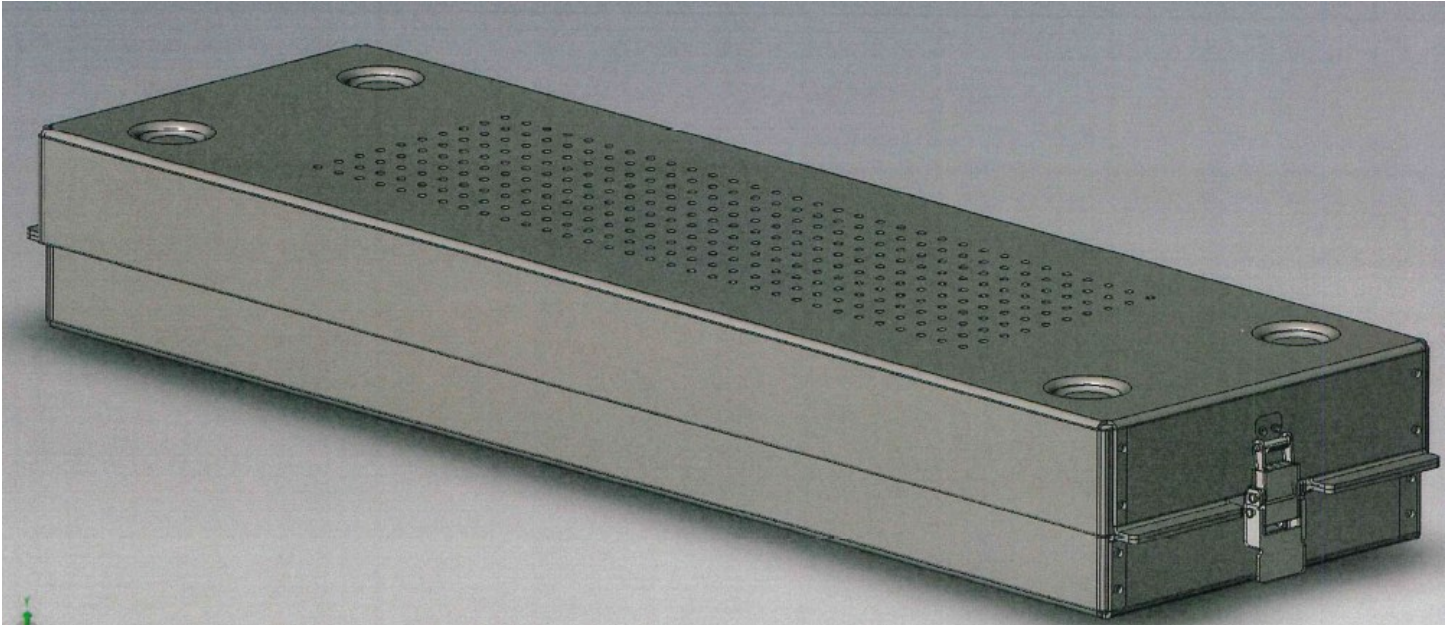

ITEM NO.	DESCRIPTION
52037-26	ALUMINUM STERILIZATION & STORAGE CONTAINER WITH LATCH . 26" x 8" x 3"
52037-26S	WITH SILICONE MAT
52037-26-B2	WITH 2 SILICONE MOUNTING BARS
52037-26-B4	WITH 4 SILICONE MOUNTING BARS





SERVICE AND REPAIR



MADE IN THE USA

IN NEED OF INSTRUMENT REPAIRS? SEND THEM TO THE *ER!*

ELMED REPAIR

60 YEARS OF EXPERIENCE AND KNOWLEDGE IN DESIGNING, ENGINEERING, MANUFACTURING AND REPAIRING FOR THE MEDICAL COMMUNITY HAS GIVEN ELMED, INC. ONE OF THE BEST REPUTATIONS IN THE INDUSTRY. WE REPAIR WHAT OTHERS ARE UNABLE OR UNWILLING TO DO AND WE REPAIR ALL COMPETITIVE BRANDS. OUR WORK IS PERFORMED BY SKILLED TECHNICIANS, ALL OF WHICH HAVE BEEN WITH ELMED FOR THE PAST 10-30 YEARS.

COMPLETE IN-HOUSE MACHINE SHOP, POWDER COATING, LASER WELDING, & MARKING FINISHING, ELECTRONICS AND OPTICAL DEPARTMENTS

AREAS OF SPECIALTY

- LAPAROSCOPIC AND ENDOSCOPIC INSTRUMENTS
- ELECTROSURGICAL UNITS AND ACCESSORIES
- FIBER OPTIC LIGHT CABLES AND RETRACTORS
- RIGID ENDOSCOPES & FLEXIBLE SINUSCOPES
- STAINLESS STEEL HAND INSTRUMENTS
- LIGHT SOURCES AND HEADLIGHTS
- DEBRIDER UNITS, HAND PIECES AND BLADES
- SELF RETAINING RETRACTOR SYSTEMS

HOW TO PACKAGE AND SHIP INSTRUMENTS

- **IMPORTANT:** ELMED CANNOT ACCEPT INSTRUMENTS THAT HAVE NOT BEEN PROPERLY CLEANED, DISINFECTED OR STERILIZED.
- INCLUDE CUSTOMER NAME AND ALL CONTACT INFORMATION (NAME, ADDRESS, PHONE NO., FAX NO., EMAIL ADDRESS, ETC.)
- INCLUDE CUSTOMER P.O. (PURCHASE ORDER), IF USED
- INCLUDE REASON FOR RETURN - BRIEF DESCRIPTION OF REPAIR PROBLEM IF AVAILABLE
- WRAP INSTRUMENT FOR PROTECTION DURING TRANSPORT
- USE A COMMON CARRIER SUCH AS UPS OR FEDEX
- INSURE THE PACKAGE AND RECORD THE TRACKING NUMBER

PLEASE FILL OUT, DETACH, AND INCLUDE THE FORM BELOW WITH YOUR REPAIR:

FROM:	
FACILITY:	CONTACT PERSON:
ADDRESS:	
CITY, STATE, ZIP	
EMAIL:	PHONE NO.
PO. No.	QTY.

INSTRUMENT DESCRIPTION:

(NOTE: PLEASE INCLUDE MODEL NO. AND SERIAL NO. IN INSTRUMENT DESCRIPTION FOR SCOPES)

FAST SERVICE: INCOMING REPAIRS COMING IN BY NEXT DAY AIR WILL BE COMPLETED WITHIN 24 HRS (WHEN PARTS ARE AVAILABLE)

SHIP TO: **ELMED** 35 N BRANDON DR., GLENDALE HEIGHTS, IL 60139