

TABLE OF CONTENTS

ENT OFFICE-BASED RADIO FREQUENCY SURGICAL PROCEDURES	PAGE
ESU 70B SURGICAL PROCEDURE SYSTEM	1
MONOPOLAR ELECTROSURGICAL ACCESSORIES FOR ENT	PAGE
REUSABLE MONOPOLAR SUCTION COAGULATION	2
REUSABLE MONOPOLAR ELECTROSURGICAL SNARES	2
REUSABLE MONOPOLAR HANDLES & ELECTRODES	3
SPECIAL REUSABLE PIN-POINT MICRO TIP ELECTRODES	4
REUSABLE RFTA ELECTRODES: 4MM DIA. SHAFT & HANDLES	5
ELECTROSURGICAL ADENOID CURETTES	6
FRAZIER MONOPOLAR SUCTION COAGULATOR	7
BIPOLAR ELECTROSURGICAL ACCESSORIES FOR ENT	PAGE
THE DENNIS PROBE BIPOLAR TURBINATE PROBE SYSTEM	8
BIPOLAR COAGULATION/DISSECTION FORCEPS FOR TONSILLECTOMY	9
BIPOLAR SURGICAL CUT-COAG SCISSORS	10
SPECIALTY SINUS INSTRUMENTS	PAGE
FIBER OPTIC AUFRICHT RETRACTOR W/ 4MM BUNDLE	11
SINUS ENDOSCOPIC CLIP APPLIER	11
SCOPES, LIGHT SOURCES & HEADLIGHTS FOR ENT	PAGE
ELMED EOS™ HD OTOSCOPES	12
ELMED EOS™ HD VIDEO OTOSCOPES	13
ELMED ES™ SINUS SCOPES	13
ELMED ES™ PARANASAL SINUS SCOPES	14
ELMED LED 2000 & 3000 LIGHT SOURCE	15
ELMED HANDY III (PORTABLE LIGHT SOURCE)	15
ELMED LITE ONE™ 300W XENON LIGHT SOURCE	16
ELMED HALOGEN LIGHT SOURCE	16
ELMED 5MM FIBER LIGHT BUNDLE, LIGHT CABLES	16
ELMED LED/ FIBER OPTIC/ HALOGEN HEADLIGHT SYSTEM	17
FESS SINUSCOPY INSTRUMENTS	PAGE
SINUS FORCEPS	18
SINUS PUNCHES	19
SINUS FORCEPS & SCISSORS	20-21
SINUSCOPY TROCARS & CANNULAS	22
SINUSCOPY ELEVATORS & KNIVES	23
SINUSCOPY CURETTES	24
SINUSCOPY DISSECTORS & PROBES	25
KILLIAN SEPTUM SPECULA W/ FIBER OPTIC LIGHT CARRIER	26
KILLIAN SEPTUM SPECULA	26

SEPTUM SPECULA & NASAL SPECULA.	27-28
ANTRUM & SPHENOIDAL PUNCHES	29-31
FIBER OPTIC LARYNGOSCOPES	PAGE
TUCKER MID-LIGHTED SIDE SLIDE LARYNGOSCOPE	32
HOLLINGER INFANT (NEWBORN) SLIDE LARYNGOSCOPE	32
JACKSON STANDARD FIBER OPTIC SLIDE LARYNGOSCOPE	32
HOLLINGER “HOUR GLASS” ANTERIOR COMMISSURE LARYNGOSCOPE	33
HOLLINGER “SLOTTED” ANTERIOR COMMISSURE LARYNGOSCOPE	33
TUCKER TRACHEOSCOPE	33
FEARON TRACHEOSCOPE	33
JACKSON DIRECT OT ANTERIOR COMMISSURE LARYNGOSCOPE	34
TUCKER-HOLLINGER ANTERIOR COMMISSURE LARYNGOSCOPE	34
HOLLINGER ANTERIOR COMMISSURE LARYNGOSCOPE	34
FIBER OPTIC MICRO-LARYNGOSCOPES	PAGE
JAKO TYPE I	35
CHERRY-JAKO TYPE I	35
JAKO MICRO-LARYNGOSCOPE TYPE II	35
CHERRY-JAKO MICRO-LARYNGOSCOPE TYPE II	36
JAKO MICRO-LARYNGOSCOPE TYPE III	36
OSSOFF-PILLING MICRO-LARYNGOSCOPE	37
DEDO–PILLING MICRO-LARYNGOSCOPE	37
LARYNGOSCOPE HOLDERS	PAGE
SCOPE HOLDER W/ ROUND CHEST PLATE	38
SCOPE HOLDER W/ STRAIGHT CHEST BAR	38
SCOPE SUSPENSION SYSTEM	38
LARYNGEAL INSTRUMENTS	PAGE
MICRO SCISSORS & FORCEPS	39
ANTERIOR COMMISSURE FORCEPS & SCISSORS	39
CUTTING FORCEPS	40
GRASPING FORCEPS	41
SCISSORS	42
PEDIATRIC FORCEPS & SCISSORS.	43
EUROTEC ENT TREATMENT CHAIRS	PAGE
EUROTEC ENT I	44
EUROTEC ENT II	44
SERVICE & REPAIR	45



ENT OFFICE BASED RADIO FREQUENCY SURGICAL PROCEDURES



MADE IN THE USA

ESU 70B SURGICAL PROCEDURE SYSTEM

WHEN SAFETY, SIMPLICITY, SERVICE-FREE OPERATION, AND ECONOMICAL PRICING ARE YOUR OBJECTIVE, THE ELMED ESU 70 B IS THE UNIT FOR YOU. ELMED, THE LEADER IN ELECTROSURGERY, MANUFACTURES ITS UNITS AND REUSABLE ACCESSORIES COMPLETELY IN-HOUSE, IN GLENDALE HEIGHTS, IL, USA WITH THE AIM TO REDUCE YOUR SURGICAL COST.

BOTH UNITS AND REUSABLE ACCESSORIES ARE SPECIFICALLY DESIGNED FOR ALL OFFICE-BASED OTOLARYNGOLOGY PROCEDURES, INCLUDING MONOPOLAR AND BIPOLAR SURGICAL PROCEDURES.



THE ELMED ESU 70 B PROVIDES TREATMENT FOR:

- NOSE BLEEDS
- TREATMENT OF SNORING
- SUBMUCOSAL TURBINATE SURGERY
- OBSTRUCTIVE TONSILLAR HYPERTROPHY
- ALL MONOPOLAR/BIPOLAR CUT, BIOPSY & COAGULATION PROCEDURES

ITEM NO.	DESCRIPTION
5196 ENT II	ENT II SURGICAL PROCEDURE SYSTEM CONSISTING OF ALL THE ITEMS LISTED BELOW
5196	ESU 70 B (INCLUDES FOOTSWITCH)
5047*	PATIENT PLATES
5701*	PATIENT PLATE CABLE
5044*	RUBBER STRAP
5021	MONOPOLAR RF-CABLE
5241-1	SUCTION COAG.. HANDLE & EXTENSION
5004	FOOTSWITCH HANDLE
5807-05	BLADE ELECTRODE
5970	DENNIS PROBE
5230	BIPOLAR RF-CABLE
4755	EQUIPMENT TROLLEY
5798B-1	RFTA HANDLE & ELECTRODE



WE DESIGN, MANUFACTURE & SELL THE TOOLS THE SURGEONS USE



MONOPOLAR ELECTROSURGICAL ACCESSORIES FOR ENT



MADE IN THE USA

REUSABLE MONOPOLAR SUCTION COAGULATION

ELMED HAS BUILT ITS STRONG REPUTATION BY DEVELOPING STATE-OF-THE-ART, INNOVATIVE ELECTROSURGICAL PRODUCTS FOR MORE THAN 40 YEARS. OUR COMPREHENSIVE LINE OF ELECTROSURGICAL INSTRUMENTATION WILL MEET AND EXCEED THE HIGHEST EXPECTATIONS OF ANY SURGICAL PROFESSIONAL. IN THE FIELD OF OTOLARYNGOLOGY, ELMED TRADITIONALLY HAS BEEN THE PACESETTER IN QUALITY, PERFORMANCE AND RELIABILITY.



ITEM No.	DESCRIPTION
5241	HANDLE: PISTOL GRIP, FOR FOOTSWITCH OPERATED SUCTION
5245	HANDLE: PISTOL GRIP, W/ HAND ACTIVATED SWITCH FOR HAND SWITCH-ENABLED GENERATORS (PLEASE SPECIFY FOR ORDER) BY DR. ELLEN BOGEN
5242	SUCTION COAGULATOR EXTENSION: 4", 2MM DIA. (NASAL)
5243	SUCTION COAGULATOR EXTENSION: 6", 2MM DIA. (NASAL)
5244	SUCTION COAGULATOR EXTENSION: 45° TIP, 4", 2MM DIA. (NASAL)
5247	SUCTION COAGULATOR EXTENSION: 45° TIP, 6", 2MM DIA. (NASAL)
5246	SUCTION COAGULATOR EXTENSION: 9", 4MM DIA. (TONSIL)
5248	MALLEABLE SUCTION COAGULATOR EXTENSION: 6", 4MM DIA. (NASAL)
5249	MALLEABLE SUCTION COAGULATOR EXTENSION: 9", 4MM DIA. (TONSIL)

REUSABLE MONOPOLAR ELECTROSURGICAL SNARES

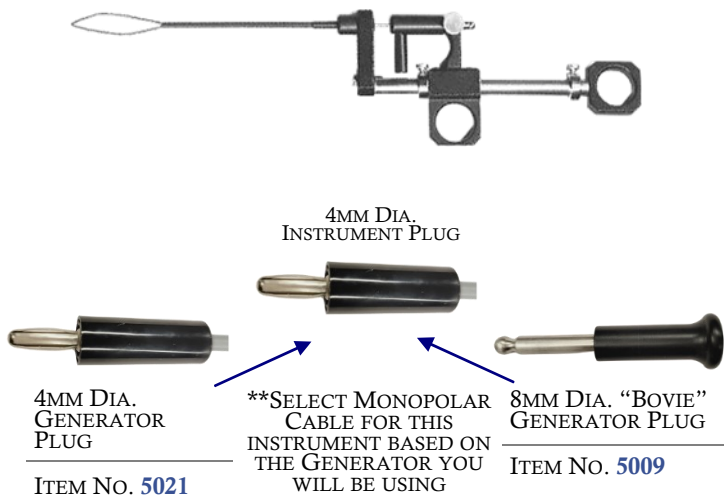

ITEM No.	DESCRIPTION
5282	NASAL SUCTION SNARE: W/ INSULATED HANDLE & 4" LONG SHAFT, ASSEMBLED WITH SELF-OPENING LOOP (ILLUSTRATED) – (REQUIRES CABLE #5021 OR #5009)
5283	TONSIL SUCTION SNARE: W/ INSULATED HANDLE & 9" LONG SHAFT, ASSEMBLED WITH SELF-OPENING LOOP (ILLUSTRATED) – (REQUIRES CABLE #5021 OR #5009)
5285	SELF-OPENING LOOP – NASAL SNARE
5286	SELF-OPENING LOOP – TONSIL SNARE



TO ORDER CALL: (224) 353-6446



MONOPOLAR ELECTROSURGICAL ACCESSORIES FOR ENT



MADE IN THE USA

REUSABLE MONOPOLAR HANDLES AND ELECTRODES



FOR REMOVAL OF SMALL POLYPS AND BIOPSIES, AS WELL AS FOR THE TREATMENT OF BLEEDING, SPECIAL ELECTRODES ARE AVAILABLE. THESE ELECTRODES FIT OUR STANDARD HANDLES (4MM DIA. SHAFT, 3MM (3/32") AND 2MM (1/16") SHAFT)

ITEM No.	DESCRIPTION
5731	HANDLE: FOOTSWITCH OPERATED, FOR 4MM DIA. ELECTRODES (REQUIRES CABLE #5021 OR #5009)
5732	HANDLE: FOOTSWITCH OPERATED, FOR 2MM DIA. ELECTRODES (REQUIRES CABLE #5021 OR #5009)
5733	HANDLE: FOOTSWITCH OPERATED, FOR 3MM (3/32") DIA. ELECTRODES (REQUIRES CABLE #5021 OR #5009)

CUTTING & COAGULATION ELECTRODES

	STANDARD/UNIVERSAL ELECTRODES FOR USE W/ ALL HANDLES INCLUDING ELMED REUSABLE HANDLES 3MM (3/32") Ø SHAFT		MICRO ELECTRODES FOR ELMED REUSABLE & ELLMAN HANDLES 2MM (1/16") Ø SHAFT		DIN/GERMAN TYPE ELECTRODES FOR ELMED & ERBE HANDLES 100, 150, 200MM LENGTHS ARE MALLEABLE 4MM (3/16") Ø SHAFT	
	SHAFT LENGTH	ITEM No.	SHAFT LENGTH	ITEM No.	SHAFT LENGTH	ITEM No.
5MM Ø WIRE LOOP ELECTRODE: INSULATED 	55MM	5709-05	55MM	5609-05	55MM	5809-05
	80MM	5709-08	80MM	5609-08	100MM	5809-08
	100MM	5709-10	100MM	5609-10	150MM	5809-10
	150MM	5709-15	150MM	5609-15	200MM	5809-15
8MM Ø WIRE LOOP ELECTRODE: INSULATED 	55MM	5710-05	55MM	5610-05	55MM	5810-05
	80MM	5710-08	80MM	5610-08	100MM	5810-08
	100MM	5710-10	100MM	5610-10	150MM	5810-1
	150MM	5710-15	150MM	5610-15	200MM	5810-15
2MM Ø COAGULATING BALL ELECTRODE: STRAIGHT, INSULATED 	55MM	5720-05	55MM	5620-05	55MM	5820-05
	80MM	5720-08	80MM	5620-08	100MM	5820-08
	100MM	5720-10	100MM	5620-10	150MM	5820-10
	150MM	5720-15	150MM	5620-15	200MM	5820-15
4MM Ø COAGULATING BALL ELECTRODE: STRAIGHT, INSULATED 	55MM	5721-05	55MM	5621-05	55MM	5821-05
	80MM	5721-08	80MM	5621-08	100MM	5821-08
	100MM	5721-10	100MM	5621-10	150MM	5821-10
	150MM	5721-15	150MM	5621-15	200MM	5821-15
8MM Ø COAGULATING BALL ELECTRODE: STRAIGHT, INSULATED 	55MM	5724-05	55MM	5624-05	55MM	5824-05
	80MM	5724-08	80MM	5624-08	100MM	5824-08
	100MM	5724-10	100MM	5624-10	150MM	5824-10
	150MM	5724-15	150MM	5624-15	200MM	5824-15
CUTTING & COAGULATING LANCET ELECTRODE: STRAIGHT, INSULATED 	*55MM	5707-05	55MM	5607-05	55MM	5807-05
	80MM	5707-08	80MM	5607-08	100MM	5807-08
	100MM	5707-10	100MM	5607-10	150MM	5807-10
	150MM	5707-15	150MM	5607-15	200MM	5807-15
CUTTING NEEDLE ELECTRODE: STRAIGHT, INSULATED 	*55MM	5706-05	55MM	5606-05	55MM	5806-05
	80MM	5706-08	80MM	5606-08	100MM	5806-08
	100MM	5706-10	100MM	5606-10	150MM	5806-10
	150MM	5706-15	150MM	5606-15	200MM	5806-15

SPECIAL REUSABLE ENT ELECTRODES



ITEM No.	DESCRIPTION
5143	NEEDLE ELECTRODE: 4MM (3/16") DIA. SHAFT, 110MM LONG ANGLED; FOER TONSIL TAPS & OTHER SUBMUCOSAL TISSUE DESTRUCTION
5143M	NEEDLE ELECTRODE: 3MM (3/32") DIA. SHAFT, 110MM LONG ANGLED; FOER TONSIL TAPS & OTHER SUBMUCOSAL TISSUE DESTRUCTION
5144	COAGULATION BALL ELECTRODE: 4MM (3/16") DIA. SHAFT, 110MM L.; ANGLED, INSULATED; FOR ENT
5144M	COAGULATION BALL ELECTRODE: 3MM (3/32") DIA. SHAFT, 110MM L.; ANGLED, INSULATED; FOR ENT





MONOPOLAR ELECTROSURGICAL ACCESSORIES FOR ENT



MADE IN THE USA

SPECIAL REUSABLE PIN-POINT MICRO TIP ELECTRODES

	TIP DESIGN	2CM LENGTH	3CM LENGTH	4CM LENGTH	10CM LENGTH
	STRAIGHT TIP (2MM DIA.)	5901-02-02	5901-03-02	5901-04-02	5901-10-02
	STRAIGHT TIP (3MM DIA.)	5901-02-03	5901-03-03	5901-04-03	5901-10-03
	45° TIP (2MM DIA.)	5902-02-02	5902-03-02	5902-04-02	5902-10-02
	45° TIP (3MM DIA.)	5902-02-03	5902-03-03	5902-04-03	5902-10-03
	TIP DESIGN	10CM LENGTH	12CM LENGTH	15CM LENGTH	18CM LENGTH
	CURVED SHAFT (2MM DIA.)	5903-10-02	5903-12-02	5903-15-02	5903-18-02
	CURVED SHAFT (3MM DIA.)	5903-10-03	5903-12-03	5903-15-03	5903-18-03



MONOPOLAR ELECTROSURGICAL ACCESSORIES FOR ENT



MADE IN THE USA

REUSABLE RFTA ELECTRODES: 4MM DIA. SHAFT & HANDLES

SUGGESTED FOR UVULOPLASTY (SHRINKING UVULA)

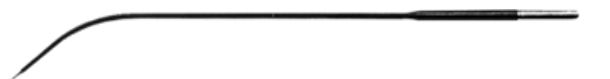

ITEM NO.	DESCRIPTION
5791	RFTA ELECTRODE: 6MM ACTIVE TIP

5792	RFTA ELECTRODE: 8MM ACTIVE TIP
-------------	--------------------------------



ITEM NO.	DESCRIPTION
5725	RFTA ELECTRODE W/ CURVED RIGID SHAFT: 7MM ACTIVE DISTAL TIP

5726	RFTA ELECTRODE W/ CURVED RIGID SHAFT: 10MM ACTIVE DISTAL TIP
-------------	--



ITEM NO.	DESCRIPTION
5725	RFTA ELECTRODE W/ CURVED RIGID SHAFT: 7MM ACTIVE DISTAL TIP

5726	RFTA ELECTRODE W/ CURVED RIGID SHAFT: 10MM ACTIVE DISTAL TIP
-------------	--

SUGGESTED FOR SUBMUCOSAL TURBINATE MONOPOLAR SURGERY



ITEM NO.	DESCRIPTION
5731	TURBINATE RFTA ELECTRODE W/ STRAIGHT RIGID SHAFT: 7MM ACTIVE DISTAL TIP

5732	TURBINATE RFTA ELECTRODE W/ STRAIGHT RIGID SHAFT: 10MM ACTIVE DISTAL TIP
-------------	--

5733	TURBINATE RFTA ELECTRODE W/ STRAIGHT RIGID SHAFT: 15MM ACTIVE DISTAL TIP
-------------	--



ITEM NO.	DESCRIPTION
5842	SPECIAL UPP ELECTRODE

SUGGESTED FOR BASE OF TONGUE TREATMENT (TONGUE ABLATION)



ITEM NO.	DESCRIPTION
5798	RFTA HANDLE W/ ATTACHED CABLE FOR ESU 120 M/M DIGITAL (ILLUSTRATED)

5798B	RFTA HANDLE W/ ATTACHED CABLE: BANANA PLUG CONNECTION
--------------	---

5799	RFTA HANDLE W/ ATTACHED CABLE & FIBER OPTIC BUNDLE
-------------	--



ITEM NO.	DESCRIPTION
5727	TURBINATE RFTA ELECTRODE W/ CURVED RIGID SHAFT & DOME: 7MM ACTIVE DISTAL TIP

5728	TURBINATE RFTA ELECTRODE W/ CURVED RIGID SHAFT & DOME: 10MM ACTIVE DISTAL TIP
-------------	---



MONOPOLAR ELECTROSURGICAL ACCESSORIES FOR ENT



MADE IN THE USA

ELECTROSURGICAL ADENOID CURETTES-DESIGNED BY DR. DONALD DENNIS

COMPLETELY REUSABLE / FULLY AUTOCLAVABLE



ITEM NO.	DESCRIPTION
5591	ELMED ELECTROSURGICAL ADENOID CURETTE, SIZE 1, STRAIGHT
5592	ELMED ELECTROSURGICAL ADENOID CURETTE, SIZE 2, STRAIGHT
5593	ELMED ELECTROSURGICAL ADENOID CURETTE, SIZE 3, STRAIGHT
5594	ELMED ELECTROSURGICAL ADENOID CURETTE, SIZE 4, STRAIGHT
5595	ELMED ELECTROSURGICAL ADENOID CURETTE, SIZE 1, W/ SUCTION STRAIGHT
5596	ELMED ELECTROSURGICAL ADENOID CURETTE, SIZE 2, W/ SUCTION STRAIGHT
5597	ELMED ELECTROSURGICAL ADENOID CURETTE, SIZE 3, W/ SUCTION STRAIGHT
5598	ELMED ELECTROSURGICAL ADENOID CURETTE, SIZE 4, W/ SUCTION STRAIGHT



Size 1



Size 2



Size 3



Size 4

ITEM NO.	DESCRIPTION
5891	ELMED ELECTROSURGICAL ADENOID CURETTE, SIZE 1, REVERSE ANGLE
5892	ELMED ELECTROSURGICAL ADENOID CURETTE, SIZE 2, REVERSE ANGLE
5893	ELMED ELECTROSURGICAL ADENOID CURETTE, SIZE 3, REVERSE ANGLE
5894	ELMED ELECTROSURGICAL ADENOID CURETTE, SIZE 4, REVERSE ANGLE
5895	ELMED ELECTROSURGICAL ADENOID CURETTE, SIZE 1, w/ SUCTION REVERSE ANGLE
5896	ELMED ELECTROSURGICAL ADENOID CURETTE, SIZE 2, w/ SUCTION REVERSE ANGLE
5897	ELMED ELECTROSURGICAL ADENOID CURETTE, SIZE 3, w/ SUCTION REVERSE ANGLE
5898	ELMED ELECTROSURGICAL ADENOID CURETTE, SIZE 4, w/ SUCTION REVERSE ANGLE

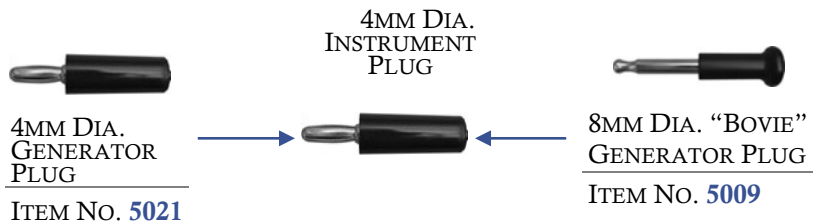



MONOPOLAR ELECTROSURGICAL ACCESSORIES FOR ENT



MADE IN THE USA

FRAZIER MONOPOLAR COAGULATOR

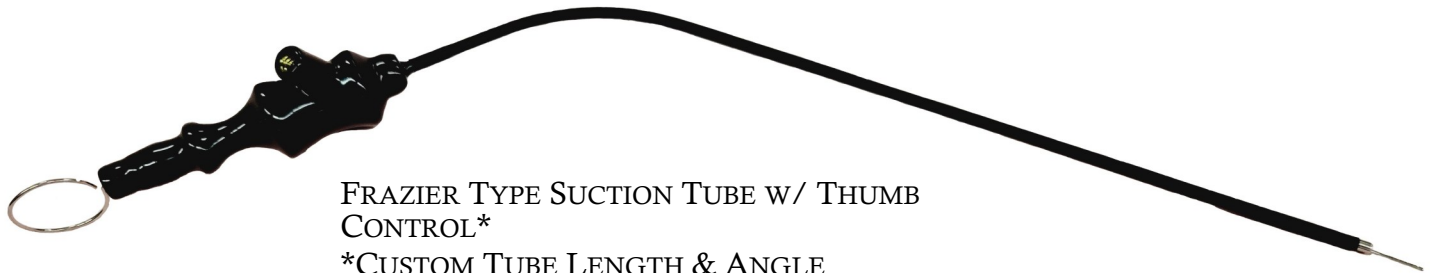

FRAZIER TYPE SUCTION TUBE W/ THUMB CONTROL*
 *CUSTOM TUBE LENGTH & ANGLE AVAILABLE, PER YOUR SPECIFICATIONS

DESCRIPTION	ITEM NO.	DIA.	DESCRIPTION	ITEM NO.	DIA.	DESCRIPTION	ITEM NO.	DIA.
5½" (140MM) ANGULAR, INSULATED, W MONOPOLAR RF CONNECTOR, REUSABLE	37-5006-06	6 FR.	7" (178MM) ANGULAR, INSULATED, W MONOPOLAR RF CONNECTOR, REUSABLE	37-5007-06	6 FR.	9" (228MM) ANGULAR, INSULATED, W MONOPOLAR RF CONNECTOR, REUSABLE	37-5009-06	6 FR.
	37-5006-07	7 FR.		37-5007-07	7 FR.		37-5009-07	7 FR.
	37-5006-08	8 FR.		37-5007-08	8 FR.		37-5009-08	8 FR.
	37-5006-09	9 FR.		37-5007-09	9 FR.		37-5009-09	9 FR.
	37-5006-10	10 FR.		37-5007-10	10 FR.		37-5009-10	10 FR.
	37-5006-11	11 FR.		37-5007-11	11 FR.		37-5009-11	11 FR.
	37-5006-12	12 FR.		37-5007-12	12 FR.		37-5009-12	12 FR.
	37-5006-115	15 FR.		37-5007-115	15 FR.		37-5009-115	15 FR.
	37-5006-18	18 FR.		37-5007-18	18 FR.		37-5009-18	18 FR.

OLSEN TYPE SCREW-ON INSTRUMENT PLUG



4MM DIA.
 GENERATOR PLUG
 ITEM NO. **5022**



8MM DIA. "BOVIE"
 GENERATOR PLUG
 ITEM. NO. **5023**





BIPOLAR ELECTROSURGICAL ACCESSORIES FOR ENT



MADE IN THE USA

THE DENNIS BIPOLAR TURBINATE PROBE SYSTEM DESIGNED AND DEVELOPED BY DONALD P. DENNIS, M.D.



ADVANTAGES OF THE DENNIS PROBE FOR CHRONIC OBSTRUCTIVE TURBINATE HYPERTROPHY:

1. IT CAN BE USED IN THE OFFICE W/ LOCAL ANESTHESIA
2. THERE IS NO INTRAOPERATIVE OR POSTOPERATIVE PAIN
3. THERE IS NO PACKING NECESSARY
4. THE PATIENT MAY RETURN TO WORK THE SAME DAY
5. THE HIGH COST OF HOSPITALIZATION & ANESTHESIA IS AVOIDED
6. THE METHOD IS RELIABLE
7. IT GIVES PRECISION TISSUE COAGULATION
8. IT MAY BE REPEATED IN 10 MINUTES IF NECESSARY; HOWEVER, THE AUTHOR HAS NOT FOUND IT NECESSARY TO DATE
9. THE BAYONET MOUNT ALLOWS GOOD VISUALIZATION DURING SURGERY W/ PRECISION HANDLING
10. IT IS SAFE & EFFECTIVE IN CHILDREN W/ CHRONIC TURBINATE HYPERTROPHY & CHRONIC RHINORRHEA. CHRONIC NASAL AIRWAY OBSTRUCTION IN CHILDREN CAN INTERFERE W/ MAXILLARY & MANDIBULAR DEVELOPMENT. OPENING THE NASAL AIRWAY IN CHRONICALLY OBSTRUCTED CHILDREN CAN REDUCE THE SYMPTOMS OF ALLERGY & IN SOME CASES REDUCE THE NEED FOR ALLERGY SHOTS.

THE COMPLETE SYSTEM

ITEM NO.	DESCRIPTION
5985	<u>ELMED SYSTEM FOR BIPOLAR SUBMUCOSAL TURBINATE SURGERY</u> CONSISTING OF: ITEM NO. 5356 ELMED BC 50 GENERATOR, ITEM NO. 5970 DENNIS TURBINATE PROBE, ITEM NO. 5707 FOOTSWITCH, ITEM NO. 5302 BIPOLAR RF-CABLE, ITEM NO. 55200-03 STERILIZATION AND STORAGE CASE AND ITEM NO. 5975 INSTRUCTIONAL VIDEO
ITEM NO.	DESCRIPTION
5970	DENNIS BIPOLAR SUBMUCOSAL TURBINATE PROBE
5302	BIPOLAR RF-CABLE FOR ELMED DENNIS PROBE & ELMED GENERATOR CONNECTION
5230	BIPOLAR RF-CABLE FOR ELMED DENNIS PROBE & GENERATORS W/ 2- BANANA PLUG CONNECTION
5975	VIDEO TAPE FEATURING BIPOLAR SUBMUCOSAL TURBINATE SURGERY BY DONALD DENNIS, M.D.
55200-03	ELMED STERILIZATION AND STORAGE CONTAINER FOR MULTIPLE INSTRUMENTS (OR SINUS SCOPES), ALONG WITH RF-CABLES; MADE OF DURABLE THERMOPLASTIC, PERFORATED, W/ SILICONE STRIP MOUNTING BARS, 11" x 7" x 1 1/2" (ILLUSTRATED)

IMPORTANT:

IN ORDER TO OBTAIN CLINICALLY SATISFACTORY RESULTS, COMBINED WITH THE ULTIMATE IN SAFETY FOR BOTH PATIENT AND SURGEON, THE DENNIS PROBE MUST BE ENERGIZED WITH AN APPROPRIATE LOW VOLTAGE BIPOLAR CURRENT. DISSATISFACTION AND FAILURES IN CLINICAL RESULTS CAN BE TRACED TO THE USE OF THE PROBE WITH GENERATORS DELIVERING OUTPUT WITH TOO HIGH A VOLTAGE OR A MODULATED WAVEFORM. THE ELMED BC 50 IS THE IDEAL BIPOLAR COAGULATOR FOR SUBMUCOSAL TURBINATE SURGERY, DELIVERING THE REQUIRED LOW VOLTAGE OUTPUT AND OPTIMUM OPERATING FREQUENCY, ASSURING CONSISTENTLY REPRODUCIBLE RESULTS.

SINCE THERE IS NO STANDARD FOR BIPOLAR GENERATORS WITH RESPECT TO OUTPUT WAVEFORM AND PEAK-TO-PEAK VOLTAGE, WE MUST DRAW YOUR ATTENTION TO THE FOLLOWING REQUIREMENTS FOR BIPOLAR SUBMUCOSAL TURBINATE SURGERY:

OUTPUT FREQUENCY- 500 KHZ, NOMINAL

WAVEFORM-FULL WAVE RECTIFIED (SINUSOIDAL, NON-MODULATED)

PEAK-TO PEAK VOLTAGE- NEVER TO EXCEED 400 V AT MAXIMUM GENERATOR OUTPUT. OPERATING VOLTAGE SHOULD BE LESS THAN 100 V PEAK-TO-PEAK AT NOMINAL SETTINGS. THIS IS VERY IMPORTANT, AS THE SURGICAL PROCEDURE IS TO DEHYDRATE THE TISSUE AND NOT BURN OR CHAR, OVERHEAT AND /OR ARC ACROSS IT. SINCE MOST BIPOLAR GENERATORS, PARTICULARLY THOSE INCORPORATED IN MAJOR OPERATING ROOM UNITS, MAY BE ENERGIZED BY HIGH VOLTAGE, MODULATED CURRENT, THERE IS DANGER OF POST OPERATIVE BLEEDING, EXCESSIVE TISSUE TRAUMA, OR OTHER COMPLICATIONS

ISOLATION FACTOR- THE BIPOLAR GENERATOR MUST BE ISOLATED FROM GROUND (FLOATING) WITH A MINIMUM ISOLATION FACTOR OF 98%

WATTAGE- REQUIREMENTS FOR THE INSTRUMENT RANGE FROM 15 TO 25 W. A SUITABLE BIPOLAR GENERATOR SHOULD HAVE A MAXIMUM OF NO MORE THAN 50 W OF POWER, MEASURED AT 100 OHM IMPEDANCE LOAD.



BIPOLAR ELECTROSURGICAL ACCESSORIES FOR ENT



MADE IN THE USA

BIPOLAR COAGULATION/DISSECTION FORCEPS FOR TONSILLECTOMY



ITEM No.	DESCRIPTION
5901-92	BAYONET BIPOLAR FORCEPS: FOOT SWITCHING, ANGLED BLUNT TIP (2MM), 2-PIN FITTING, 20CM LONG
5901-93	BAYONET BIPOLAR FORCEPS: FOOT SWITCHING, ANGLED POINTED TIP (5MM), 2-PIN FITTING, 20CM LONG

AESCLAP/DAVOL/
MARINA 2-PIN INST.
PLUG

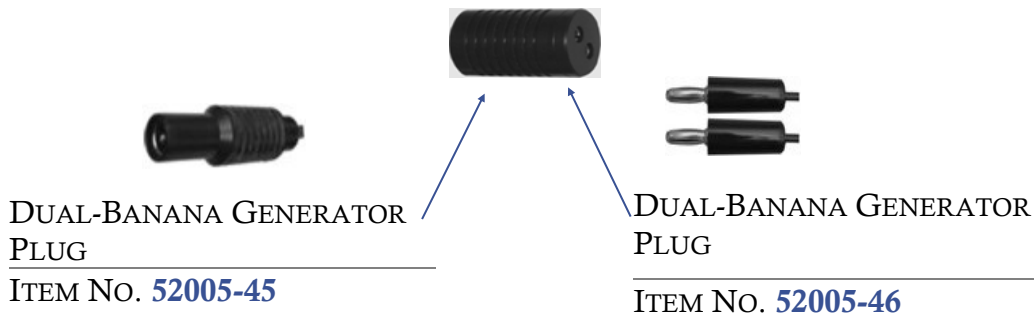

**SELECT BIPOLAR CABLE FOR THIS INSTRUMENT BASED ON THE GENERATOR YOU WILL BE USING



ITEM No.	DESCRIPTION
5971	BIPOLAR DUAL-NEEDLE COAGULATION PROBE, 2-PIN

REUSABLE ACCESSORIES FOR BIPOLAR SUCTION/IRRIGATION & COAGULATION



ITEM No.	DESCRIPTION
5980	ELMED BIPOLAR COAGULATOR: W/ SUCTION/IRRIGATION CHANNEL
5981	ELMED BIPOLAR COAGULATOR: FOR SUCTION & IRRIGATION W/ DUAL STOPCOCK



BIPOLAR ELECTROSURGICAL ACCESSORIES FOR ENT



MADE IN THE USA

BIPOLAR SURGICAL CUT-COAG SCISSORS

FEATURES:

- REUSABLE INSTRUMENT, MAKING IT VERY COST EFFECTIVE
- AUTOCLAVABLE BY ALL MODALITIES
- EACH BLADE CAN BE SEPARATED & SHARPENED, NO REINSULATING COSTS
- HEAVY DUTY INSULATION FOR DURABILITY & EASY CLEANING
- SYMMETRICAL COAGULATION BY WHICH A CONSTANT (SYMMETRICAL) CURRENT FLOW THROUGH BOTH OF THE SCISSOR BLADES, THIS ASSURES AN EQUAL COAGULATION ON BOTH SCISSOR BLADE POLES.



TIP STYLE A:
STANDARD BLADE, 1/2
OUTSIDE BLADE HEAVY
DUTY SYNTHETIC BLUE
INSULATION



TIP STYLE A:
STANDARD BLADE 3/4
OUTSIDE BLADE, HEAVY
DUTY SYNTHETIC BLUE
INSULATION

ITEM NO.	DESCRIPTION
5950-18	CURVED METZENBAUM 18CM (7")
5950-21	CURVED METZENBAUM, 21CM (8.25")
5950-23	CURVED METZENBAUM, 23CM (9")
5950-28	CURVED METZENBAUM, 28CM (11")

ITEM NO.	DESCRIPTION
5960-18	CURVED METZENBAUM, 18CM (7")
5960-21	CURVED METZENBAUM, 21CM (8.25")
5960-23	CURVED METZENBAUM, 23CM (9")
5960-28	CURVED METZENBAUM, 28CM (11")

ELMED/WOLF
GENERATOR PLUG

ITEM No. 52005-21

DUAL BANANA
GENERATOR PLUG

ITEM No. 52005-22





SPECIALTY SINUS INSTRUMENTS



MADE IN THE USA

FIBER OPTIC AUFRICHT RETRACTOR W/



ITEM NO.	DESCRIPTION
37045-18F	FIBER OPTIC AUFRICHT NASAL RETRACTOR, 10MM X 30MM BLADE
37046-18F	FIBER OPTIC AUFRICHT NASAL RETRACTOR, 10MM X 45MM BLADE
37047-18F	FIBER OPTIC AUFRICHT NASAL RETRACTOR, 10MM X 60MM BLADE



*OPTIONAL CABLE ADAPTERS

ITEM NO.	DESCRIPTION
9881	WOLF/DYONICS ADAPTER
9882	STORZ/OLYMPUS ADAPTER

SINUS ENDOSCOPIC CLIP APPLIER



- REUSABLE CLIP APPLIER FOR SMALL & MEDIUM TITANIUM CLIPS
- SMALL DIAMETER & TWO SHORT SHAFT LENGTHS FOR ENHANCED SINUS SURGERY
- ROTATING 360° REUSABLE OPEN SURGERY CLIP APPLIER W/ ERGONOMIC HANDLE

AVAILABLE IN 2 ROTATING STYLES:

- ONE PIECE HANDLE & SHAFT W/ REMOVABLE INSERT
- 3-PIECE MODULAR-TAKE-APART. HANDLE, SHAFT & INSERT



SMALL TIP FOR SMALL CLIPS



MEDIUM TIP FOR SMALL CLIPS

ITEM NO.	WORKING LENGTH SHAFT	2-PIECE	3-PIECE MODULAR
36500-18A	7 INCHES	YES	NO
36500-18B	7 INCHES	NO	YES
36500-22A	9 INCHES	YES	NO
36500-22B	9 INCHES	NO	YES

ITEM NO.	WORKING LENGTH SHAFT	2-PIECE	3-PIECE MODULAR
36600-18A	7 INCHES	YES	NO
36600-18B	7 INCHES	NO	YES
36600-22A	9 INCHES	YES	NO
36600-22B	9 INCHES	NO	YES

ITEM NO.	DESCRIPTION
E174CS6	SMALL STERILE TITANIUM CLIP (QTY. 120)
E174CM6	MEDIUM STERILE TITANIUM CLIP (QTY. 120)



SCOPES, LIGHT SOURCES & HEADLIGHTS FOR ENT



MADE IN THE USA

ELMED EOS™ HD OTOSCOPES

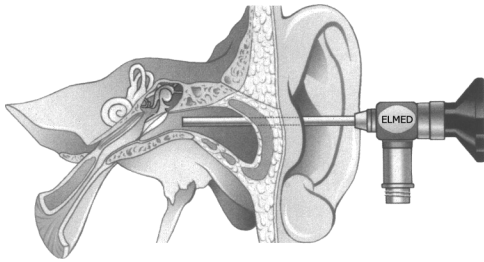
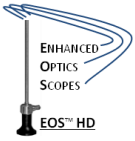

FEATURES:

- IDEAL FOR THE OVERVIEW OF THE ENTIRE EARDRUM
- THE WIDE ANGLE LENS ENABLES A NATURAL, UNDISTORTED, PANORAMIC OVERVIEW OF THE COMPLETE EARDRUM
- CLEAR, BRIGHT, & EXTREMELY SHARP PICTURE W/ HIGH RESOLUTION & SHARPNESS IN DEPTH
- SNAP ON ADAPTOR ACCEPTS WELCH/ALLYN DISPOSABLE SPECULA #52434 OR #52133
- LIGHT POST FITTING, ACMI: ADAPTERS AVAILABLE FOR WOLF OR STORZ/OLYMPUS
- COMPLETELY REUSABLE & FULLY AUTOCLAVABLE
- 100% GERMAN ROD LENS SYSTEM

ITEM NO.	DESCRIPTION
36400-00	EOS HD, 4MM Ø, 6CM W.L., 0° VIEWING
36400-30	EOS HD 4MM Ø, 6CM W.L., 30° VIEWING
36290-100	EOS HD 2.9MM Ø, 6CM W.L., 0° VIEWING
36290-130	EOS HD 2.9MM Ø, 6CM W.L., 30° VIEWING
36290-145	EOS HD 2.9MM Ø, 6CM W.L., 45° VIEWING
36290-170	EOS HD 2.9MM Ø, 6CM W.L., 70° VIEWING
36190-00	EOS HD 1.9MM Ø, 10CM W.L., 0° VIEWING
36190-30	EOS HD 1.9MM Ø, 10CM W.L., 30° VIEWING
36190-70	EOS HD 1.9MM Ø, 10CM W.L., 70° VIEWING



ITEM NO.	DESCRIPTION
36400-50	SNAP-ON ADAPTOR FOR WELCH/ALLYN DISPOSABLE SPECULA #52434 & 52133, FOR OTOSCOPE #36400-00 & 36400-30
36290-50	SNAP-ON ADAPTOR FOR WELCH/ALLYN DISPOSABLE SPECULA #52434 & 52133, FOR OTOSCOPE #36290-00 & 36290-30, 36290-45, 36290-70
36190-50	SNAP-ON ADAPTOR FOR WELCH/ALLYN DISPOSABLE SPECULA #52434 & 52133, FOR OTOSCOPE #36190-00 & 36190-30, 36190-45, 36190-70
36500-01	PNEUMATIC ADAPTOR FOR BRUENING FOR SPECULUMS SIZE 00-4, INCLUDING RUBBER BALL W/ TUBE & CONE FOR USE W/ OTOSCOPE 36290-00 -> 36290-70
36500-02	BRIDGE FOR PNEUMATIC ADAPTER FOR USE W/ OTOSCOPE 36400-00 & 36400-30 W/ BRUENING EAR SPECULUM SIZE 00-4
36290-60	GUIDING SHEATH FOR LASER PROBES, ROTATABLE FOR OTOSCOPE 36290-00
26290-61	GUIDING SHEATH FOR LASER PROBES, ROTATABLE FOR OTOSCOPE 36290-30



SCOPES, LIGHT SOURCES & HEADLIGHTS FOR ENT



MADE IN THE USA

ELMED EOS™ HD VIDEO OTOSCOPES



ITEM NO.	DESCRIPTION
36-2700	2.7MM, 0°, FOCUSABLE, W/ C-MOUNT THREAD FOR DIRECT COUPLING TO CAMERA HEAD
36-0400	4.0MM, 0°, FOCUSABLE, W/ C-MOUNT THREAD FOR DIRECT COUPLING TO CAMERA HEAD
36-2799	2.9MM, 0°, W/OUT FOCUS, W/ EYEPIECE FOR CONNECTION TO TV COUPLER
36-0499	4.0MM, 0°, W/OUT FOCUS, W/ EYEPIECE FOR CONNECTION TO TV COUPLER

ELMED ES™ SINUS SCOPES

FEATURES:

- MADE WITH PREMIUM AMERICAN OPTICAL LENS SYSTEMS
- GLASS FIBER-LIGHT CONE FOR BRIGHT PICTURE
- FULLY AUTOCLAVABLE BY ALL STANDARD STERILIZATION METHODS
- STORZ TYPE SLEEVE LOCK (OTHER AVAILABLE UPON REQUEST)
- STANDARD TYPE ACMI LIGHT POST W/ WOLF STORZ ADAPTERS
- ONE YEAR WARRANTY ON MATERIAL & WORKMANSHIP



ITEM NO.	DESCRIPTION
37400-100	ELMED ES™ SINUS SCOPE: 4MM Ø, 0° VIEWING
37400-130	ELMED ES™ SINUS SCOPE: 4MM Ø, 30° VIEWING
37400-145	ELMED ES™ SINUS SCOPE: 4MM Ø, 45° VIEWING
37400-170	ELMED ES™ SINUS SCOPE: 4MM Ø, 70° VIEWING



SCOPES, LIGHT SOURCES & HEADLIGHTS FOR ENT



MADE IN THE USA

ELMED EOS™ HD PARANASAL SINUS SCOPES

FEATURES:

- MADE WITH PREMIUM GERMAN OPTICAL LENS SYSTEM
- GLASS FIBER-LIGHT CONE FOR BRIGHT PICTURE
- FULLY AUTOCLAVABLE BY ALL STANDARD STERILIZATION METHODS
- STORZ-TYPE SLEEVE LOCK (OTHERS AVAILABLE UPON REQUEST)
- STANDARD TYPE ACMI LIGHT POST W/ WOLF STORZ ADAPTORS
- ONE YEAR WARRANTY ON MATERIAL & WORKMANSHIP

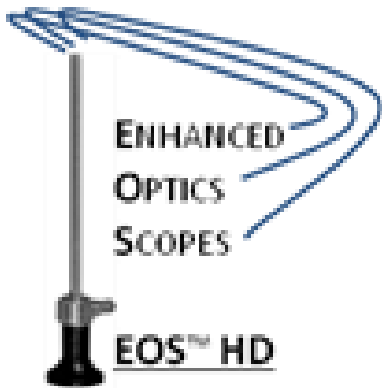

ITEM NO.	DESCRIPTION
37270-00	ELMED EOS™ HD SINUS SCOPE: 2.7MM Ø, 0° VIEWING
37270-30	ELMED EOS™ HD SINUS SCOPE: 2.7MM Ø, 30° VIEWING
37270-45	ELMED EOS™ HD SINUS SCOPE: 2.7MM Ø, 45° VIEWING
37270-70	ELMED EOS™ HD SINUS SCOPE: 2.7MM Ø, 70° VIEWING
37290-00	ELMED EOS™ HD SINUS SCOPE: 2.9MM Ø, 0° VIEWING
37290-30	ELMED EOS™ HD SINUS SCOPE: 2.9MM Ø, 30° VIEWING
37290-45	ELMED EOS™ HD SINUS SCOPE: 2.9MM Ø, 45° VIEWING
37290-70	ELMED EOS™ HD SINUS SCOPE: 2.9MM Ø, 70° VIEWING
37400-00	ELMED EOS™ HD SINUS SCOPE: 4.0MM Ø, 0° VIEWING
37400-30	ELMED EOS™ HD SINUS SCOPE: 4.0MM Ø, 30° VIEWING
37400-45	ELMED EOS™ HD SINUS SCOPE: 4.0MM Ø, 45° VIEWING
37400-70	ELMED EOS™ HD SINUS SCOPE: 4.0MM Ø, 70° VIEWING



SCOPES, LIGHT SOURCES & HEADLIGHTS FOR ENT



MADE IN THE USA

ELMED LED LIGHT SOURCES



ITEM NO.	DESCRIPTION
98-2000	ELMED LED 2000 LIGHT SOURCE W/ (4) PORT LIGHT TURRET (ACMI, WOLF, STORZ, & OLYMPUS)

ITEM NO.	DESCRIPTION
98-3000	ELMED LED 3000 LIGHTSOURCE W/ (4) PORT LIGHT TURRET (ACMI, WOLF, STORZ, & OLYMPUS)

FEATURES:

- BRIGHT WHITE LIGHT OUTPUT
- COMPARABLE TO MOST 250W HALOGEN & 180W XENON LIGHT SOURCES
- EXPECTED LED LIFE OF 30,000 HOURS
- THE LIGHT PORT ALSO INCLUDES A SENSOR TO DETERMINE IF THE FIBER-OPTIC CABLE IS INSERTED, IF NOT IT GOES INTO STANDBY MODE W/ LED POWERED DOWN.
- INCLUDES INTEGRAL SOFTWARE CONTROLS FOR THERMAL MANAGEMENT, DIMMING CONTROL (ANALOG OR PWM), & PROVIDING FEEDBACK ON LED & ELECTRONICS TEMPERATURE & FAN SPEED



ELMED HANDY III™ PORTABLE LED LIGHT SOURCE W/ RECHARGEABLE

ITEM NO.	DESCRIPTION
9809-02	ELMED HANDY III PORTABLE LED LIGHT-SOURCE W/ RECHARGEABLE BATTERY
9809-02-01	RECHARGEABLE LITHIUM BATTERY 3.7V



FEATURES:

- POWERFUL FOCUSED 3W LED ELEMENT, PROVIDES MORE ILLUMINATION THAN COMPETITORS, DUE TO OUR INCORPORATED SUPER MAGNIFYING LENS &
- CUTTING EDGE TECHNOLOGY
- LONGER BATTERY LIFE & MORE LIGHT OUTPUT DUE TO THE SMALL 3W LED ELEMENT, WHICH CONSUMES A LOT LESS POWER THAN A HALOGEN LAMP
- STAINLESS STEEL
- AVERAGE ILLUMINATION- 28,000-46,000 LUX
- WIDE APPLICATION AS A PORTABLE LIGHT SOURCE FOR ENDOSCOPES, OTOSCOPES, BORESCOPES, FLEXIBLE SCOPES & FIBER-OPTIC HEADLIGHTS



SCOPES, LIGHT SOURCES & HEADLIGHTS FOR ENT



MADE IN THE USA

ELMED LITE ONE™ 300W XENON LIGHT SOURCE

ITEM NO.	DESCRIPTION
9810	ELMED LITE ONE™ 300W LIGHT SOURCE W/ (4) PORT LIGHT TURRET (ACMI, WOLF, STORZ, & OLYMPUS)



FEATURES:

- BRILLIANT DAYLIGHT QUALITY LIGHT
- INTEGRATED, DUAL-FAN POWERED DUCTED COOLING SYSTEM FOR COOL RUNNING EXTENDED LIFE CYCLE FOR ALL INTERNAL COMPONENTS
- ALL-STEEL CONSTRUCTED FRAME AND CABINET FOR GREATER DURABILITY AND LESS HEAT TRANSFER
- FRONT PANEL CONTROLS: ON/OFF SWITCH, POSITIVE CONTROL VARIABLE INTENSITY SELECTOR, RESET BULB METER, EASY-TO-IDENTIFY & MANIPULATE 4-PORT LIGHT TURRET
- DETACHABLE AC LINE CORD FOR EASIER TRANSPORTATION
- EXTERNAL MAIN FUSE ACCESSIBLE ON REAR PANEL

ELMED HALOGEN LIGHT SOURCES

ELMED LS150 II HALOGEN LIGHT SOURCES

ITEM NO.	DESCRIPTION
9806	ELMED LS150 II HALOGEN LIGHT SOURCE W/ DUAL 150W QUARTZ HALOGEN LAMP & 3-PORT SLIDE BAR FOR EACH BULB (ACMI, STORZ, WOLF)



FEATURES:

- LOW VOLTAGE, DUAL 24V 150W QUARTZ HALOGEN BULBS & POWER SOURCE, PROVIDING COOL LIGHT FOR LONG PERIODS OF APPLICATION, EXTENDING BULB LIFE TO MAXIMUM LIFE CYCLE
- DUAL LAMPS – SECOND BULB SERVES AS ENERGY BACKUP WHEN SWITCHING BULBS IN A HURRY IS REQUIRED; ACTIVATED BY FRONT PANEL MOUNTED SWITCH
- ALL CONTROLS ARE FRONT PANEL MOUNTED, FOR SIMPLE OPERATION
- SIMPLE BULB REPLACEMENT BY SLIDING BULB COMPARTMENT RACK ON FRONT PANEL
- EXTERNAL MAIN FUSE ACCESSIBLE ON REAR PANEL

ELMED OL160 II HALOGEN LIGHT SOURCES

ITEM NO.	DESCRIPTION
9812	SINGLE 150W QUARTZ HALOGEN LAMP & SINGLE ACMI LIGHT PORT
9812T	SINGLE 150W QUARTZ HALOGEN LAMP & 4-POST TURRET (ACMI, STORZ, WOLF & OLYMPUS)



FEATURES:

- BRIGHT, LONG LASTING 150 WATTAGE POWER
- STANDARD ACMI CABLE CONNECTION OUTLET
- COOLING RUNNING FAN
- COMPACT SIZE: 7 1/2" x 7" x 4"
- CARRYING HANDLE AVAILABLE (SPECIFY WHEN ORDERING)

ELMED 5MM DIA. FIBER LIGHT BUNDLE LIGHT CABLES

ITEM NO.	DESCRIPTION
9819	ELMED FIBER-LIGHT CABLE W/ ACMI INSTRUMENT & LIGHT SOURCE CONNECTORS*
9820	ELMED FIBER-LIGHT CABLE W/ UNIVERSAL INSTRUMENT & LIGHT SOURCE CONNECTORS*





SCOPES, LIGHT SOURCES & HEADLIGHTS FOR ENT



MADE IN THE USA

ELMED LED HEADLIGHT SYSTEM

ITEM No.	DESCRIPTION
9850	ELMED LED 3 HEADLIGHT SYSTEM W/ ADJUSTABLE HEADBAND, PORTABLE BATTERY PACK, CHARGER AND CARRYING CASE



FEATURES:

- BRILLIANT WHITE LIGHT REMAINS CONSTANT AT 2,000 FOOT CANDLES FOR 7+HRS.
- VARIABLE INTENSITY TO 4,500 FOOT CANDLES.
- LITHIUM ION RECHARGEABLE BELT CLIP BATTERY PACK STORES CHARGE FOR 7+HRS.
- UNIVERSAL CHARGER OPERATES IN 100V-240V
- LIGHT WEIGHT OPTIC WITH VERTICAL POSITIONING AND EXCEPTIONAL COAXIAL ALIGNMENT.
- OUR LIGHTEST SYSTEM – OPTIC AND HEADBAND WEIGH ONLY .4OUNCES PROVIDING COMFORTABLE WEAR FOR EXTENDED PERIODS.
- COMFORTABLE, HEAVY DUTY MULTIPLE HEADBAND FEATURES SPECIAL PADDED CUSHIONS, WHICH ELIMINATE PRESSURE POINTS AND A RATCHET MECHANISM FOR ADJUSTMENTS.

ELMED FIBER OPTIC HEADLIGHT SYSTEM

ITEM No.	DESCRIPTION
9800	ELMED FIBEROPTIC HEADLIGHT WITH ADJUSTABLE HEADBAND 7' FIBER LIGHT CONNECTION CABLE W/ ACMI CONNECTOR (ILLUSTRATED)
9800-1	ELMED FIBEROPTIC HEADLIGHT WITH ADJUSTABLE HEADBAND 10' FIBER LIGHT CONNECTION CABLE W/ ACMI CONNECTOR (ILLUSTRATED)



FEATURES:

- BRILLIANT WHITE LIGHT REMAINS CONSTANT AT 2,000 FOOT CANDLES FOR 7+HRS.
- VARIABLE INTENSITY TO 4,500 FOOT CANDLES.
- LITHIUM ION RECHARGEABLE BELT CLIP BATTERY PACK STORES CHARGE FOR 7+HRS.
- UNIVERSAL CHARGER OPERATES IN 100V-240V
- LIGHT WEIGHT OPTIC WITH VERTICAL POSITIONING AND EXCEPTIONAL COAXIAL ALIGNMENT.
- OUR LIGHTEST SYSTEM – OPTIC AND HEADBAND WEIGH ONLY .4OUNCES PROVIDING COMFORTABLE WEAR FOR EXTENDED PERIODS.
- COMFORTABLE, HEAVY DUTY MULTIPLE HEADBAND FEATURES SPECIAL PADDED CUSHIONS, WHICH ELIMINATE PRESSURE POINTS AND A RATCHET MECHANISM FOR ADJUSTMENTS.
- CLIPS AVAILABLE FOR ALL MAJOR TTL AND FLIP UP LOUPES

ELMED HALOGEN HEADLIGHT SYSTEM

ITEM No.	DESCRIPTION
9840	SYSTEM INCLUDES: HEADLIGHT, RECHARGEABLE ECOPAC BATTERY PACK, BATTERY CHARGER, TRANSFORMER, SPARE HALOGEN BULB AND CARRYING CASE
9825	ELMED HALOGEN HEADLAMP: ADJUSTABLE HEADBAND, HALOGEN LAMP/MIRROR SYSTEM & SUPPLY CABLE



FEATURES:

- BRILLIANT ILLUMINATION THAT REMAINS CONSTANT AT 2,000 FOOT CANDLES FOR THE LIFE OF THE LAMP (APP. 100 HOURS)
- RECHARGEABLE BATTERY PACK TO BE WORN ON THE PHYSICIAN'S BELT; No. 9897 WILL PROVIDE POWER FOR TWO HOURS OF CONTINUOUS USE
- THE OPTIONAL MONOCULAR OPTIC PROVIDES COAXIAL ILLUMINATION FOR COMPLETELY SHADOW LESS VIEWING.
- ADJUSTABLE SPOT SIZE, CONTINUOUSLY VARIABLE FROM A 750MM TO A 120MM FIELD, MEASURED AT A DISTANCE OF 13". THE UNIFORM ROUND SPOT MINIMIZES REFLECTIVE GLARE INSIDE SMALLER CAVITIES
- EASILY ACCESSIBLE LARGE ON/OFF PUSH-BUTTON SWITCH ALLOWS THE PHYSICIAN TO SWITCH OFF THE SYSTEM, THUS REDUCING HEAT BUILD-UP AND INCREASING BATTERY LIFE
- THE HEADBAND FEATURES SPECIAL PADDED CUSHIONS, WHICH ELIMINATE PRESSURE POINTS, AND A RATCHET MECHANISM FOR ADJUSTING IT TO THE INDIVIDUAL HEAD SIZE



FESS SINUSCOPY INSTRUMENTS



MADE IN THE USA

FORCEPS

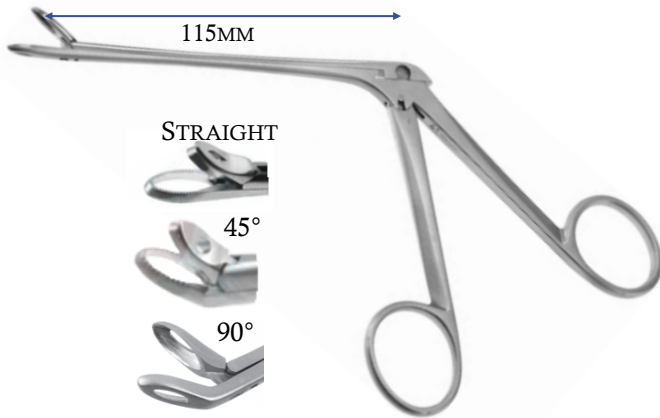

ITEM NO.	DESCRIPTION
37001-25	WEIL-BLAKESLEY, STRAIGHT, 2.5MM BITE
37001-30	WEIL-BLAKESLEY, STRAIGHT, 3.0MM BITE
37001-36	WEIL-BLAKESLEY, STRAIGHT, 3.6MM BITE
37001-40	WEIL-BLAKESLEY, STRAIGHT, 4.0MM BITE
37001-50	WEIL-BLAKESLEY, STRAIGHT, 5.0MM BITE
37002-25	WEIL-BLAKESLEY, 45° UP-CURVED, 2.5MM BITE
37002-30	WEIL-BLAKESLEY, 45° UP-CURVED, 3.0MM BITE
37002-36	WEIL-BLAKESLEY, 45° UP-CURVED, 3.6MM BITE
37002-40	WEIL-BLAKESLEY, 45° UP-CURVED, 4.0MM BITE
37002-50	WEIL-BLAKESLEY, 45° UP-CURVED, 5.0MM BITE
37003-25	WEIL-BLAKESLEY, 90° UP-CURVED, 2.5MM BITE
37003-30	WEIL-BLAKESLEY, 90° UP-CURVED, 3.0MM BITE
37003-36	WEIL-BLAKESLEY, 90° UP-CURVED, 3.6 MM BITE

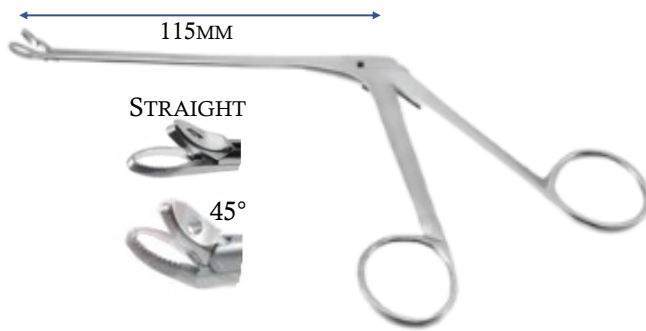

37004-25	WEIL-BLAKESLEY, THRU CUT, STRAIGHT, 2.5MM BITE
37004-36	WEIL-BLAKESLEY, THRU CUT, STRAIGHT, 3.6MM BITE
37004-40	WEIL-BLAKESLEY, THRU CUT, STRAIGHT, 4.0MM BITE
37004-48	WEIL-BLAKESLEY, THRU CUT, STRAIGHT, 4.8MM BITE
37005-25	WEIL-BLAKESLEY, THRU CUT, 45° UP-CURVED, 2.5MM BITE
37005-36	WEIL-BLAKESLEY, THRU CUT, 45° UP-CURVED, 3.6MM BITE
37005-40	WEIL-BLAKESLEY, THRU CUT, 45° UP-CURVED, 4.0MM BITE
37005-48	WEIL-BLAKESLEY, THRU CUT, 45° UP-CURVED, 4.8MM BITE

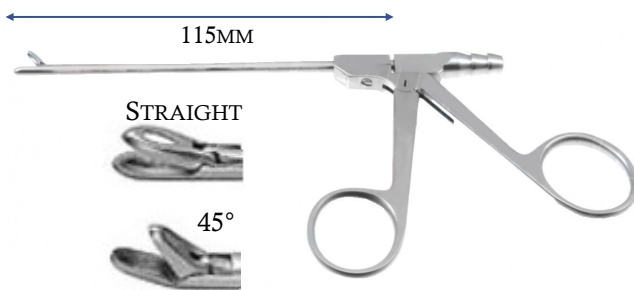

37021-25	WEIL-BLAKESLEY, STRAIGHT, 2.5MM BITE
37021-30	WEIL-BLAKESLEY, STRAIGHT, 3.0MM BITE
37021-36	WEIL-BLAKESLEY, STRAIGHT, 3.6MM BITE
37021-40	WEIL-BLAKESLEY, STRAIGHT, 4.0MM BITE
37021-50	WEIL-BLAKESLEY, STRAIGHT, 5.0MM BITE
37022-25	WEIL-BLAKESLEY, 45° UP-CURVED 2.5MM BITE
37022-30	WEIL-BLAKESLEY, 45° UP-CURVED, 3.0MM BITE
37022-36	WEIL-BLAKESLEY, 45° UP-CURVED, 3.6MM BITE
37022-40	WEIL-BLAKESLEY, 45° UP-CURVED, 4.0MM BITE
37022-50	WEIL-BLAKESLEY, 45° UP-CURVED, 5.0MM BITE

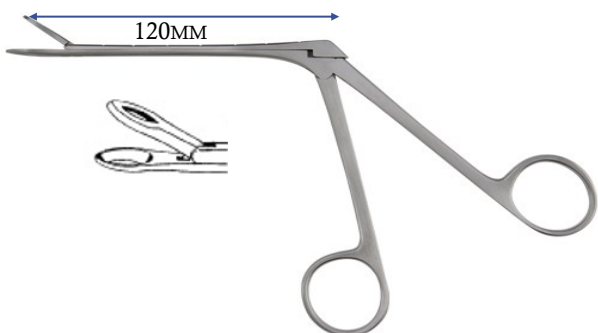

37006-45	TILLEY HENCKEL ETHMOID FORCEPS, STRAIGHT 4.5MM BITE
37006-55	TILLEY HENCKEL ETHMOID FORCEPS, STRAIGHT 5.5MM BITE
37006-65	TILLEY HENCKEL ETHMOID FORCEPS, STRAIGHT 6.5MM BITE
37006-80	TILLEY HENCKEL ETHMOID FORCEPS, STRAIGHT 8.0MM BITE



FESS SINUSCOPY INSTRUMENTS



MADE IN THE USA

PUNCHES

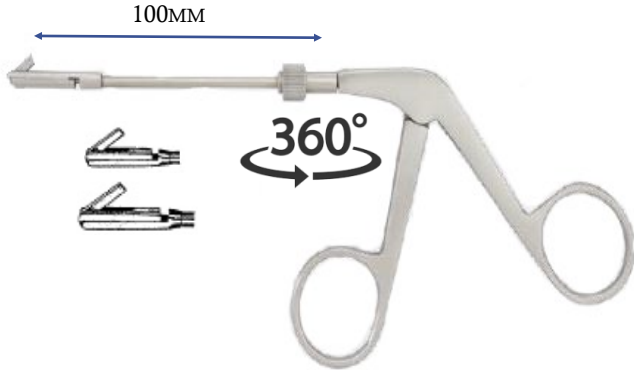

ITEM NO.	DESCRIPTION
37007-15	RETRO ANTRUM PUNCH, 360° ROTATABLE, 1.5MM BITE
37007-20	RETRO ANTRUM PUNCH, 360° ROTATABLE, 2.0MM BITE

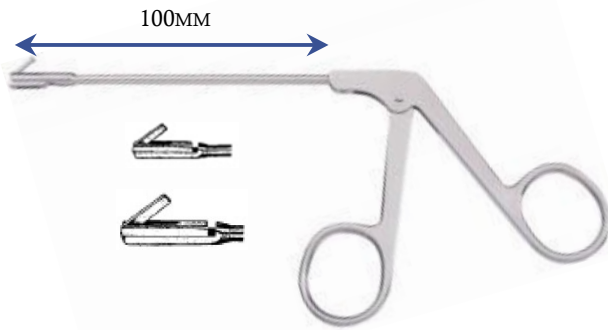

37008-15	OSTRUM-STANNBERGER PEDIATRIC "BACKBITER" ANTRUM PUNCH, 1.5MM BITE
37009-15	OSTRUM-STANNBERGER PEDIATRIC "BACKBITER" ANTRUM PUNCH, LEFT-SIDE CUTTING, 1.5MM BITE
37010-15	OSTRUM-STANNBERGER PEDIATRIC "BACKBITER" ANTRUM PUNCH, RIGHT-SIDE CUTTING, 1.5MM BITE
37011-20	OSTRUM-STANNBERGER STANDARD "BACKBITER" ANTRUM PUNCH, 2.0MM BITE
37012-20	OSTRUM-STANNBERGER STANDARD "BACKBITER" ANTRUM PUNCH, LEFT-SIDE CUTTING, 2.0MM BITE
37013-20	OSTRUM-STANNBERGER STANDARD "BACKBITER" ANTRUM PUNCH, RIGHT-SIDE CUTTING, 2.0MM BITE

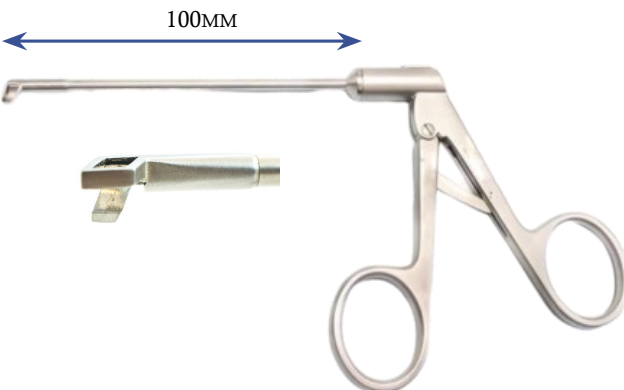

37015-25	SIDE BITING, LEFT, ANTRUM PUNCH, THROUGH CUTTING, STANDARD PATTERN, 2.5MM X 4MM BITE
37015-35	SIDE BITING, RIGHT, ANTRUM PUNCH, THROUGH CUTTING, STANDARD PATTERN, 2.5MM X 4MM BITE
37017-25	SIDE BITING, LEFT, ANTRUM PUNCH, THROUGH CUTTING, STANDARD PATTERN, 3.5MM X 4MM BITE
37017-35	SIDE BITING, RIGHT, ANTRUM PUNCH, THROUGH CUTTING, STANDARD PATTERN, 3.5MM X 4MM BITE



FESS SINUSCOPY INSTRUMENTS



MADE IN THE USA

SINUS FORCEPS & SCISSORS

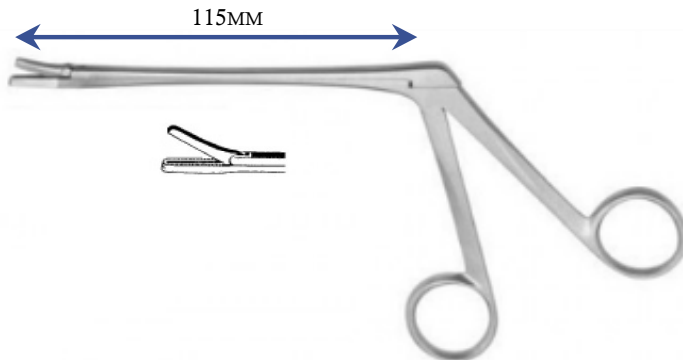

ITEM NO.	DESCRIPTION
37240-19	STRUYCKEN NASAL CUTTING FORCEPS, THROUGH CUTTING, 1.0MM CUT
37241-19	STRUYCKEN NASAL CUTTING FORCEPS, THROUGH CUTTING, 1.5MM CUT

ITEM NO.	DESCRIPTION
37025-01	NASAL SCISSORS, STRAIGHT CURVED, W/ 10MM SERRATED BLADES
37025-03	NASAL SCISSORS, LEFT CURVED, W/ 10MM SERRATED BLADES
37025-04	NASAL SCISSORS, RIGHT CURVED, W/ 10MM SERRATED BLADES

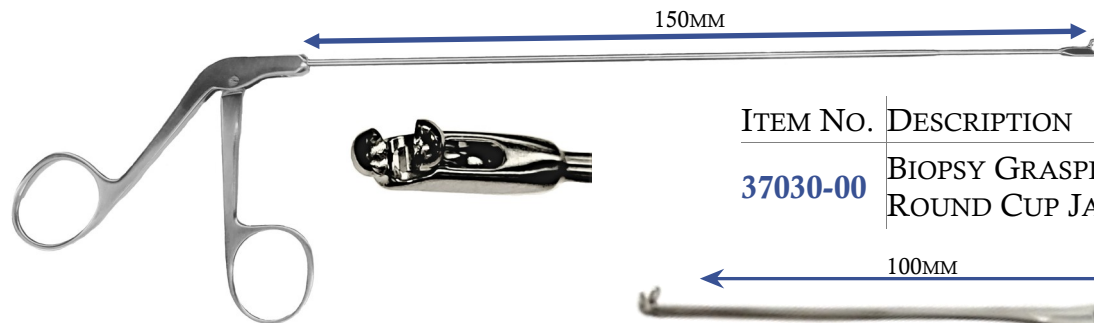
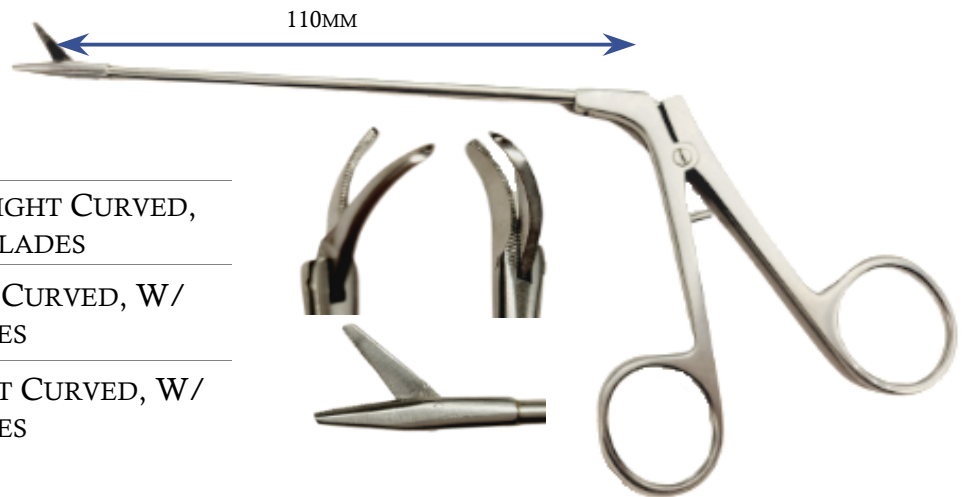

ITEM NO.	DESCRIPTION
37030-00	BIOPSY GRASPING FORCEPS W/ 3MM ROUND CUP JAWS, TUBULAR SHAFT

ITEM NO.	DESCRIPTION
37023-25	STRUBPEL (VCSS) PEDIATRIC SINUS FORCEPS, STRAIGHT, DELICATE, 2.5MM BITE
37023-45	STRUBPEL (VCSS) PEDIATRIC SINUS FORCEPS, 45° UP-CURVED, DELICATE, 2.5MM BITE
37023-90	STRUBPEL (VCSS) PEDIATRIC SINUS FORCEPS, 90° UP-TURNED, DELICATE, 2.5MM BITE

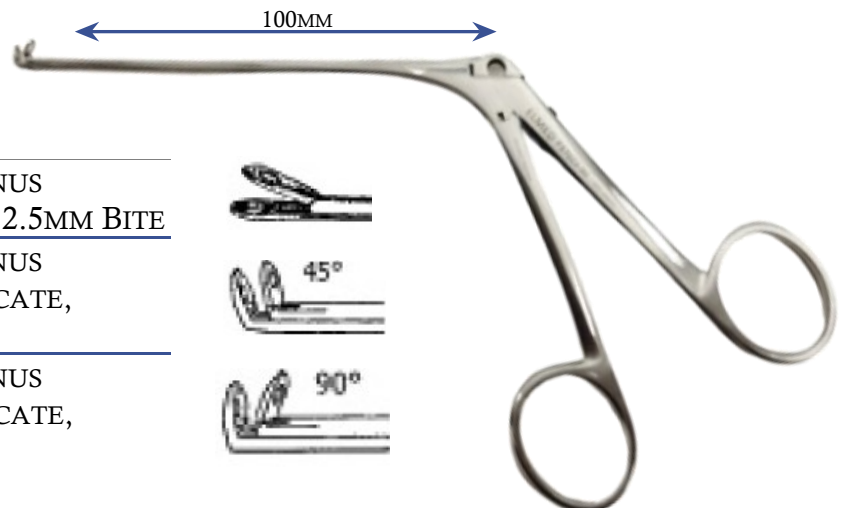



FESS SINUSCOPY INSTRUMENTS



MADE IN THE USA

SINUS FORCEPS & SCISSORS

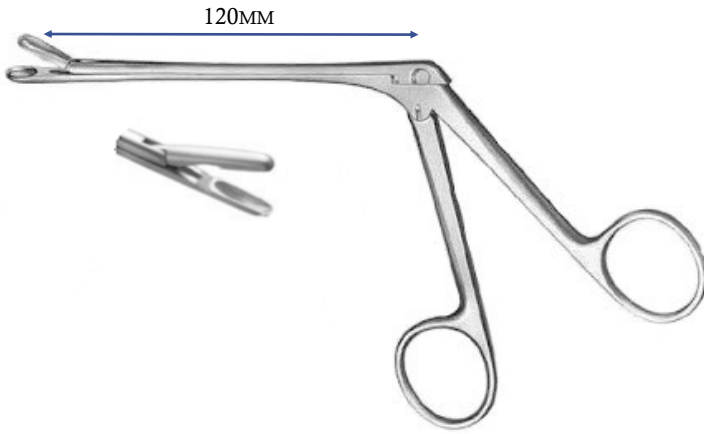

ITEM No.	DESCRIPTION
37242-00	TAKAHASI ETHMOID FORCEPS, STRAIGHT, 2.5MM BITE
37242-01	TAKAHASI ETHMOID FORCEPS, STRAIGHT, 4.0MM BITE
37423-00	TAKAHASI ETHMOID FORCEPS, 45° UP-CURVED, 2.5MM BITE
37243-01	TAKAHASI ETHMOID FORCEPS, 45° UP-CURVED, 4.0MM BITE

SINUSCOPY SUCTION TUBES

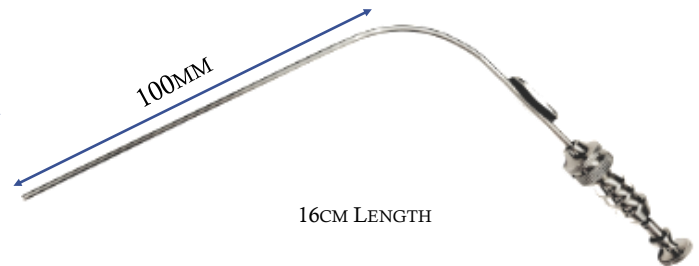

ITEM No.	DESCRIPTION
36042-06	FRAZIER SUCTION TUBE W/ FINGER VALVE & STILETTE (6FR)
36042-07	FRAZIER SUCTION TUBE W/ FINGER VALVE & STILETTE (7FR)
36042-08	FRAZIER SUCTION TUBE W/ FINGER VALVE & STILETTE (8FR)
36042-10	FRAZIER SUCTION TUBE W/ FINGER VALVE & STILETTE (10FR)
36042-12	FRAZIER SUCTION TUBE W/ FINGER VALVE & STILETTE (12FR)

ITEM No.	DESCRIPTION
36044-06	FERGUSON (FRAZIER) SUCTION TUBE, 75° ANGLED W/ FINGER VALVE & STILETTE (6FR)
36044-07	FERGUSON (FRAZIER) SUCTION TUBE, 75° ANGLED W/ FINGER VALVE & STILETTE (7FR)
36044-08	FERGUSON (FRAZIER) SUCTION TUBE, 75° ANGLED W/ FINGER VALVE & STILETTE (8FR)
36044-09	FERGUSON (FRAZIER) SUCTION TUBE, 75° ANGLED W/ FINGER VALVE & STILETTE (10FR)



ITEM No.	DESCRIPTION
37190-30	MAGILL SUCTION TUBE, 3.0MM DIA.
37190-35	MAGILL SUCTION TUBE, 3.5MM DIA.
37190-40	MAGILL SUCTION TUBE, 4.5MM DIA.



FESS SINUSCOPY INSTRUMENTS



MADE IN THE USA

SINUSCOPY TROCARS & CANNULAS

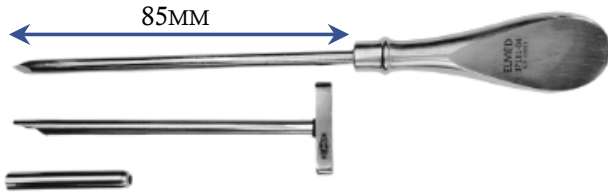

ITEM NO.	DESCRIPTION
37068-05	SINUS TROCAR & CANNULA W/ OBLIQUE TIP, 16CM, O.D. 5MM (FOR 4MM SCOPES)
37068-03	SINUS TROCAR & CANNULA W/ OBLIQUE TIP, 16CM, O.D. 3.5MM (FOR 2.9MM SCOPES)

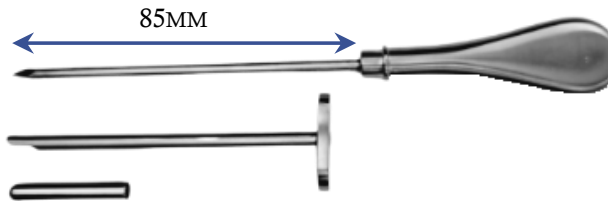

ITEM NO.	DESCRIPTION
37181-05	SINUS TROCAR & CANNULA W/ BALL-SHAPED TIP, 16CM, O.D. 5MM (FOR 4MM SCOPES)

EICKEN ANTRUM CANNULAS



REGULAR CURVE

ITEM NO.	DESCRIPTION
37185-25	EICKEN ANTRUM CANNULA, 14CM, 2.5MM DIA. (REGULAR CURVE)
37185-30	EICKEN ANTRUM CANNULA, 14CM, 3MM DIA. (REGULAR CURVE)
37185-40	EICKEN ANTRUM CANNULA, 14CM, 4MM DIA. (REGULAR CURVE)



SHORT CURVE

ITEM NO.	DESCRIPTION
37186-25	EICKEN ANTRUM CANNULA, 14CM, 2.5MM DIA.(SHORT CURVE)
37186-30	EICKEN ANTRUM CANNULA, 14CM, 3.0MM DIA.(SHORT CURVE)
37186-40	EICKEN ANTRUM CANNULA, 14CM, 4.0MM DIA.(SHORT CURVE)

TILLEY-LICHTWITZ TROCARS



ITEM NO.	DESCRIPTION
37128-05	TILLEY-LICHTWITZ ATRUM TROCAR, 1.7MM, 19.5CM LENGTH
37128-06	TILLEY-LICHTWITZ ATRUM TROCAR, 2.0MM, 19.5CM LENGTH
37128-07	TILLEY-LICHTWITZ ATRUM TROCAR, 2.3MM, 19.5CM LENGTH
37128-08	TILLEY-LICHTWITZ ATRUM TROCAR, 2.7MM, 19.5CM LENGTH
37128-09	TILLEY-LICHTWITZ ATRUM TROCAR, 3.0MM, 19.5CM LENGTH



FESS SINUSCOPY INSTRUMENTS



MADE IN THE USA

SINUSCOPY ELEVATORS & KNIVES



ITEM NO.	DESCRIPTION
37180-05	GORNEY (FREER), 3MM SUCTION ELEVATOR W/ OBTURATOR 20CM

ITEM NO.	DESCRIPTION
37415-18	FREER SEPTUM KNIFE, CURVED TO SIDE, 18CM

ITEM NO.	DESCRIPTION
37424-17	WULLSTEIN-STORZ ELEVATOR, SHARP, 17CM



ITEM NO.	DESCRIPTION
37386-01	ANTRUM SICKLE KNIFE, POINTED TIP, 18CM
37386-02	ANTRUM SICKLE KNIFE, BLUNT TIP, 18CM

ITEM NO.	DESCRIPTION
37380-01	SICKLE KNIFE, POINTED, 7½" LENGTH, 19CM
37380-02	SICKLE KNIFE, ROUND BLUNT, DBL CUTTING, 7½" LENGTH, 19CM



FESS SINUSCOPY INSTRUMENTS



MADE IN THE USA

SINUSCOPY CURETTES



ITEM NO.	DESCRIPTION
37378-01	ANTRUM CURETTE, OVAL, 19CM, SIZE 1
37378-02	ANTRUM CURETTE, OVAL, 19CM, SIZE 2
37378-03	ANTRUM CURETTE, OVAL, 19CM, SIZE 3

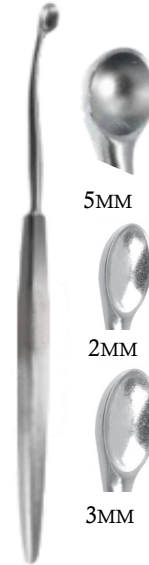

ITEM NO.	DESCRIPTION
37382-11	ANTRUM CURETTE, ROUND CUP, 7½" (19CM) LENGTH
37382-12	ANTRUM CURETTE, ANGLED CUP, OBLONG SMALL, 7½" (19CM) LENGTH
37382-13	ANTRUM CURETTE, ANGLED CUP, OBLONG LARGE, 7½" (19CM) LENGTH



ITEM NO.	DESCRIPTION
37362-01	FRONTAL SINUS CURETTE, OBLONG, 55° CURVED, 19CM
37362-02	FRONTAL SINUS CURETTE, OBLONG, 90° CURVED, 19CM



ITEM NO.	DESCRIPTION
37387-00	ANTRUM CURETTE, FORWARD CUTTING, SMALL, 19CM
37287-01	ANTRUM CURETTE, FORWARD CUTTING, LARGE, 19CM



FESS SINUSCOPY INSTRUMENTS



MADE IN THE USA

SINUSCOPY DISSECTORS & PROBES



ITEM NO.	DESCRIPTION
37432-21	KISTNER PROBE-DISSECTOR, 21CM



ITEM NO.	DESCRIPTION
37594-01	FREER DISSECTOR SHARP/BLUNT, 7" 18CM



ITEM NO.	DESCRIPTION
37421-21	DOUBLE-ENDED PROBE, BALL-END ELEVATOR 18CM



Ø 2.6 MM



Ø 2.2 MM



ITEM NO.	DESCRIPTION
37431-21	FRONTAL OSTIUM SEEKER PROBE, 21CM

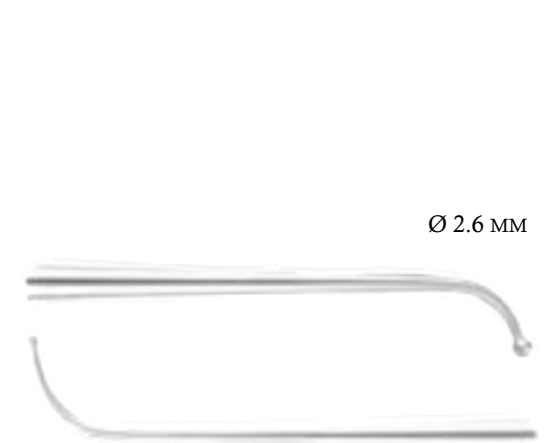

Ø 2.3 MM

Ø 2.6 MM

ITEM NO.	DESCRIPTION
37433-21	MAXILLARY OSTIUM SEEKER PROBE, 21CM



FESS SINUSCOPY INSTRUMENTS



MADE IN THE USA

KILLIAN SEPTUM SPECULA W/ FIBER-OPTIC LIGHT CARRIER



- POWERFUL LIGHT EMISSION
- EASY TO DISMANTLE & CLEAN
- REMOVABLE FIBER-OPTIC ROD

ITEM NO.	DESCRIPTION
37122-40	KILLIAN SEPTUM SPECULA W/ FIBER-OPTIC, SIZE 1 (40MM)
37122-55	KILLIAN SEPTUM SPECULA W/ FIBER-OPTIC, SIZE 2 (55MM)
37122-75	KILLIAN SEPTUM SPECULA W/ FIBER-OPTIC, SIZE 3 (75MM)
37122-90	KILLIAN SEPTUM SPECULA W/ FIBER-OPTIC, SIZE 4 (95MM)
ITEM NO.	DESCRIPTION
37122-98	SPARE FIBER-OPTIC LIGHT CARRIER ONLY

KILLIAM SEPTUM SPECULA



ITEM NO.	DESCRIPTION
37120-35	KILLIAN SEPTUM SPECULA, SIZE 1 (35MM)
37120-50	KILLIAN SEPTUM SPECULA, SIZE 2 (50MM)
37120-64	KILLIAN SEPTUM SPECULA, SIZE 3 (64MM)
37120-75	KILLIAN SEPTUM SPECULA, SIZE 4 (75MM)
37120-90	KILLIAN SEPTUM SPECULA, SIZE 4 (95MM)



ITEM NO.	DESCRIPTION
37122-01	KILLIAN-STRUYCKEN NASAL SPECULA (15CM), LEFT BLADE (75MM), RIGHT BLADE (45MM) *PICTURED
37121-02	KILLIAN-STRUYCKEN NASAL SPECULA (15CM), LEFT BLADE (45MM), RIGHT BLADE (75MM)



FESS SINUSCOPY INSTRUMENTS



MADE IN THE USA

SEPTUM SPECULA & NASAL SPECULA



ITEM NO.	DESCRIPTION
37130-35	COTTLE SEPTUM SPECULA (15CM) W/ EXTRA SLENDER BLADES & TAKE-APART JOINT, SIZE 1 (40MM)
37130-50	COTTLE SEPTUM SPECULA (15CM) W/ EXTRA SLENDER BLADES & TAKE-APART JOINT, SIZE 2 (55MM)
37130-75	COTTLE SEPTUM SPECULA (15CM) W/ EXTRA SLENDER BLADES & TAKE-APART JOINT, SIZE 3 (75MM)
37130-90	COTTLE SEPTUM SPECULA (15CM) W/ EXTRA SLENDER BLADES & TAKE-APART JOINT, SIZE 4 (95MM)



ITEM NO.	DESCRIPTION
37126-35	WALTER (MOD.COTTLE) SEPTUM SPECULA (15CM) W/ EXTREMELY THIN BLADES & LATERAL SET SCREW, SIZE 1 (35MM)
37126-55	WALTER (MOD.COTTLE) SEPTUM SPECULA (15CM) W/ EXTREMELY THIN BLADES & LATERAL SET SCREW, SIZE 2 (55MM)
37126-75	WALTER (MOD.COTTLE) SEPTUM SPECULA (15CM) W/ EXTREMELY THIN BLADES & LATERAL SET SCREW, SIZE 3 (75MM)



ITEM NO.	DESCRIPTION
37116-13	TIECK-HALL NASAL SPECULA FOR
37116-16	TIECK-HALL NASAL SPECULA FOR



ITEM NO.	DESCRIPTION
37102-01	HARTMANN-HALLE NASAL SPECULA (15CM) (SMALL)
37102-02	HARTMANN-HALLE NASAL SPECULA (15CM) (MEDIUM)
37102-03	HARTMANN-HALLE NASAL SPECULA (15CM) (LARGE)



FESS SINUSCOPY INSTRUMENTS



MADE IN THE USA

SEPTUM SPECULA & NASAL SPECULA

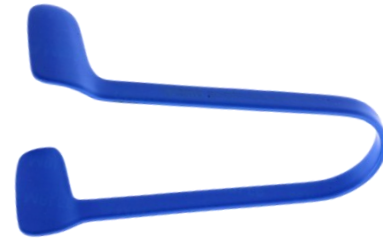

ITEM NO.	DESCRIPTION
37050-01	THUDICUM NASAL SPECULA(7CM), SIZE 1
37050-02	THUDICUM NASAL SPECULA(7CM), SIZE 2
37050-03	THUDICUM NASAL SPECULA(7CM), SIZE 3
37050-04	THUDICUM NASAL SPECULA(7CM), SIZE 4
37050-05	THUDICUM NASAL SPECULA(7CM), SIZE 5
37050-06	THUDICUM NASAL SPECULA(7CM), SIZE 6
37050-07	THUDICUM NASAL SPECULA(7CM), SIZE 7

ITEM NO.	DESCRIPTION
37050-01-I	THUDICUM NASAL SPECULA, INSULATED, (7CM), SIZE 1
37050-02-I	THUDICUM NASAL SPECULA, INSULATED, (7CM), SIZE 2
37050-03-I	THUDICUM NASAL SPECULA, INSULATED, (7CM), SIZE 3
37050-04-I	THUDICUM NASAL SPECULA, INSULATED, (7CM), SIZE 4
37050-05-I	THUDICUM NASAL SPECULA, INSULATED, (7CM), SIZE 5
37050-06-I	THUDICUM NASAL SPECULA, INSULATED, (7CM), SIZE 6
37050-07-I	THUDICUM NASAL SPECULA, INSULATED, (7CM), SIZE 7



ITEM NO.	DESCRIPTION
37154-01	ST. CLAIR THOMPSON NASAL SPECULA (7.5CM), SIZE 1 (38MM)
37154-02	ST. CLAIR THOMPSON NASAL SPECULA (7.5CM), SIZE 2 (51MM)
37154-03	ST. CLAIR THOMPSON NASAL SPECULA (7.5CM), SIZE 3 (54MM)
37154-04	ST. CLAIR THOMPSON NASAL SPECULA (7.5CM), SIZE 4 (76MM)



ITEM NO.	DESCRIPTION
39120-13	BECKMANN ENDAURAL SPECULUM FOR INFANTS, CURVED TO THE SIDE (13CM)
39120-15	BECKMANN ENDAURAL SPECULUM, CURVED TO THE SIDE (15CM)

ITEM NO.	DESCRIPTION
37112-01	VIENNA NASAL SPECULA (14CM) (SIZE 1, SMALL)
37112-02	VIENNA NASAL SPECULA (14CM) (SIZE 2, MEDIUM)
37112-03	VIENNA NASAL SPECULA (14CM) (SIZE 3, LARGE)



FESS SINUSCOPY INSTRUMENTS



MADE IN THE USA

ANTRUM & SPHENOIDAL PUNCHES

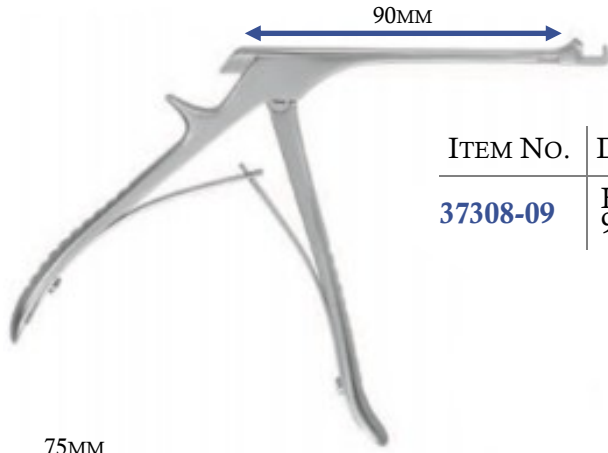

ITEM NO.	DESCRIPTION
37308-09	BEYER ANTRUM PUNCH, VERY DELICATE, 9CM SHAFT LENGTH, 2MM BITE



ITEM NO.	DESCRIPTION
37311-12	CITELLI ANTRUM PUNCH, 7.5CM SHAFT LENGTH, SIZE 1 (1.5MM)
37311-25	CITELLI ANTRUM PUNCH, 7.5CM SHAFT LENGTH, SIZE 2 (2.0MM)
37311-30	CITELLI ANTRUM PUNCH, 7.5CM SHAFT LENGTH, SIZE 3 (3.0MM)



ITEM NO.	DESCRIPTION
37303-00	KERRISON ANTRUM PUNCH, 9CM SHAFT LENGTH, SIZE 0 (3MM)
37303-01	KERRISON ANTRUM PUNCH, 9CM SHAFT LENGTH, SIZE 1 (4MM)
37303-02	KERRISON ANTRUM PUNCH, 9CM SHAFT LENGTH, SIZE 2 (5MM)
37389-03	KERRISON ANTRUM PUNCH, 9CM SHAFT LENGTH, SIZE 3 (6MM)



FESS SINUSCOPY INSTRUMENTS



MADE IN THE USA

ANTRUM & SPHENOIDAL PUNCHES

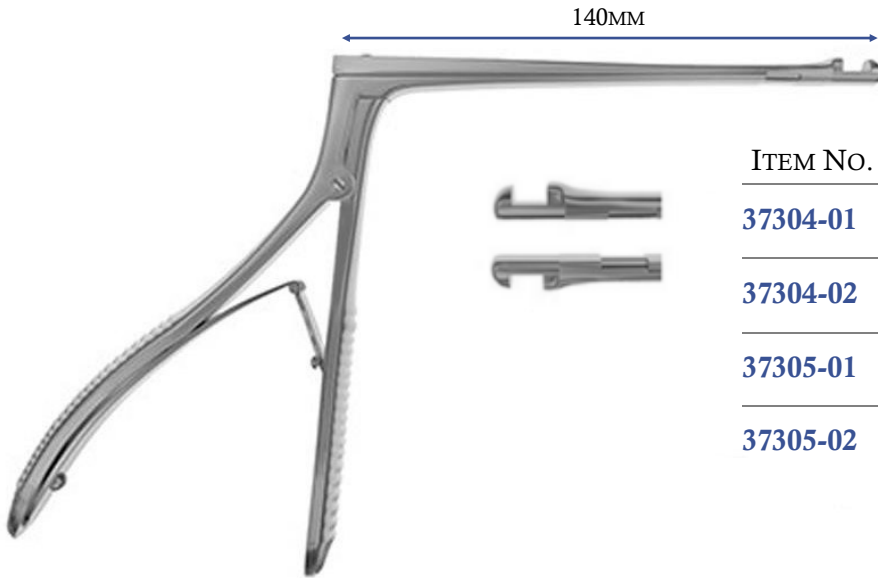

ITEM NO.	DESCRIPTION
37304-01	HAJEK SPHENOIDAL PUNCH (14CM SHAFT LENGTH), UP-CUTTING (3.2MM)
37304-02	HAJEK SPHENOIDAL PUNCH (14CM SHAFT LENGTH), UP-CUTTING (4MM)
37305-01	HAJEK SPHENOIDAL PUNCH (14CM SHAFT LENGTH), DOWN-CUTTING (3.2MM)
37305-02	HAJEK SPHENOIDAL PUNCH (14CM SHAFT LENGTH), DOWN-CUTTING (4MM)

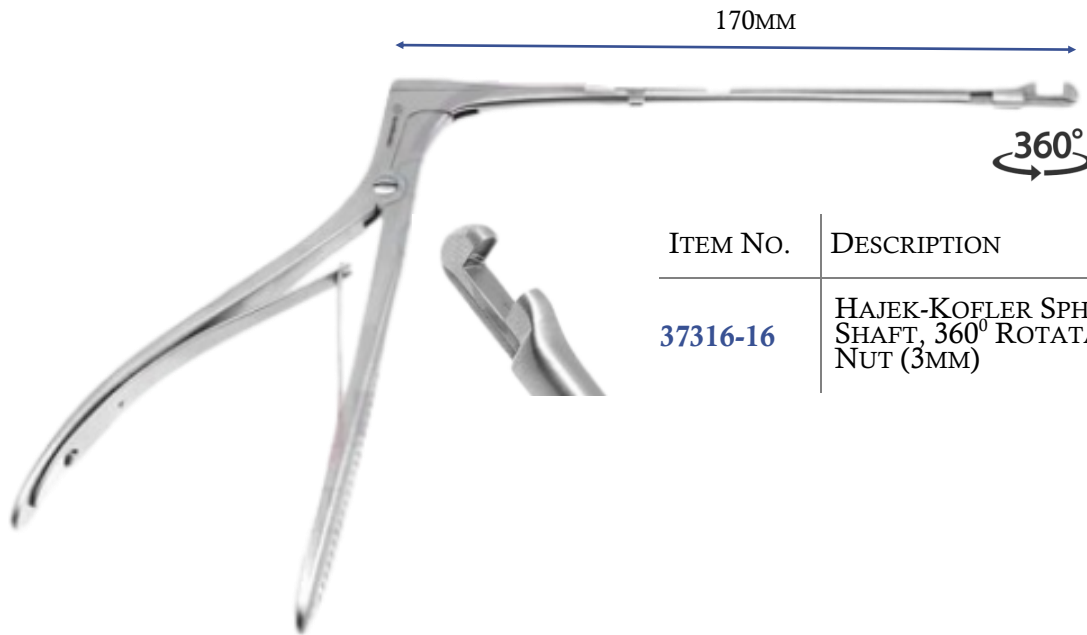

ITEM NO.	DESCRIPTION
37316-16	HAJEK-KOFLER SPHENOIDAL PUNCH, 18MM SHAFT, 360° ROTATABLE, W/ FIXATION NUT (3MM)



FESS SINUSCOPY INSTRUMENTS



MADE IN THE USA

ANTRUM & SPHENOIDAL PUNCHES

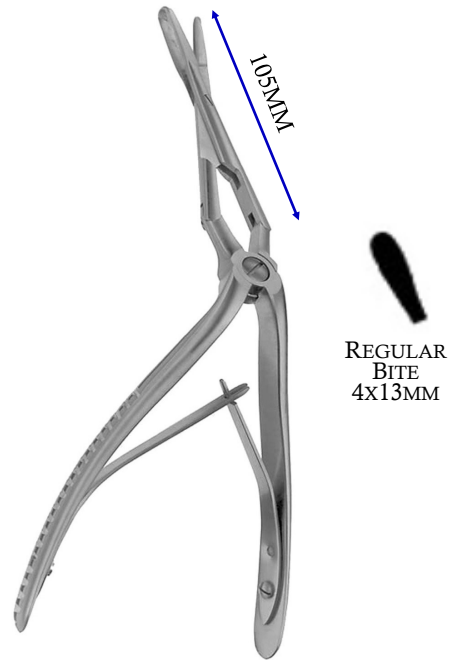
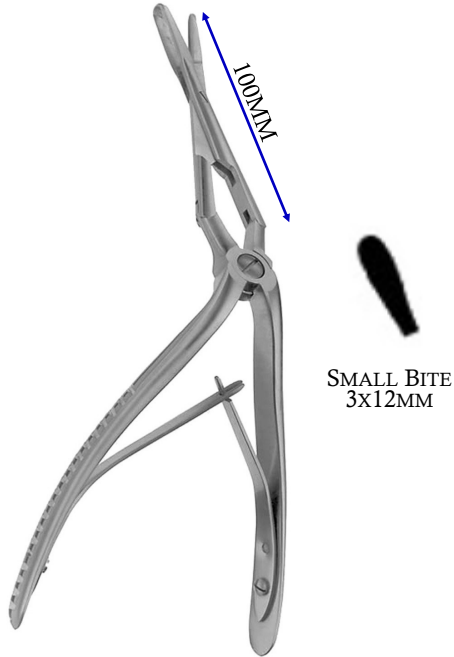

ITEM NO.	DESCRIPTION
37318-19	JANSEN-STRUYCKEN SEPTUM PUNCH FORCEPS THROUGH CUTTING (10CM)

ITEM NO.	DESCRIPTION
37323-19	JANSEN-STRUYCKEN SEPTUM PUNCH FORCEPS THROUGH CUTTING (10.5CM)

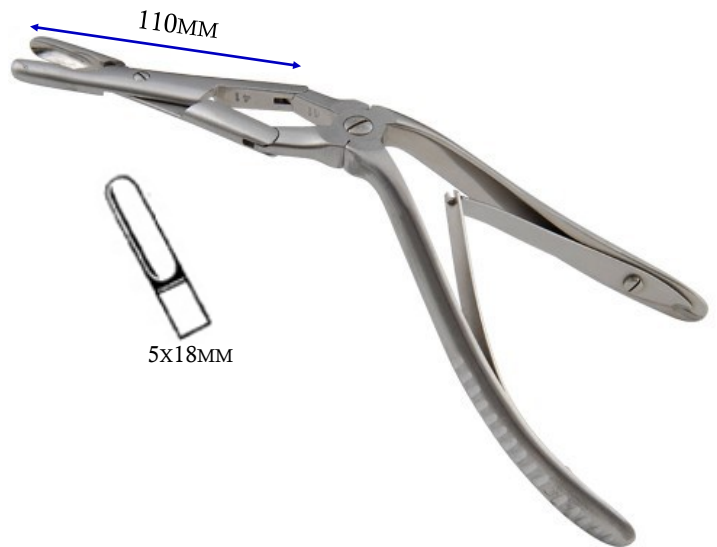
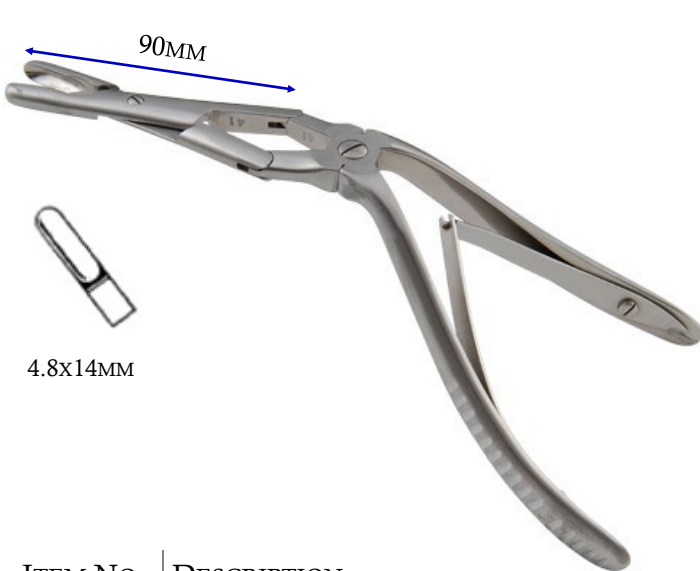

ITEM NO.	DESCRIPTION
37321-19	JANSEN-MIDDLETON SEPTUM FORCEPS COMPOUND ACTION (9CM)

ITEM NO.	DESCRIPTION
37325-19	JANSEN-MIDDLETON SEPTUM FORCEPS COMPOUND ACTION (11CM)



FIBEROPTIC LARYNGOSCOPES



MADE IN THE USA

LARYNGOSCOPES

TUCKER MID-LIGHTED SIDE SLIDE LARYNGOSCOPE

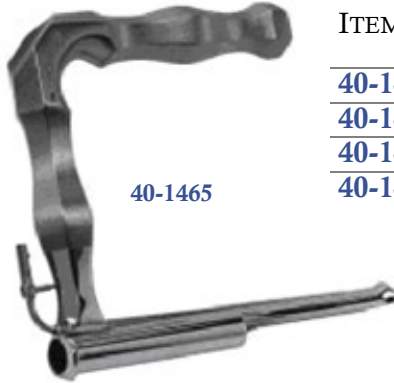

ITEM NO.	SIZE	OVERALL LENGTH	MIN I.D.	NOMINAL PROXIMAL I.D.	MAX O.D.	LIGHT CARRIER #
40-1450	CHILD	90MM	6.9MM	9.0 MM	14.0 MM	40-6510
40-1455	ADOLESCENT	114MM	9.1MM	10.0 MM	17.0 MM	40-6512
40-1460	ADULT	120MM	10.7MM	12.0 MM	19.0 MM	40-6515
40-1465	LONG ADULT	160MM	11.8MM	12.0 MM	19.0 MM	40-6516

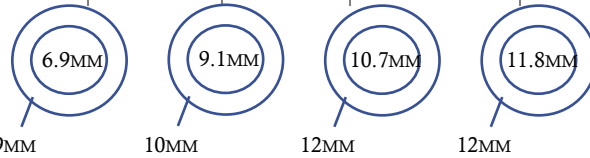

ILLUSTRATIONS ARE FOR MEASUREMENT PURPOSES ONLY
 NOT TO SCALE



HOLLINGER INFANT (NEWBORN) SLIDE LARYNGOSCOPE

ITEM NO.	SIZE	OVERALL LENGTH	MIN I.D.	NOMINAL PROXIMAL I.D.	MAX O.D.	LIGHT CARRIER #
40-1500	INFANT	81MM	8MM	9.0MM	14.0MM	40-6204

JACKSON STANDARD FIBER OPTIC SLIDE LARYNGOSCOPE



ITEM NO.	SIZE	OVERALL LENGTH	MIN I.D.	NOMINAL PROXIMAL I.D.	MAX O.D.	LIGHT CARRIER #
40-1550	INFANT	95MM	8.0MM	10.0MM	16.0MM	40-600
40-1552	CHILD	125MM	10.5MM	12.0MM	17.0MM	40-6006
40-1554	ADOLESCENT	159MM	10.6MM	12.0MM	17.0MM	40-6018
40-1556	ADOLESCENT / ADULT	159MM	11.4MM	13.0MM	18.0MM	40-6018
40-158	ADULT	159MM	13.0MM	14.0MM	21.0MM	40-6018

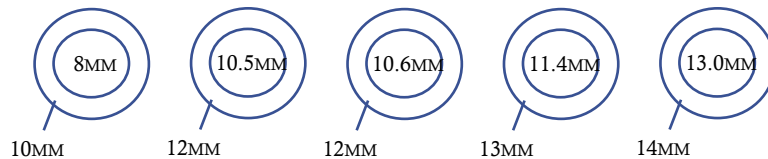

ILLUSTRATIONS ARE FOR MEASUREMENT PURPOSES ONLY
 NOT TO SCALE



FIBER OPTIC LARYNGOSCOPES



MADE IN THE USA

LARYNGOSCOPES

HOLINGER "HOURLASS" ANTERIOR COMMISSURE LARYNGOSCOPE



ITEM No.	SIZE	OVERALL LENGTH	MIN I.D.	NOMINAL PROXIMAL I.D.	MAX O.D.	LIGHT CARRIER #
40-2030	ADULT	171MM	7.7MM	12 X 20MM	20.2MM	40-6213
40-2032	ADULT X-LARGE	181MM	7.3MM	12 X 20MM	20.4MM	40-6214

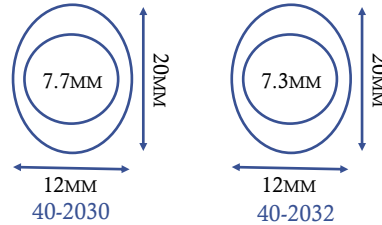

HOLINGER "SLOTTED" ANTERIOR COMMISSURE LARYNGOSCOPE

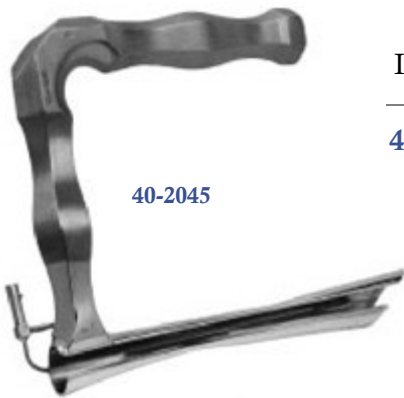

ITEM No.	SIZE	OVERALL LENGTH	MIN I.D.	NOMINAL PROXIMAL I.D.	MAX O.D.	LIGHT CARRIER #
40-2045	ADULT "SLOTTED"	170MM	8.2MM	11 X 19MM	20.2MM	40-6212

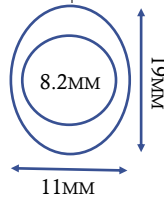

ILLUSTRATIONS ARE FOR MEASUREMENT PURPOSES ONLY
NOT TO SCALE

TRACHEA SCOPES

TUCKER TRACHESCOPE



ITEM No.	SIZE	OVERALL LENGTH	MIN I.D.	NOMINAL PROXIMAL I.D.	MAX O.D.	LIGHT CARRIER #
40-2403	5 X 18MM	180MM	5.0MM	11.0MM	13.0MM	40-7521

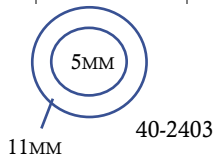

ILLUSTRATIONS ARE FOR MEASUREMENT PURPOSES ONLY
NOT TO SCALE

FEARON TRACHESCOPE



ITEM No.	SIZE	OVERALL LENGTH	MIN I.D.	NOMINAL PROXIMAL I.D.	MAX O.D.	LIGHT CARRIER #
40-2404	3 X 20MM	203MM	2.5MM	11.9MM	11.0MM	40-7521

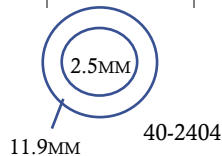

ILLUSTRATIONS ARE FOR MEASUREMENT PURPOSES ONLY
NOT TO SCALE



FIBER OPTIC LARYNGOSCOPES



MADE IN THE USA

LARYNGOSCOPES

JACKSON DIRECT OR ANTERIOR COMMISSURE LARYNGOSCOPE



40-1820

ITEM NO.	SIZE	OVERALL LENGTH	MIN I.D.	NOMINAL PROXIMAL I.D.	MAX O.D.	LIGHT CARRIER #
40-1820	CHILD	133MM	5.8MM	7.7 X 9.8MM	13.6MM	40-6008
40-1824	ADULT	155MM	6.8MM	10 X 11MM	16.0MM	40-6026

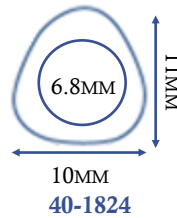
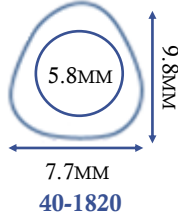

ILLUSTRATIONS ARE FOR MEASUREMENT PURPOSES ONLY
NOT TO SCALE

TUCKER-HOLLIGER ANTERIOR COMMISSURE LARYNGOSCOPES



40-2000

ITEM NO.	SIZE	OVERALL LENGTH	MIN I.D.	NOMINAL PROXIMAL I.D.	MAX O.D.	LIGHT CARRIER #
40-2000	INFANT	96MM	5.4MM	9.0MM	13.6MM	40-6203
40-2001	CHILD	119MM	5.6MM	13.0MM	16.0MM	40-6201

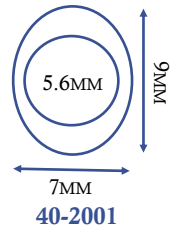
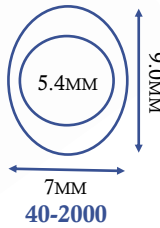

ILLUSTRATIONS ARE FOR MEASUREMENT PURPOSES ONLY
NOT TO SCALE



HOLLINGER ANTERIOR COMMISSURE LARYNGOSCOPES



40-2040

ITEM NO.	SIZE	OVERALL LENGTH	MIN I.D.	NOMINAL PROXIMAL I.D.	MAX O.D.	LIGHT CARRIER #
40-2002	INFANT	97MM	3.7MM	6 X 9MM	9.8MM	40-6206
40-2004	CHILD	120MM	7.0MM	8 X 12MM	13.0MM	40-6210
40-2010	ADULT	170MM	8.3MM	10 X 14MM	19.0MM	40-6028
40-2012	ADULT X-LARGE	180MM	8.3MM	10 X 14MM	19.0MM	40-6038
40-2040	ADULT SLOTTED	170MM	8.5MM	10 X 14MM	19.0MM	40-6028

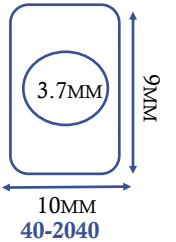
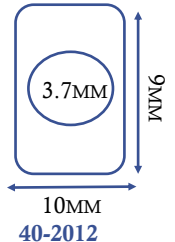
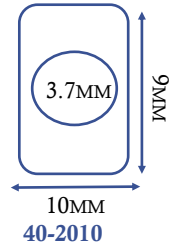
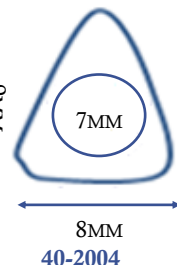
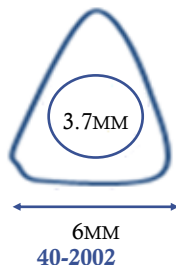

ILLUSTRATIONS ARE FOR MEASUREMENT PURPOSES ONLY
NOT TO SCALE



FIBER OPTIC LARYNGOSCOPES



MADE IN THE USA

MICRO-LARYNGOSCOPES

JAKO TYPE I

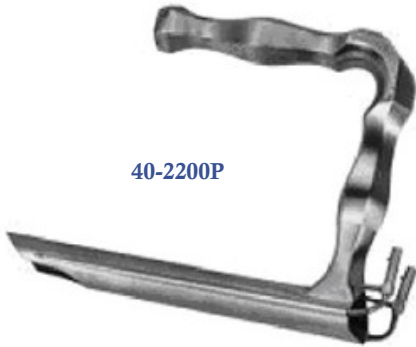

40-2200P

ITEM NO.	SIZE	OVERALL LENGTH	MIN I.D.	NOMINAL PROXIMAL I.D.	MAX O.D.	LIGHT CARRIER #
40-2200P	ADULT	178MM	13MM	21 X 19MM	34.0MM	40-6365R 40-6366L

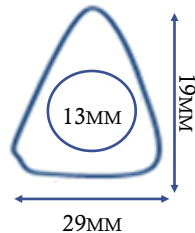

40-2200P

CHERRY-JAKO TYPE I



40-2207

ITEM NO.	SIZE	OVERALL LENGTH	MIN I.D.	NOMINAL PROXIMAL I.D.	MAX O.D.	LIGHT CARRIER #
40-2207	ADOLESC.	149MM	11MM	25 X 14MM	31.0MM	40-6375R 40-6376L
40-2210	CHILD	121MM	9.4MM	20 X 12MM	26.0MM	40-6370R 40-6371L

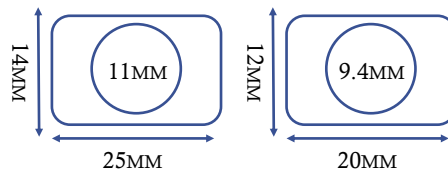

ILLUSTRATIONS ARE FOR MEASUREMENT PURPOSES ONLY
NOT TO SCALE

JAKO MICRO-LARYNGOSCOPE TYPE II



40-2205

ITEM NO.	SIZE	OVERALL LENGTH	MIN I.D.	NOMINAL PROXIMAL I.D.	MAX O.D.	LIGHT CARRIER #
40-2205	ADULT	178MM	11.1MM	29 X 19MM	38.0MM	40-7805R 40-7800L

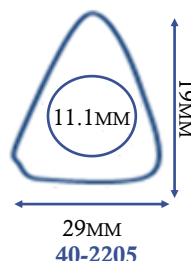

ILLUSTRATIONS ARE FOR MEASUREMENT PURPOSES ONLY
NOT TO SCALE



FIBER OPTIC LARYNGOSCOPES



MADE IN THE USA

MICRO-LARYNGOSCOPES

CHERRY-JAKO MICRO-LARYNGOSCOPE TYPE II



40-2208

ITEM NO.	SIZE	OVERALL LENGTH	MIN I.D.	NOMINAL PROXIMAL I.D.	MAX O.D.	LIGHT CARRIER #
40-2208	ADOLESC.	149MM	8.8MM	24 X 14MM	34.0MM	40-78215 40-7810L
40-2215	CHILD	120MM	9.3MM	20 X 12MM	28.0MM	40-7825R 40-7820L
40-2220	NEWBORN	114MM	7.8MM	18 X 10MM	25.0MM	40-7825R 40-7820L

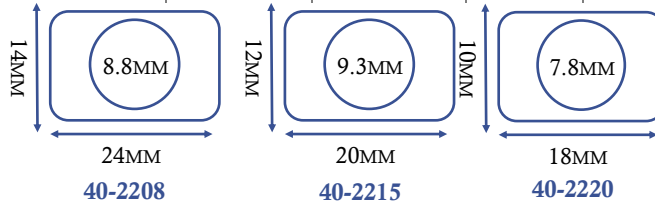

ILLUSTRATIONS ARE FOR MEASUREMENT PURPOSES ONLY
NOT TO SCALE



40-2220

JAKO MICRO-LARYNGOSCOPE TYPE III



40-2206

ITEM NO.	SIZE	OVERALL LENGTH	MIN I.D.	NOMINAL PROXIMAL I.D.	MAX O.D.	LIGHT CARRIER #
40-2206	ADOLESC.	178MM	13.4MM	29 X 20MM	34.0MM	40-6526
40-2209	CHILD	149MM	11.7MM	25 X 13MM	30.0MM	40-6527
40-2216	NEWBORN	120MM	9.1MM	20 X 13MM	25.0MM	40-6528

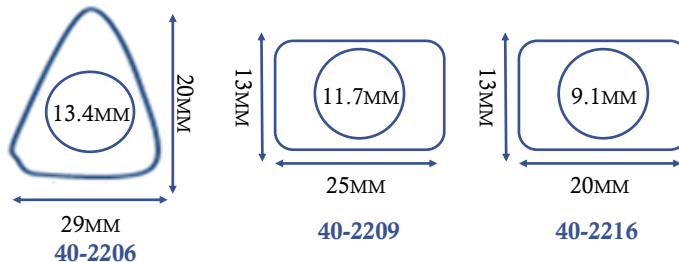

ILLUSTRATIONS ARE FOR MEASUREMENT PURPOSES ONLY
NOT TO SCALE



40-2209



FIBER OPTIC LARYNGOSCOPES



MADE IN THE USA

MICRO-LARYNGOSCOPES

OSSOFF-PILLING MICRO-LARYNGOSCOPE



ITEM NO.	SIZE	OVERALL LENGTH	MIN I.D.	NOMINAL PROXIMAL I.D.	MAX O.D.	LIGHT CARRIER #
40-2190	ADULT	168.2MM	7.0MM	19 X 15MM	22.0MM	40-7864
40-2191	ADULT	168.2MM	8.0MM	24 X 14MM	27.0MM	40-7865

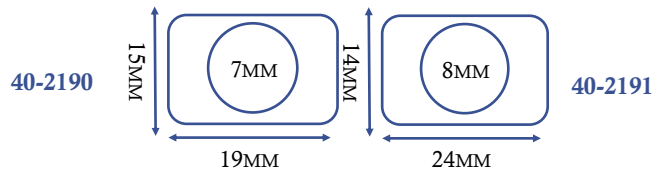

ILLUSTRATIONS ARE FOR MEASUREMENT PURPOSES ONLY
 NOT TO SCALE

DEDO-PILLING MICRO-LARYNGOSCOPE



ITEM NO.	SIZE	OVERALL LENGTH	MIN I.D.	NOMINAL PROXIMAL I.D.	MAX O.D.	LIGHT CARRIER #
40-2222	CHILD	119MM	7.1MM	15 X 16MM	22.0MM	40-6524
40-2224	ADOLESC.	145MM	9.1MM	18 X 17MM	25.0MM	40-6529
40-2225P	ADULT	173MM	10.7MM	19 X 19MM	27.0MM	40-6525

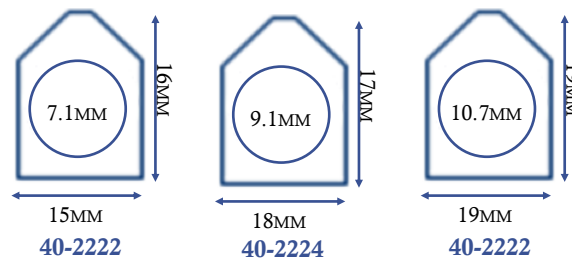

ILLUSTRATIONS ARE FOR MEASUREMENT PURPOSES ONLY
 NOT TO SCALE



LARYNGOSCOPE HOLDERS



MADE IN THE USA



ITEM No.	DESCRIPTION
42-5300	SCOPE HOLDER W/ POSITIVE SCOPE ARTICULATION & ROUND CHEST PLATE DIRECT MOUNTING FOR SCOPES W/ KLEINSASSER SCOPE HANDLE
42-5301	UNIVERSAL SCOPE HOLDER W/ POSITIVE SCOPE ARTICULATION & CHEST BAR. DIRECT MOUNTING FOR SCOPES W/ PILLING TYPE HANDLE

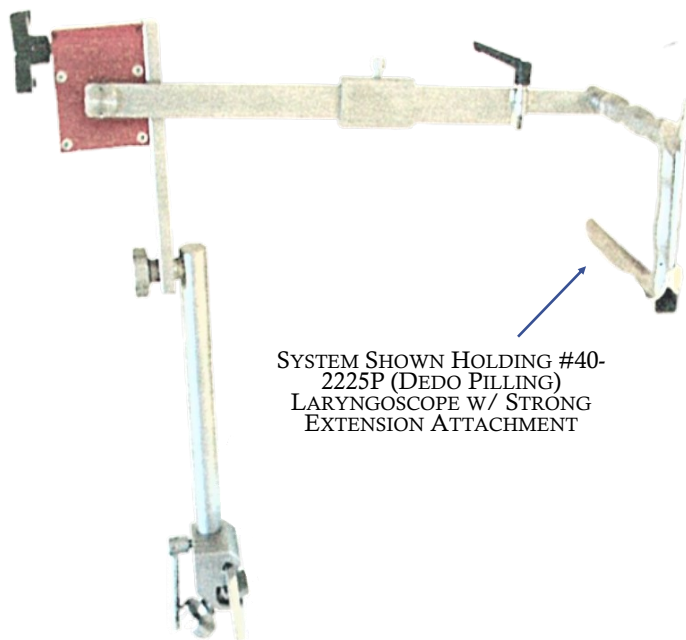

SYSTEM SHOWN HOLDING #40-2225P (DEDO PILLING) LARYNGOSCOPE W/ STRONG EXTENSION ATTACHMENT

ITEM No.	DESCRIPTION
40-088-00	ELMED ARTICULATING LARYNGOSCOPE SUSPENSION SYSTEM (INCLUDES ARM & TABLE CLAMP)

FEATURING:

- SUPPORTS THE LARYNGOSCOPE FOR TWO HANDED SURGERY
- NOT AFFECTED BY CHEST MOVEMENT
- ALLOWS USE OF THE BOYCE-JACKSON POSITION
- ALLOWS REPOSITIONING AT THE TABLE AS NECESSARY W/OUT READJUSTMENT OF THE SUSPENSION SYSTEM



LARYNGEAL INSTRUMENTS



MADE IN THE USA

MICRO SCISSORS & FORCEPS

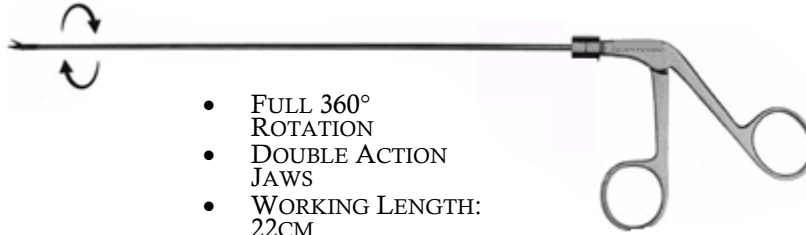

- FULL 360° ROTATION
- DOUBLE ACTION JAWS
- WORKING LENGTH: 22CM

SCISSORS



ITEM NO.	SIZE	WORKING LENGTH	DESCRIPTION
42-2203	2MM	22CM	CUTTING FORCEPS, W/ ROUND CUPPED DOUBLE ACTION JAWS, CURVED
42-2206	2MM	22CM	ALLIGATOR FORCEPS W/ SERRATED, DOUBLE ACTION JAWS, CURVED
42-2207	2MM	22CM	GRASPING FORCEPS W/ TRIANGULAR, SERRATED, DOUBLE ACTION JAWS, CURVED UPWARDS
42-2210	2MM	22CM	SCISSORS, CURVED

ANTERIOR COMMISSURE FORCEPS & SCISSORS

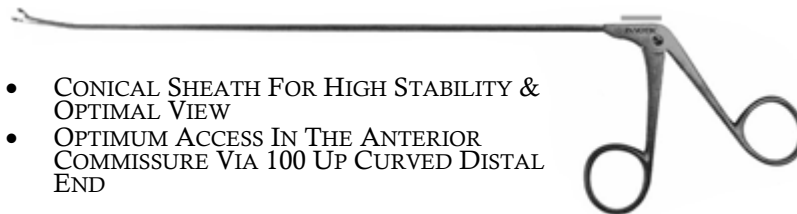

- CONICAL SHEATH FOR HIGH STABILITY & OPTIMAL VIEW
- OPTIMUM ACCESS IN THE ANTERIOR COMMISSURE VIA 100 UP CURVED DISTAL END

CUTTING FORCEPS



ITEM NO.	SIZE	WORKING LENGTH	DESCRIPTION
42-2101	2MM	22CM	CUTTING FORCEPS, W/ ROUND, CUPPED JAWS, STRAIGHT
42-2102	2MM	22CM	CUTTING FORCEPS, W/ ROUND, CUPPED JAWS, CURVED UPWARD
42-2103	2MM	22CM	CUTTING FORCEPS, W/ ROUND, CUPPED JAWS, CURVED RIGHT
42-2104	2MM	22CM	CUTTING FORCEPS, W/ ROUND, CUPPED JAWS, CURVED LEFT
42-2108	2MM	22CM	SCISSORS, STRAIGHT
42-2109	2MM	22CM	SCISSORS, UP CURVED 45°
42-2110	2MM	22CM	SCISSORS, CURVED RIGHT
42-2111	2MM	22CM	SCISSORS, CURVED LEFT



LARYNGEAL INSTRUMENTS



MADE IN THE USA

CUTTING FORCEPS

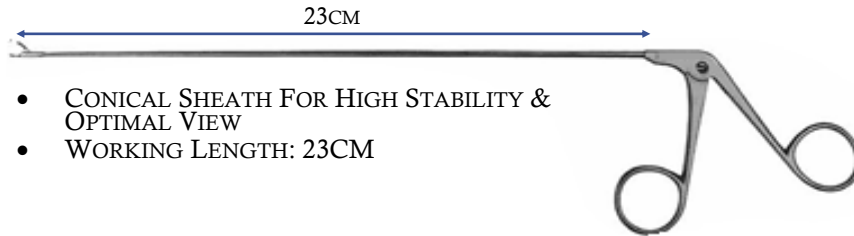

- CONICAL SHEATH FOR HIGH STABILITY & OPTIMAL VIEW
- WORKING LENGTH: 23CM

	ITEM No.	SIZE	WORKING LENGTH	DESCRIPTION
STANDARD	42-2001	2MM	23CM	CUTTING FORCEPS W/ ROUND CUPPED JAWS, STRAIGHT
	42-2002	2MM	23CM	CUTTING FORCEPS W/ ROUND CUPPED JAWS, CURVED UPWARDS
	42-2003	2MM	23CM	CUTTING FORCEPS W/ ROUND CUPPED JAWS, CURVED LEFT
	42-2004	2MM	23CM	CUTTING FORCEPS W/ ROUND CUPPED JAWS CURVED RIGHT
	42-2050	2MM	23CM	CUTTING FORCEPS W/ ROUND CUPPED JAWS, CURVED UPWARDS LEFT
	42-2051	2MM	23CM	CUTTING FORCEPS W/ ROUND CUPPED JAWS, CURVED UPWARDS RIGHT
	42-2052	2MM	23CM	CUTTING FORCEPS W/ ROUND CUPPED JAWS, HORIZONTAL OPENING, CURVED LEFT
	42-2040	3X5MM	23CM	FORCEPS W/ OVAL CUPPED JAWS, STRAIGHT
	42-2041	4MM	23CM	FORCEPS W/ ROUND CUPPED JAWS, STRAIGHT
	42-2042	4MM	23CM	FORCEPS W/ ROUND CUPPED JAWS, CURVED UPWARDS
HEAVY	42-2043	4MM	23CM	FORCEPS W/ ROUND CUPPED JAWS, CURVED RIGHT
	42-2044	4MM	23CM	FORCEPS W/ ROUND CUPPED JAWS, CURVED LEFT
	42-2046	5MM	23CM	CUTTING FORCEPS W/ ROUND CUPPED, DOUBLE ACTION JAWS, STRAIGHT
	42-2001	2MM	23CM	MINIATURE CUTTING FORCEPS W/ CUPPED JAWS, STRAIGHT
DOUBLE ACTION	42-2002	2MM	23CM	MINIATURE CUTTING FORCEPS W/ CUPPED JAWS, CURVED UPWARD
	42-2003	2MM	23CM	MINIATURE CUTTING FORCEPS W/ CUPPED JAWS, CURVED RIGHT
	42-2004	2MM	23CM	MINIATURE CUTTING FORCEPS W/ CUPPED JAWS, CURVED LEFT
MINIATURE	42-2050	2MM	23CM	MINIATURE CUTTING FORCEPS W/ CUPPED JAWS, CURVED UPWARDS RIGHT
	42-2051	2MM	23CM	MINIATURE CUTTING FORCEPS W/ CUPPED JAWS, CURVED UPWARDS LEFT



LARYNGEAL INSTRUMENTS



MADE IN THE USA

GRASPING FORCEPS

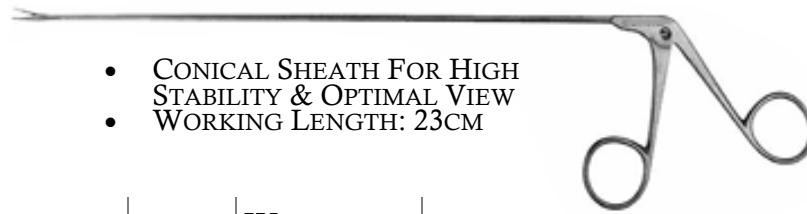

- CONICAL SHEATH FOR HIGH STABILITY & OPTIMAL VIEW
- WORKING LENGTH: 23CM

ITEM NO.	SIZE	WORKING LENGTH	DESCRIPTION
42-2105	2MM	23CM	ALLIGATOR FORCEPS, SERRATED, STRAIGHT W/ RATCHET
42-2005	2MM	23CM	ALLIGATOR FORCEPS, SERRATED, STRAIGHT
42-2006	2MM	23CM	ALLIGATOR FORCEPS, SERRATED, CURVED RIGHT
42-2007	2MM	23CM	ALLIGATOR FORCEPS, SERRATED, CURVED LEFT
42-2215	2MM	23CM	ALLIGATOR FORCEPS, HORIZONTAL OPENING,
42-2054	2MM	23CM	ALLIGATOR FORCEPS, SERRATED, CURVED UP
42-2154	2MM	23CM	ALLIGATOR FORCEPS, HORIZONTAL OPENING, SERRATED, CURVED UP
42-2055	2MM	23CM	FORCEPS W/ TRIANGULAR JAWS, OPENING RIGHT, CURVED UP
42-2056	2MM	23CM	FORCEPS W/ TRIANGULAR JAWS, OPENING UP, CURVED LEFT
42-2058	2MM	23CM	FORCEPS W/ TRIANGULAR JAWS, STRAIGHT
42-2059	2MM	23CM	FORCEPS W/ TRIANGULAR JAWS, CURVED UP
42-2068	2MM	23CM	VOCAL CORD HOLDING FORCEPS W/ TRIANGULAR JAWS, FOR RIGHT SIDE
42-2069	2MM	23CM	VOCAL CORD HOLDING FORCEPS W/ TRIANGULAR JAWS, FOR LEFT SIDE

STANDARD



ITEM NO.	SIZE	WORKING LENGTH	DESCRIPTION
42-2070	2MM	23CM	MINIATURE GRASPING FORCEPS, SERRATED, STRAIGHT
42-2071	2MM	23CM	MINIATURE GRASPING FORCEPS, SERRATED, CURVED UPWARDS
42-2072	2MM	23CM	MINIATURE GRASPING FORCEPS, SERRATED, CURVED RIGHT
42-2073	2MM	23CM	MINIATURE GRASPING FORCEPS, SERRATED, LEFT
42-2076	2MM	23CM	MINIATURE GRASPING FORCEPS W/ TRIANGULAR JAWS, SERRATED, CURVED RIGHT
42-2077	2MM	23CM	MINIATURE GRASPING FORCEPS W/ TRIANGULAR JAWS, SERRATED, CURVED LEFT

MINIATURE





LARYNGEAL INSTRUMENTS



MADE IN THE USA

SCISSORS



- CONICAL SHEATH FOR HIGH STABILITY & OPTIMAL VIEW
- WORKING LENGTH: 23CM

STANDARD



ITEM NO.	SIZE	WORKING LENGTH	DESCRIPTION
42-2008	2MM	23CM	SCISSORS, STRAIGHT
42-2009	2MM	23CM	SCISSORS, CURVED UP 45 ⁰
42-2115	2MM	23CM	SCISSORS, CURVED UP 15 ⁰
42-2010	2MM	23CM	SCISSORS, CURVED RIGHT
42-2011	2MM	23CM	SCISSORS, CURVED LEFT
42-2057	2MM	23CM	SCISSORS, HORIZONTAL CUTTING, STRAIGHT

MINIATURE

ITEM NO.	SIZE	WORKING LENGTH	DESCRIPTION
42-2080	1MM	23CM	MINIATURE SCISSORS, STRAIGHT
42-2081	1MM	23CM	MINIATURE SCISSORS, CURVED UP 45 ⁰
42-2082	1MM	23CM	MINIATURE SCISSORS, CURVED RIGHT
42-2083	1MM	23CM	MINIATURE SCISSORS, CURVED LEFT



LARYNGEAL INSTRUMENTS



MADE IN THE USA

PEDIATRIC FORCEPS & SCISSORS

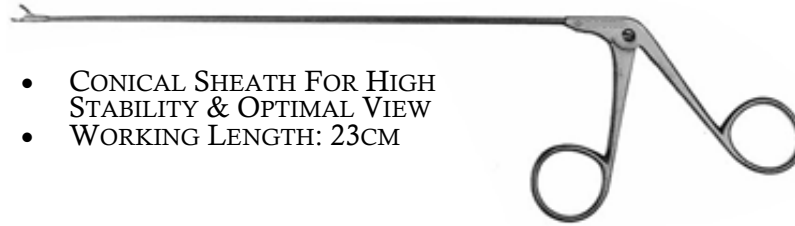

- CONICAL SHEATH FOR HIGH STABILITY & OPTIMAL VIEW
- WORKING LENGTH: 23CM

CUTTING FORCEPS

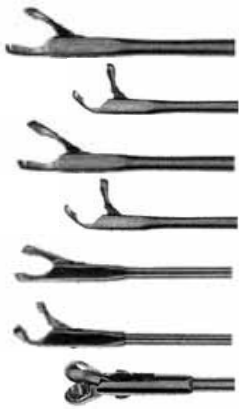

ITEM NO.	SIZE	WORKING LENGTH	DESCRIPTION
42-1902	2MM	18CM	CUTTING FORCEPS W/ CUPPED JAWS, STRAIGHT
42-1903	2MM	18CM	CUTTING FORCEPS W/ CUPPED JAWS, CURVED UP
42-1901	3MM	18CM	CUTTING FORCEPS W/ CUPPED JAWS, STRAIGHT
42-1905	3MM	18CM	CUTTING FORCEPS W/ CUPPED JAWS, CURVED UP
42-1906	1MM	18CM	CUTTING FORCEPS W/ CUPPED JAWS, STRAIGHT
42-1907	1MM	18CM	CUTTING FORCEPS W/ CUPPED JAWS, CURVED UP
42-1930	4MM	18CM	CUTTING FORCEPS W/ CUPPED JAWS W/ HORIZONTAL OPENING & MALLEABLE DISTAL END

GRASPING FORCEPS



ITEM NO.	SIZE	WORKING LENGTH	DESCRIPTION
42-1910	2MM	18CM	ALLIGATOR FORCEPS W/ SERRATED, STRAIGHT

SCISSORS



ITEM NO.	SIZE	WORKING LENGTH	DESCRIPTION
42-1920	2MM	18CM	SCISSORS, STRAIGHT
42-1921	2MM	18CM	SCISSORS, UP CURVED 45 ⁰
42-1922	3MM	18CM	SCISSORS, CURVED RIGHT
42-1923	3MM	18CM	SCISSORS, CURVED LEFT



EUROTEC ENT TREATMENT CHAIRS



MADE IN THE USA

THE EUROTEC ENT I



ITEM NO.	DESCRIPTION
8020	<ul style="list-style-type: none"> • VERY ELEGANT & PROFESSIONAL STYLING • QUALITY CONSTRUCTION & DURABILITY—EASY MAINTENANCE • MAXIMUM PATIENT COMFORT • 360° ROTATION W/ LARGE BASE • FULL HORIZONTAL BED POSITION

THE EUROTEC ENT II



ITEM NO.	DESCRIPTION
8030	<ul style="list-style-type: none"> • SAME FEATURES AS ENT I, BUT FULLY MECHANICAL POWER ASSISTED • NO AC POWER REQUIRED, COMPLETE HYDRAULIC • ECONOMICALLY PRICED





SERVICE AND REPAIR



MADE IN THE USA

IN NEED OF INSTRUMENT REPAIRS? SEND THEM TO THE *ER!*

ELMED REPAIR

60 YEARS OF EXPERIENCE AND KNOWLEDGE IN DESIGNING, ENGINEERING, MANUFACTURING AND REPAIRING FOR THE MEDICAL COMMUNITY HAS GIVEN ELMED, INC. ONE OF THE BEST REPUTATIONS IN THE INDUSTRY. WE REPAIR WHAT OTHERS ARE UNABLE OR UNWILLING TO DO AND WE REPAIR ALL COMPETITIVE BRANDS. OUR WORK IS PERFORMED BY SKILLED TECHNICIANS, ALL OF WHICH HAVE BEEN WITH ELMED FOR THE PAST 10-30 YEARS.

COMPLETE IN-HOUSE MACHINE SHOP, POWDER COATING, LASER WELDING, & MARKING FINISHING, ELECTRONICS AND OPTICAL DEPARTMENTS

AREAS OF SPECIALTY

- LAPAROSCOPIC AND ENDOSCOPIC INSTRUMENTS
- ELECTROSURGICAL UNITS AND ACCESSORIES
- FIBER OPTIC LIGHT CABLES AND RETRACTORS
- RIGID ENDOSCOPES & FLEXIBLE SINUSCOPES
- STAINLESS STEEL HAND INSTRUMENTS
- LIGHT SOURCES AND HEADLIGHTS
- DEBRIDER UNITS, HAND PIECES AND BLADES
- SELF RETAINING RETRACTOR SYSTEMS

HOW TO PACKAGE AND SHIP INSTRUMENTS

- **IMPORTANT:** ELMED CANNOT ACCEPT INSTRUMENTS THAT HAVE NOT BEEN PROPERLY CLEANED, DISINFECTED OR STERILIZED.
- INCLUDE CUSTOMER NAME AND ALL CONTACT INFORMATION (NAME, ADDRESS, PHONE NO., FAX NO., EMAIL ADDRESS, ETC.)
- INCLUDE CUSTOMER P.O. (PURCHASE ORDER), IF USED
- INCLUDE REASON FOR RETURN - BRIEF DESCRIPTION OF REPAIR PROBLEM IF AVAILABLE
- WRAP INSTRUMENT FOR PROTECTION DURING TRANSPORT
- USE A COMMON CARRIER SUCH AS UPS OR FEDEX
- INSURE THE PACKAGE AND RECORD THE TRACKING NUMBER

PLEASE FILL OUT, DETACH, AND INCLUDE THE FORM BELOW WITH YOUR REPAIR:

FROM:	
FACILITY:	CONTACT PERSON:
ADDRESS:	
CITY, STATE, ZIP	
EMAIL:	PHONE NO.
PO. NO.	QTY.

INSTRUMENT DESCRIPTION:

(NOTE: PLEASE INCLUDE MODEL NO. AND SERIAL NO. IN INSTRUMENT DESCRIPTION FOR SCOPES)

FAST SERVICE: INCOMING REPAIRS COMING IN BY NEXT DAY AIR WILL BE COMPLETED WITHIN 24 HRS (WHEN PARTS ARE AVAILABLE)

SHIP TO: **ELMED** 35 N BRANDON DR., GLENDALE HEIGHTS, IL 60139