

ELMED

SERVING THE MEDICAL PROFESSION SINCE 1955



WE DESIGN, MANUFACTURE, & SELL THE TOOLS THE SURGEONS USE

ELMED INC.
35 N. BRANDON DR.
GLENDALE HEIGHTS,
IL 60139
USA

WE SUBSCRIBE TO
COST CONTAINMENT
AND PROTECTION
OF THE ENVIRON-
MENT



MADE IN THE USA

THEREFORE, WE
MANUFACTURE REUS-
ABLE PRODUCTS FOR
A CLEANER WORLD

PH (224) 353-6446
FAX (224) 653-8178
EMAIL:
MEDICAL@ELMED.COM
WWW.ELMED.COM

TABLE OF CONTENTS

UROLOGY	PAGE
ENDO UROSCOPES	1
CYSTOSCOPY	PAGE
TELESCOPE BRIDGES	2
FLEXIBLE AND SEMI-RIGID INSTRUMENTS	3-5
FLEXIBLE ELECTRODES	6
VISUAL OBTURATORS	7
LITHOTRIPSY	PAGE
STONE PUNCH	8
SHEATH	8
TELESCOPE BRIDGE	8
ADAPTERS	8
RESECTOSCOPY	PAGE
WORKING ELEMENTS - PASSIVE AND ACTIVE CUTTING	9
MONOPOLAR ELECTRODES	10
CONTINUOUS FLOW SHEATHS (FOR USE WITH Ø 4.0 MM SCOPE)	11
IRRIGATION/SUCTION SHEATHS (FOR USE WITH Ø 4.0 MM SCOPE)	12
OBTURATOR (FOR USE WITH Ø 4.0 MM SCOPE)	13
CONTINUOUS FLOW SHEATHS (FOR USE WITH Ø 2.7 MM SCOPE)	14
ELECTRODE STERILIZATION PROTECTION TUBE	14
URETHROTOMY	PAGE
ENDO URO-SCOPES AND PASSIVE CUTTING	15
SHEATHS AND OBITURATORS	16
URETERO RENOSCOPY	PAGE
SEMI-RIGID INSTRUMENTS	17
FLEXIBLE AND SEMI-RIGID INSTRUMENTS	18
ACCESSORIES	18
URETHROTOME DILATORS	PAGE
OTIS URETHROTOME DILATOR	19
KOLLMANN URETHROTOME DILATOR	19
PEDIATRIC CYSTOSCOPY	PAGE
PEDIATRIC URETHROSCOPES	20
PEDIATRIC CYSTOSCOPE & URETHROSCOPE SHEATHS	20
ALBARRAN DEFLECTOR	21
PEDIATRIC CYSTOSCOPY FLEXIBLE & SEMI-RIGID INSTRUMENTS	21
FLEXIBLE MONOPOLAR ELECTRODES	21

PEDIATRIC URETHROTOMY	PAGE
URETHROTOME WORKING ELEMENT	22
URETHROTOME SHEATH	22
COLD KNIVES	22
PEDIATRIC RESECTOSCOPY	PAGE
WORKING ELEMENTS - PASSIVE	23
RESECTOSCOPE SHEATHS	23
MONOPOLAR ELECTRODES	23
PERCUTANEOUS NEPHROSTOMY	PAGE
NEPHROSCOPE 45° AND 90°	24
OUTER SHEATH	25
SHEATH OBTURATOR	25
FORCEPS — SPRING HANDLE	26
FORCEPS — SCISSOR STYLE HANDLE	27
TELESCOPE DILATOR	27
NEPHROSCOPE	28
OUTER SHEATHS — ROTATABLE/RIGID	28
OBTURATOR	28
STONE DISLODGER	29
LASER CYSTOSCOPY	PAGE
LASER WORKING ELEMENT	30
ADAPTER FOR WORKING ELEMENT	30
LASER CYSTOSCOPY SHEATH	30
TELESCOPE BRIDGE	31
VISUAL/STANDARD OBTURATOR	31
PUNCH FORCEPS	31
ENDO UROLOGY ACCESSORIES	PAGE
ELLIK EVACUATOR /PARTS	32
LUER LOCK TUBE CONNECTOR	33
STOPCOCK WITH LUER LOCK	33
UROLOGICAL INSTRUMENTS	PAGE
DILATING BOUGIES	34-35
CATHETER GUIDE	36
GOODWIN STYLE DILATION SOUNDS	37

MAGILL CATHETER INTRODUCING FORCEPS	38
FOREIGN BODY FORCEPS	39
CAPSULE HOLDING FORCEPS	40
BLADDER SPATULAS	41
BLADDER RETRACTORS	42
URETHRO DILATORS AND FORCEPS	43
STONE FORCEPS AND PROBES	44
VASECTOMY SCISSORS	45
CIRCUMCISION CLAMPS	46
TURNER WARWICK PEDIATRIC/PERINEAL RETRACTOR	47
TURNER WARWICK ADULT RETRACTOR	48
DENNIS BROWN ADULT & PEDIATRIC RETRACTOR SYSTEM	49
MEATUS AND INCONTINENCE CLAMPS	50
CAMPBELL SUPRAPUBIC TROCAR AND CANNULA	51
UROLOGICAL INSTRUMENTS - PROSTATECTOMY	PAGE
ROTH URETHRAL SUTURE GUIDES	52
LOWSLEY PROSTATIC TRACTOR	53
DURANI AND STAMEY	54
RETRACTORS FOR RETROPUBIC PROSTATECTOMY	55
UROLOGICAL ELECTROSURGERY	PAGE
FLEXIBLE ELECTRODES AND RIGID CYSTOSCOPES	56
CONTROL TIP ELECTRODES FOR RIGID CYSTOSCOPES	58
ELECTRODES FOR FLEXIBLE URETEROSCOPES AND FLEXIBLE CYSTOSCOPES	58
REUSABLE MONOPOLAR ELECTRODES	59
REUSABLE KYNAR-COATED SS MONOPOLAR ELECTRODES	60
BIPOLAR SURGICAL CUT-COAG SCISSORS	61
CYSTOSCOPY VIDEO SYSTEM	62
ELECTROSURGERY FOR UROLOGICAL PROCEDURES	63
ELMED HIVOCUATER ELECTROSURGICAL UNIT	64
ELMED ESU 170 U ELECTROSURGICAL UNIT	64
ELMED ESU 400 DIGITAL	65
SCALPEL BLADES AND HANDLES	PAGE
SURGICAL BLADES	66
SCALPEL HANDLES REUSABLE	66
ADVANCED URO-MINIMAL INVASIVE	PAGE
BULL CLAMP FOR LAPAROSCOPIC APPLICATION	67
SERVICE & REPAIR	PAGE
SERVICE AND REPAIR FORM	68



ENDO UROSCOPES HIGH DEFINITION OPTICS



MADE IN THE USA



DIAMETER	WORKING LENGTHS				
Ø 2.7 MM	302 MM	31270-00HD	31270-12HD	31270-30HD	31270-70HD
Ø 4.0 MM	302 MM	31400-00HD	31400-12HD	31400-30HD	31400-70HD

FEATURING

FULLY AUTOCLAVABLE - 134°C / 273°F - 18 MINUTES

GERMAN HD OPTIC SYSTEM

STORZ SCOPE LOCK (ACMI - WOLF - STRYKER - OLYMPUS AVAILABLE)

ACMI - WOLF - STORZ - OLYMPUS LIGHT CABLE CONNECTORS

CYSTOSCOPY SHEATHS

DUAL FIXED STOPCOCKS WITH LL ADAPTERS (FOR USE WITH Ø 4MM SCOPES)

SHEATH

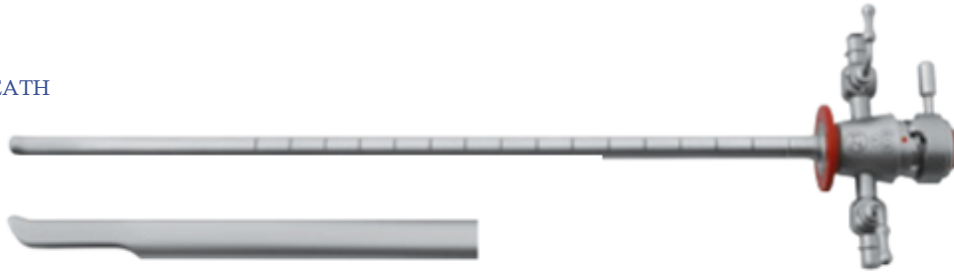

OBTURATOR



	Ø FOR SCOPES	COMPLETE SYSTEM	SHEATH ONLY	OBTURATOR ONLY
15 FR.	Ø 2.7 MM	31400-15	31400-15A	31400-15B
17 FR.	Ø 4.0 MM	31400-17	31400-17A	31400-17B
19 FR.	Ø 4.0 MM	31400-19	31400-19A	31400-19B
21 FR.	Ø 4.0 MM	31400-21	31400-21A	31400-21B
23 FR.	Ø 4.0 MM	31400-23	31400-23A	31400-23B
25 FR.	Ø 4.0 MM	31400-25	31400-25A	31400-25B



TO ORDER CALL: (224) 353-6446



CYSTOSCOPY-TELESCOPE BRIDGES



MADE IN THE USA



**TELESCOPE BRIDGE
FOR DIAGNOSTIC**

Ø 4.0 MM SCOPE	Ø 2.7 MM SCOPE
31400-55	31270-55

**TELESCOPE BRIDGE
WITH 1 INSTRUMENT CHANNEL**

Ø 4.0 MM SCOPE	Ø 2.7 MM SCOPE
31400-56	31270-56

**TELESCOPE BRIDGE
WITH 2 INSTRUMENT CHANNELS**

Ø 4.0 MM SCOPE	Ø 2.7 MM SCOPE
31400-57	31270-57

SEALING CAPS

52003-13



CYSTOSCOPY-WORKING ELEMENT WITH ALBARRAN DEFLECTOR

WORKING INSERT WITH ALBARRAN DEFLECTING MECHANISM, SAFETY PROBE & 1 INSTRUMENT

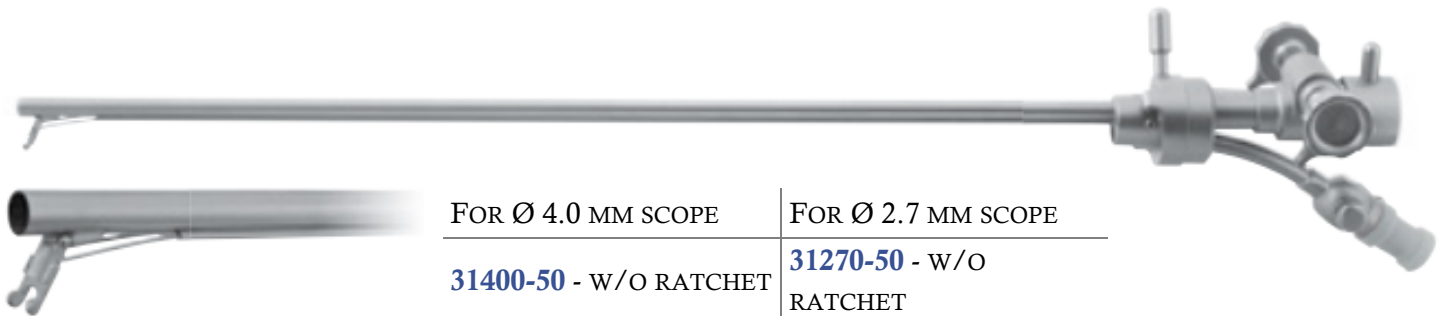

FOR Ø 4.0 MM SCOPE	FOR Ø 2.7 MM SCOPE
31400-50 - W/O RATCHET	31270-50 - W/O RATCHET
31400-51 - W/ RATCHET	—

WORKING INSERT WITH ALBARRAN DEFLECTING MECHANISM, SAFETY PROBE & 2 INSTRUMENT

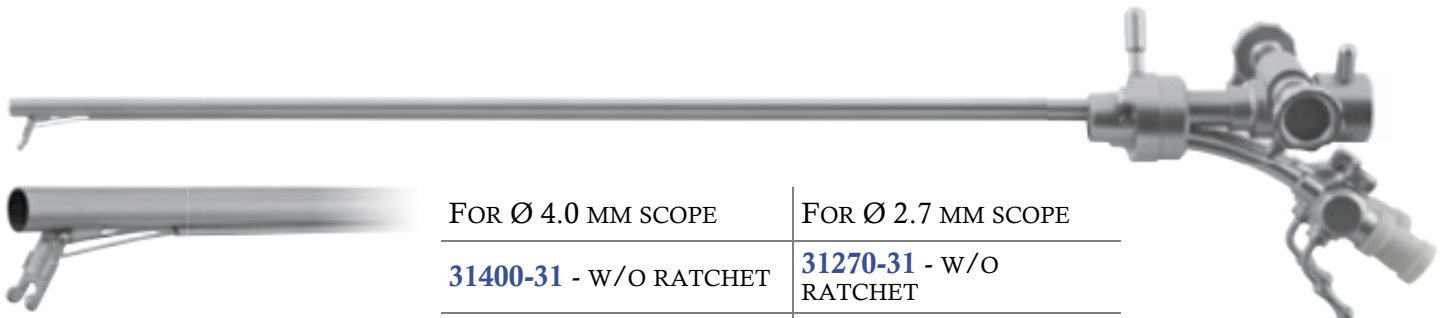

FOR Ø 4.0 MM SCOPE	FOR Ø 2.7 MM SCOPE
31400-31 - W/O RATCHET	31270-31 - W/O RATCHET
31400-32 - W/ RATCHET	—





CYSTOSCOPY FLEXIBLE AND SEMI-RIGID INSTRUMENTS



MADE IN THE USA



TIP SHAFT DIAMETER	FLEXIBLE		SEMI-RIGID		FLEXIBLE-INSULATED	
	x = 40 CM	x = 34 CM	x = 40 CM	x = 34 CM	x = 40 CM	x = 34 CM
3 FR.(1.0 MM)	31340-20	31334-20	31340-30	31334-30	31340-40	31334-40
5 FR. 1.6 MM)	31540-20	31534-20	31540-30	31534-30	31540-40	31534-40
7 FR.(2.3 MM)	31740-20	31734-20	31740-30	31734-30	31740-40	31734-40
9 FR.(3.0 MM)	31940-20	31934-20	31940-30	31934-30	31940-40	31934-40
3 FR(1.0MM)	31340-21	31334-21	31340-31	31334-31	31340-41	31334-41
5 FR.(1.6 MM)	31540-21	31534-21	31540-31	31534-31	31540-41	31534-41
7 FR.(2.3 MM)	31740-21	31734-21	31740-31	31734-31	31740-41	31734-41
9 FR.(3.0 MM)	31940-21 (60) FLEXI	31934-21 (010)	31940-31 (110)	31934-31 (60) RIGHT	31940-41 (010)	31934-41 (110)
3 FR.(1.0 MM)	31340-22	31334-22	31340-32	31334-32	31340-42	31334-42
5 FR.(1.6 MM)	31540-22	31534-22	31540-32	31534-32	31540-42	31534-42
7 FR.(2.3 MM)	31740-22	31734-22	31740-32	31734-32	31740-42	31734-42
9 FR.(3.0 MM)	31940-22	31934-22	31940-32	31934-32	31940-42	31934-42
5 FR. (1.6 MM)	31540-23	31534-23	31540-33	31534-33	31540-43	31534-43
7 FR.(2.3 MM)	31740-23	31734-23	31740-33	31734-33	31740-43	31734-43
9 FR.(3.0 MM)	31940-23	31934-23	31940-33	31934-33	31940-43	31934-43



**BIOPSY CUP FORCEPS
SINGLE ACTION**



**BIOPSY CUP FORCEPS
DOUBLE ACTION**



**BIOPSY CUP
FORCEPS
SERRATED**



**ALLIGATOR
GRASPING FORCEPS**



TO ORDER CALL: (224) 353-6446



CYSTOSCOPY FLEXIBLE AND SEMI-RIGID INSTRUMENTS



MADE IN THE USA

TIP SHAFT DIAMETER	FLEXIBLE		SEMI-RIGID		FLEXIBLE-INSULATED	
	X = 40 CM	X = 34 CM	X = 40 CM	X = 34 CM	X = 40 CM	X = 34 CM
3 FR.(1.0 MM)	31340-24	31334-24	31340-34	31334-34	31340-44	31334-44
5 FR.(1.6 MM)	31540-24	31534-24	31540-34	31534-34	31540-44	31534-44
7 FR.(2.3 MM)	31740-24	31734-24	31740-34	31734-34	31740-44	31734-44
9 FR.(3.0 MM)	31940-24	31934-24	31940-34	31934-34	31940-44	31934-44
5 FR.(1.6MM)	31540-25	31534-25	31540-35	31534-35	31540-45	31534-45
7 FR. 2.3MM)	31740-25	31734-25	31740-35	31734-35	31740-45	31734-45
9 FR.(3.0MM)	31940-25	31934-25	31940-35	31934-35	31940-45	31934-45
5 FR.(1.6MM)	31540-26	31534-26	31540-36	31534-36	31540-46	31534-46
7 FR. 2.3MM)	31740-26	31734-26	31740-36	31734-36	31740-46	31734-46
9 FR.(3.0MM)	31940-26	31934-26	31940-36	31934-36	31940-46	31934-46
3 FR.(1.0 MM)	31340-50	31334-50	31340-50	31334-51	31340-52	31334-52
5 FR.(1.6 MM)	31540-50	31534-50	31540-51	31534-51	31540-52	31534-52
7 FR.(2.3 MM)	31740-50	31734-50	31740-51	31734-51	31740-52	31734-52
9 FR.(3.0 MM)	31940-50	31934-50	31940-51	31934-51	31940-52	31934-52



METZ. SCISSORSS
SINGLE ACTION



METZ. SCISSORSS
DOUBLE ACTION



HOOX SCISSORS



FOREIGN BODY
GRASPERS
DOUBLE ACTION





CYSTOSCOPY FLEXIBLE AND SEMI-RIGID INSTRUMENTS



MADE IN THE USA

TIP SHAFT DIAMETER	FLEXIBLE		SEMI-RIGID		FLEXIBLE-INSULATED	
	X = 40 CM	X = 34 CM	X = 40 CM	X = 34 CM	X = 40 CM	X = 34 CM
3 FR. (1.0 MM)	31340-60	31334-60	31340-61	31334-61	31340-62	31334-62
5 FR. (1.6 MM)	31540-60	31534-60	31540-61	31534-61	31540-62	31534-62
7 FR. (2.3 MM)	31740-60	31734-60	31740-61	31734-61	31740-62	31734-62
9 FR. (3.0 MM)	31940-60	31934-60Q	31940-61	31934-61	31940-62	31934-62
3 FR. (1.0 MM)	31340-70	31334-70	31340-71	31334-71	31340-72	31334-72
5 FR. (1.6 MM)	31540-70	31534-70	31540-71	31534-71	31540-72	31534-72
7 FR. (2.3 MM)	31740-70	31734-70	31740-71	31734-71	31740-72	31734-72
9 FR. (3.0 MM)	31940-70	31934-70	31940-71	31934-71	31940-72	31934-72
3 FR. (1.0 MM)	31340-80	31334-80	31340-81	31334-81	31340-82	31334-82
5 FR. (1.6 MM)	31540-80	31534-80	31540-81	31534-81	31540-82	31534-82
7 FR. (2.3 MM)	31740-80	31734-80	31740-81	31734-81	31740-82	31734-82
9 FR. (3.0 MM)	31940-80	31934-80	31940-81	31934-81	31940-82	31934-82
3 FR. (1.0 MM)	31340-90	31334-90	31340-91	31334-91	31340-92	31334-92
5 FR. (1.6 MM)	31540-90	31534-90	31540-91	31534-91	31540-92	31534-92
7 FR. (2.3 MM)	31740-90	31734-90	31740-91	31734-91	31740-92	31734-92
9 FR. (3.0 MM)	31940-90	31934-90	31940-91	31934-91	31940-92	31934-92

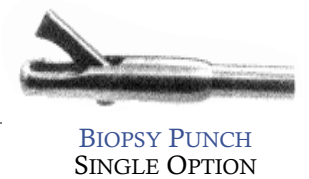

TO ORDER CALL: (224) 353-6446



CYSTOSCOPY FLEXIBLE ELECTRODES



MADE IN THE USA

FLEXIBLE MONOPOLAR COAGULATION ELECTRODE



SHAFT Ø FR. / MM	BALL ELECTRODE		NEEDLE ELECTRODE		LOOP ELECTRODE	
	X = 45 CM	X = 65 CM	X = 45 CM	X = 65 CM	X = 45 CM	X = 65 CM
3 FR. (1.0 MM)	31345-01	31365-01	31345-02	31365-02	---	---
4 FR. (1.3 MM)	31445-01	31465-01	31445-02	31465-02	---	---
5 FR. (1.6 MM)	31545-01	31565-01	31545-02	31565-02	31545-03	31565-03
6 FR. (2.0 MM)	31645-01	31665-01	---	---	---	---
7 FR. (2.3 MM)	31745-01	31765-01	31745-02	31765-02	31745-03	31765-03
8 FR. (2.6 MM)	31845-01	31865-01	---	---	---	---
9 FR. (3.0 MM)	31945-01	31965-01	---	---	31945-03	31965-03
10 FR. (3.3 MM)	31045-01	31065-01	---	---	31045-03	31065-03

FLEXIBLE "DORMIA" STONE DISLODGER

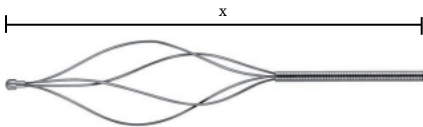

SHAFT Ø - FR. / MM	X = 70 CM	BASKET LENGTH	BASKET TYPE / WIRES
3 FR. (1.0 MM)	31370-05	20 MM	4
5 FR. (1.6 MM)	31570-05	30 MM	4
5 FR. (1.6 MM)	31571-05	40 MM	6
7 FR. (2.3 MM)	31770-05	40 MM	4

ITEM NO. **31000-05** HANDLE FOR DORMIA STONE DISLODGER

FLEXIBLE MONOPOLAR POLYP SNARE

SHAFT Ø - FR. / MM	X = 50 CM
5 FR. (1.6 MM)	31550-04
7 FR. (2.3 MM)	31750-04



ITEM NO. **31000-04** HANDLE FOR POLYP SNARE WITH MONOPOLAR RF CONNECTOR

FLEXIBLE INJECTION NEEDLE *

SHAFT Ø - FR. / MM	X = 50 CM
6 FR. (2.0 MM)	31650-06



* FOR USE WITH STANDARD SYRINGE





CYSTOSCOPY VISUAL OBTURATORS

FOR USE WITH Ø 4.0 MM SCOPE



MADE IN THE USA



CYSTOSCOPY VISUAL OBTURATORS

FOR USE W/ CYST-SHEATH

17 FR.		31417-73
19 FR.		31419-73
21 FR.		31421-73
23 FR.		31423-73
25 FR.		31425-73

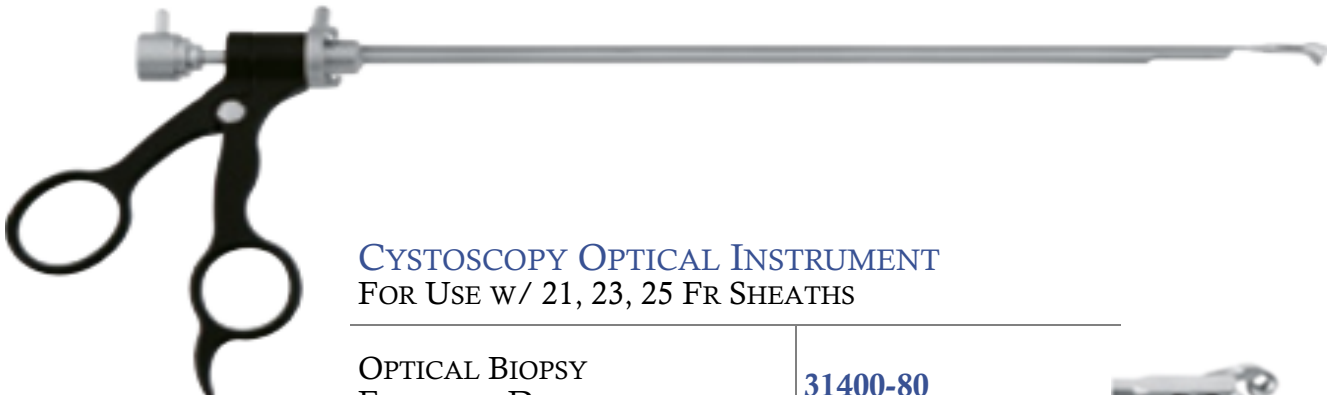

CYSTOSCOPY OPTICAL INSTRUMENT

FOR USE W/ 21, 23, 25 FR SHEATHS

OPTICAL BIOPSY FORCEPS - DOWN	31400-80	
OPTICAL BIOPSY PUNCH	31400-81	
OPTICAL BIOPSY PUNCH STRAIGHT	31400-82	
OPTICAL BIOPSY GRASPING FORCEPS	31400-83	
OPTICAL BIOPSY SCISSORS	31400-84	
STONE GRASPING FORCEPS FOR USE WITH 25 FR. SHEATH	31400-85	



TO ORDER CALL: (224) 353-6446



CYSTOSCOPY OPTICAL INSTRUMENTS - LITHOTRIPSY



MADE IN THE USA

LITHOTRIPSY WORKING ELEMENT STONE PUNCH — 24 FR.

FOR USE W/ Ø 4.MM SCOPE

31400-90



LITHOTRIPSY SHEATH & OBTURATOR

FOR **31400-90** WORKING ELEMENT

COMPLETE SYSTEM **31400-91**

SHEATH ONLY **31400-91A**

OBTURATOR ONLY **314-91B**



LITHOTRIPSY INNER VISUAL TELESCOPE BRIDGE W/ 7 FR. INSTRUMENT CHANNEL



FOR USE W/ **31400-91** SHEATH SYSTEM

31400-92

CYSTOSCOPY OPTICAL INSTRUMENT — ADAPTERS

ADAPTER FOR OPTICAL INSTRUMENTS
FOR USE W/ RESECTOSCOPE SHEATHS (FIGURE 1)

31400-88

ADAPTER
FOR USE W/ RESECTOSCOPE SHEATHS (FIGURE 2)

31400-89



FIGURE 1



FIGURE 2





RESECTOSCOPY WORKING ELEMENTS



MADE IN THE USA

WORKING ELEMENT — PASSIVE CUTTING

FOR USE WITH Ø 2.7 MM & Ø 4.0 MM SCOPES.



FOR Ø 4.0 MM SCOPE	FOR Ø 2.7 MM SCOPE
31300-61	31270-61



FOR Ø 4.0 MM SCOPE	FOR Ø 2.7 MM SCOPE
31300-60	31270-60

WORKING ELEMENT — ACTIVE CUTTING

FOR USE WITH Ø 2.7 MM & Ø 4.0 MM SCOPES.



FOR Ø 4.0 MM SCOPE	FOR Ø 2.7 MM SCOPE
31300-63	31270-63



FOR Ø 4.0 MM SCOPE	FOR Ø 2.7 MM SCOPE
31300-62	31270-62

WORKING ELEMENT REUSABLE MONOPOLAR RF CABLES

FOR USE WITH Ø 2.7 MM & Ø 4.0 MM SCOPES.

RESECTOSCOPE RF CABLE 4 MM MALE BANANA UNIT PLUG

52005-47



RESECTOSCOPE RF CABLE 8 MM "BOVIE" BANANA UNIT PLUG

52005-48



TO ORDER CALL: (224) 353-6446



RESECTOSCOPY WORKING ELEMENTS - MONOPOLAR ELECTRODES



MADE IN THE USA

(A) SINGLE-STEM MONOPOLAR ELECTRODE



Ø 4.0 MM SCOPE - 24 FR. + 27 FR

(B) DOUBLE-STEM MONOPOLAR ELECTRODE



Ø 2.7 MM SCOPE - 19 FR.

Ø 4.0 MM SCOPE - 24 FR. + 27 FR

		A - SINGLE STEM		B - DOUBLE STEM	
		REUSABLE QTY. (1)	STERILE DISPOSABLE (ST) BOX OF 6	REUSABLE QTY. (1)	STERILE DISPOSABLE (ST) BOX OF 6
	19 FR.	31270-19A	31270-19A-ST	---	---
	24 FR.	31300-20A	31300-20A-ST	31300-20B	31300-20B-ST
	27 FR.	31300-21A	31300-21A-ST	31300-21B	31300-21B-ST
	19 FR.	31270-20A	31270-20A-ST	---	---
	24 FR.	31300-22A	31300-22A-ST	31300-22B	31300-22B-ST
	27 FR.	31300-23A	31300-23A-ST	31300-23B	31300-23B-ST
	19 FR.	31270-21A	31270-21A-ST	---	---
	24 FR.	31300-24A	31300-24A-ST	31300-24B	31300-24B
	27 FR.	31300-25A	31300-25A-ST	31300-25B	31300-25B
	24 FR.	31300-26A	31300-26A-ST	31300-26B	31300-26B-ST
	27 FR.	31300-27A	31300-27A-ST	31300-27B	31300-27B-ST
	24 FR.	31300-28A	31300-28A-ST	31300-28B	31300-28B-ST
	27 FR.	31300-29A	31300-29A-ST	31300-29B	31300-29B-ST
	24 FR.	31300-30A	31300-30A-ST	31300-30B	31300-30B-ST
	27 FR.	31300-31A	31300-31A-ST	31300-31B	31300-31B-ST
	19 FR.	31270-22A	31270-22A-ST	---	---
	24 FR.	31300-32A	31300-32A-ST	31300-32B	31300-32B-ST
	27 FR.	31300-33A	31300-33A-ST	31300-33B	31300-33B-ST
	19 FR.	31270-23A	31270-23A-ST	---	---
	24 FR.	31300-34A	31300-34A-ST	31300-34B	31300-34B-ST
	27 FR.	31300-35A	31300-35A-ST	31300-35B	31300-35B-ST
	24 FR.	31300-36A	31300-36A-ST	31300-36B	31300-36B-ST
	27 FR.	31300-37A	31300-37A-ST	31300-37B	31300-37B-ST
	24 FR.	31300-38A	31300-38A-ST	31300-38B	31300-38B-ST
	27 FR.	31300-39A	31300-39A-ST	31300-39B	31300-39B-ST



ELECTRODE STERILIZATION PROTECTION TUBE
31300-40



WE DESIGN, MANUFACTURE & SELL THE TOOLS THE SURGEONS USE



RESECTOSCOPY SHEATHS— CONTINUOUS FLOW

FOR USE W/ Ø 4.0 MM SCOPE



MADE IN THE USA

	24/26 FR. SET
COMPLETE SET - 24/26 FR. - ROTATABLE CONTINUOUS FLOW SHEATH, OUTER AND INNER SHEATHS, AND STANDARD OBTURATOR	31300-65
OUTER SHEATH WITH DUAL STOPCOCKS - 26 FR.	31300-65A
INNER SHEATH WITH INSULATED BEAKS - 24 FR.	31300-65B
STANDARD OBTURATOR - 24 FR.	31300-65C



360° ROTATABLE — CONTINUOUS FLOW

	27/28.5 FR. SET
COMPLETE SET - 27/28.5 FR. - ROTATABLE CONTINUOUS FLOW SHEATH, OUTER AND INNER SHEATHS, AND STANDARD OBTURATOR	31300-66
OUTER SHEATH WITH DUAL STOPCOCKS - 28.5 FR.	31300-66A
INNER SHEATH WITH INSULATED BEAKS - 27 FR.	31300-66B
STANDARD OBTURATOR - 27 FR.	31300-66C

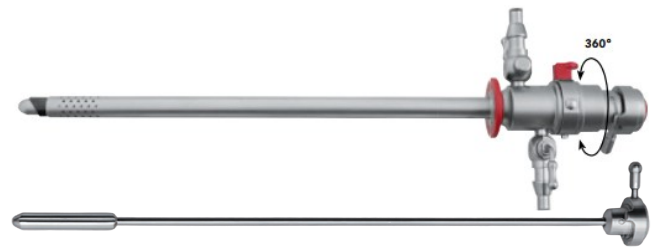

	24/26 FR. SET
COMPLETE SET - 24/26 FR. - NON-ROTATABLE CONTINUOUS FLOW SHEATH, OUTER AND INNER SHEATHS, AND STANDARD OBTURATOR	31300-67
OUTER SHEATH WITH DUAL STOPCOCKS - 26 FR.	31300-67A
INNER SHEATH WITH INSULATED BEAKS - 24 FR.	31300-67B
STANDARD OBTURATOR - 24 FR.	31300-65C



NON-ROTATABLE — CONTINUOUS FLOW

	27/28.5 FR. SET
COMPLETE SET - 27/28.5 FR. - NON-ROTATABLE CONTINUOUS FLOW SHEATH, OUTER AND INNER SHEATHS, AND STANDARD OBTURATOR	31300-68
OUTER SHEATH WITH DUAL STOPCOCKS - 28.5 FR.	31300-68A
INNER SHEATH WITH INSULATED BEAKS - 27 FR.	31300-68B
STANDARD OBTURATOR - 27 FR.	31300-66C

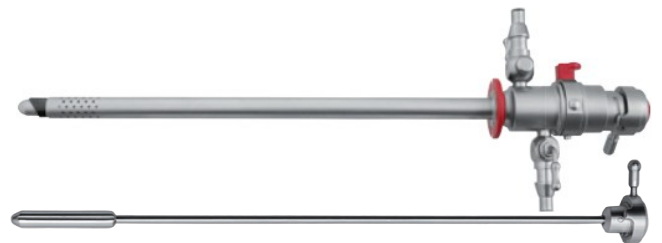



RESECTOSCOPY SHEATHS - IRRIGATION/SUCTION



MADE IN THE USA

IRRIGATION/SUCTION SHEATH WITH OBLIQUE TIP

FOR USE WITH Ø 4.0 MM SCOPE.



	24 Fr. Set
COMPLETE SET - 24 FR. - IRRIGATION/SUCTION SHEATH WITH OBLIQUE TIP, OUTER SHEATH, AND STANDARD OBTURATOR	31300-70
SHEATH WITH (1) STOPCOCK AND OBLIQUE TIP - 24 FR.	31300-70A
STANDARD OBTURATOR - 24 FR.	31300-65C
	27 FR. SET
COMPLETE SET - 27 FR. - IRRIGATION/SUCTION SHEATH WITH	31300-71
SHEATH WITH (1) STOPCOCK AND OBLIQUE TIP - 27 FR.	31300-71A
STANDARD OBTURATOR - 27 FR.	31300-66C

IRRIGATION/SUCTION SHEATH WITH SHORT BEAK

FOR USE WITH Ø 4.0MM SCOPE

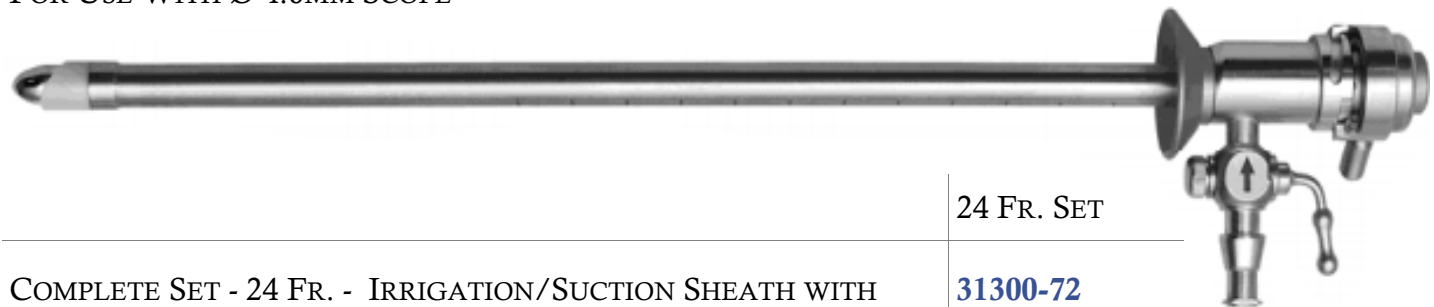

	24 FR. SET
COMPLETE SET - 24 FR. - IRRIGATION/SUCTION SHEATH WITH	31300-72
SHEATH WITH (1) STOPCOCK AND OBLIQUE TIP - 24 FR.	31300-72A
STANDARD OBTURATOR - 24 FR.	31300-65C
	2 FR. SET
COMPLETE SET - 27 FR. - IRRIGATION/SUCTION SHEATH WITH	31300-73
SHEATH WITH (1) STOPCOCK AND OBLIQUE TIP - 27 FR.	31300-73A
STANDARD OBTURATOR - 27 FR.	31300-66C





RESECTOSCOPY SHEATH OBTURATORS

FOR USE W/ Ø 4.0MM SSCOPE



MADE IN THE USA

STANDARD OBTURATOR



24 FR.

27 FR.

STANDARD RESECTOSCOPY SHEATH OBTURATOR

31300-65C

31300-66C

DEFLECTING OBTURATOR



24 FR.

27 FR.

DEFLECTING RESECTOSCOPY SHEATH OBTURATOR

31300-80

31300-81

VISUAL OBTURATOR



24 FR.

27 FR.

VISUAL RESECTOSCOPY SHEATH OBTURATOR

31300-82

31300-83

VISUAL OBTURATOR W/ (1) INST. CHANNEL



VISUAL RESECTOSCOPY SHEATH OBTURATOR W/ 5 FR. INST. CHANNEL - 24 FR.

31300-84

VISUAL RESECTOSCOPY SHEATH OBTURATOR W/ 7 FR. INST. CHANNEL - 27 FR.

31300-85



TO ORDER CALL: (224) 353-6446



RESECTOSCOPY SHEATHS

(FOR USE WITH Ø 2.7 MM SCOPE)



MADE IN THE USA

360° ROTATABLE - CONTINUOUS FLOW SHEATH

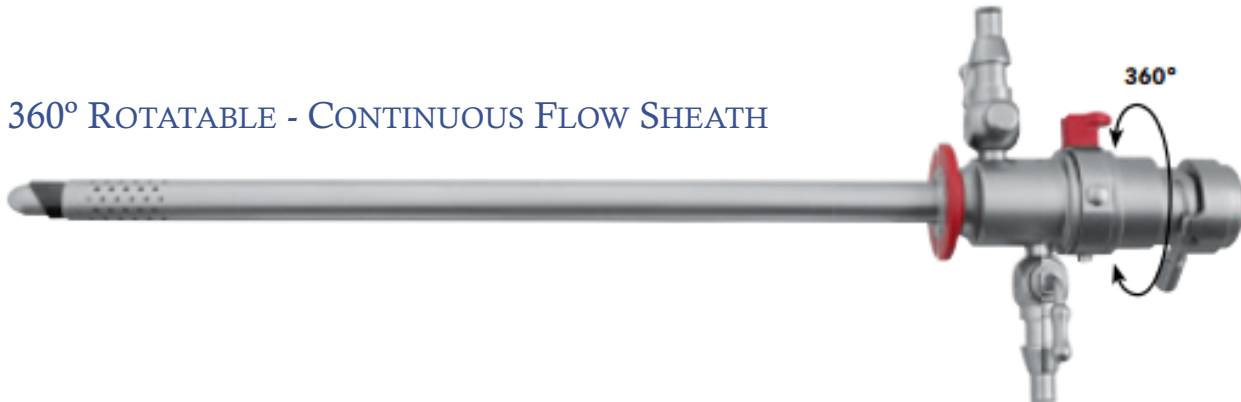

19/22 FR. SET

COMPLETE SET - 19/22 FR. - ROTATABLE CONTINUOUS FLOW SHEATH, OUTER AND INNER SHEATHS, AND STANDARD OBTURATOR

31270-65

OUTER SHEATH WITH DUAL STOPCOCKS - 22 FR.

31270-65A

INNER SHEATH WITH INSULATED BEAKS - 19 FR.

31270-65B

STANDARD OBTURATOR - 19 FR.

31270-65C

IRRIGATION/SUCTION SHEATH WITH OBLIQUE TIP



19 FR. SET

COMPLETE SET - 19 FR. - IRRIGATION/SUCTION SHEATH WITH OBLIQUE TIP AND STANDARD OBTURATOR

31270-70

SHEATH WITH (1) STOPCOCK AND OBLIQUE TIP - 19 FR.

31270-70A

STANDARD OBTURATOR - 19 FR.

31270-65C

VISUAL OBTURATOR



19 FR.

VISUAL RESECTOSCOPY SHEATH OBTURATOR

31270-82





URETHROTOMY





MADE IN THE USA

ENDO URO-SCOPES - HIGH DEFINITION OPTICS



FEATURING:

- FULLY AUTOCLAVABLE - 134°C/273° - 18 MIN.
- GERMAN HD OPTIC SYSTEM
- STORZ SCOPE LOCK
- ACMI/WOLF/STORZ-OLYMPUS LIGHT CABLE CONNECTOR
- MADE BY ELMED IN THE USA

DIA.	WORKING		
Ø 4.0MM	302MM	31400-00HD	31400-12HD

WORKING ELEMENT - PASSIVE CUTTING



WORKING ELEMENT PASSIVE CUTTING -
OPEN HANDLE

31300-60

SINGLE STEM COLD KNIVES FOR USE W/ **31300-60**



ROUND	STRAIGHT	WAVE CUT	RING SHAPED	HOOK SHAPED
31300-41	31300-42	31300-43	31300-44	31300-45



TO ORDER CALL: (224) 353-6446



URETHROTOMY



MADE IN THE USA

URETHROTOME SHEATHS

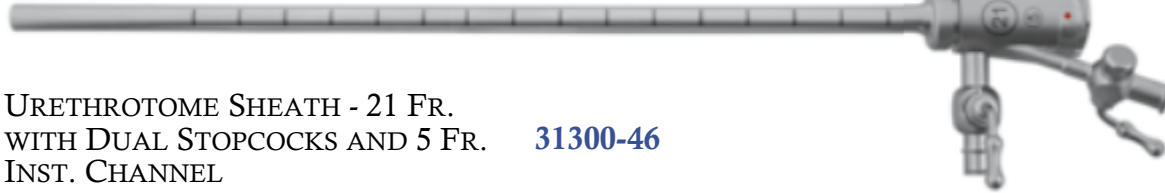

URETHROTOME SHEATH - 21 FR.
WITH DUAL STOPCOCKS AND 5 FR.
INST. CHANNEL **31300-46**

URETHROTOME OBTURATORS



URETHROTOME STANDARD OBTURATOR - 21 FR. **31300-47**

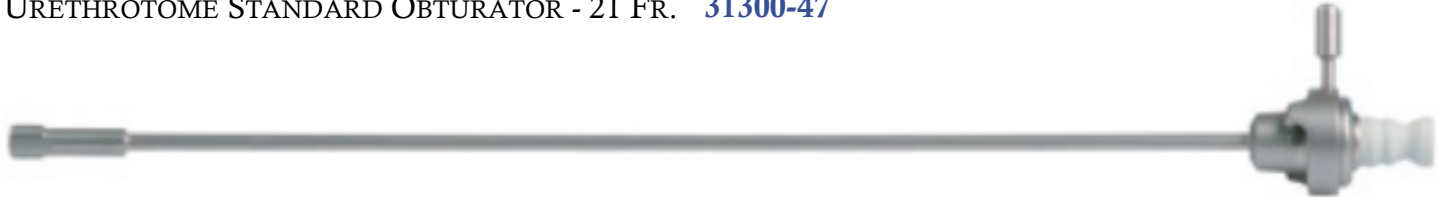

URETHROTOME OBTURATOR W/ 5 FR. INST. CHANNEL **31300-48**



URETHROTOME VISUAL OBTURATOR **31300-49**



GUIDE TUBE FOR INSERTION OF BALLOON CATHETER **31300-50**

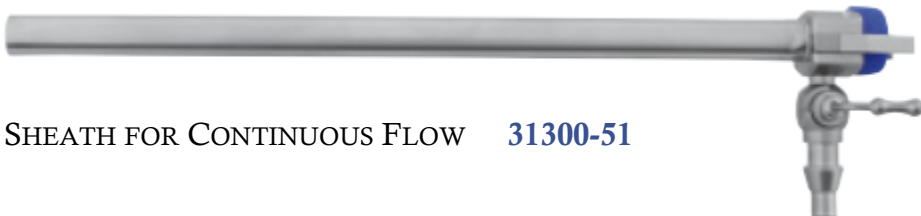

SHEATH FOR CONTINUOUS FLOW **31300-51**

TELESCOPE BRIDGE



TELESCOPE
BRIDGE W/ 5 FR. **31300-56**





URETERO-RENOSCOPY



MADE IN THE USA

SEMI-RIGID UTERO-RENOSCOPE

8° VIEWING FIBER OPTIC TECHNOLOGY W/ EXCELLENT RESOLUTION INSTRUMENT BRIDGE

- FULLY AUTOCLAVABLE - 134° C/273° F - 18 MIN.
- 45° EYEPIECE
- ACMI - WOLF - STORZ - OLYMPUS LIGHT CABLE
- CONNECTOR
- 2 INSTRUMENT CHANNELS
- MADE IN GERMANY

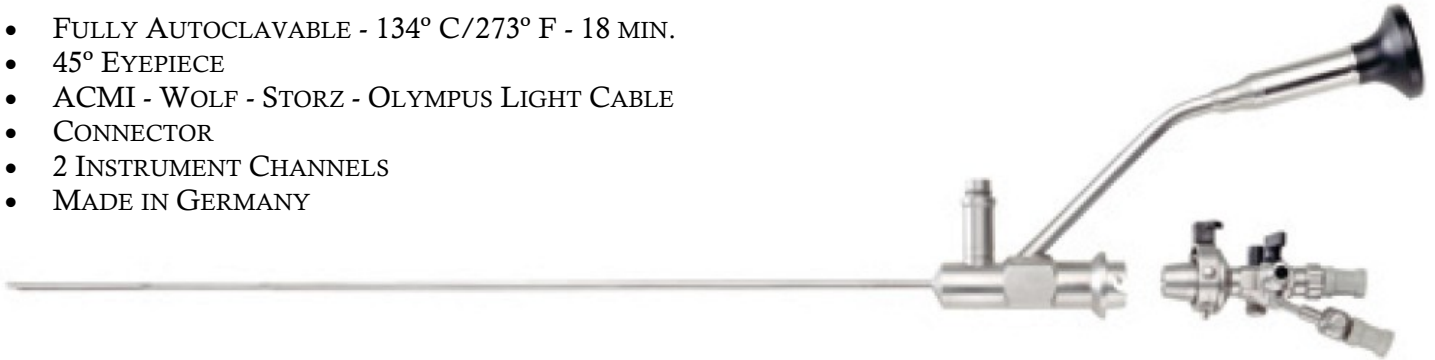

DIAMETER	WORKING LENGTH	2 INSTRUMENT CHANNEL	ITEM NO.
Ø 6 MM (7.5 FR.)	425 MM	1 X 4 FR. OR 2 X 2.4 FR.	31790-390
Ø 6 MM (7.5 FR.)	310 MM	1 X 4 FR. OR 2 X 2.4 FR.	31790-391
Ø 7.5 MM (9.8 FR.)	425 MM	1 X 5 FR. OR 2 X 3 FR.	31790-380
Ø 7.5 MM (9.8 FR.)	310 MM	1 X 5 FR. OR 2 X 3 FR.	31790-381

SEMI-RIGID UTERO-RENOSCOPE

8° VIEWING FIBER OPTIC TECHNOLOGY W/ EXCELLENT RESOLUTION



DIAMETER	WORKING LENGTH	INSTRUMENT CHANNEL	ITEM NO.
Ø 6 MM (7.5 FR.)	425 MM	1 X 4 FR.	31790-392
Ø 6 MM (7.5 FR.)	310 MM	1 X 4 FR.	31790-393
Ø 7.5 MM (9.8 FR.)	425 MM	1 X 5 FR.	31790-394
Ø 7.5 MM (9.8 FR.)	310 MM	1 X 5 FR.	31790-395

- FULLY AUTOCLAVABLE - 134° C/273° F - 18 MIN.
- STRAIGHT EYEPIECE
- ACMI - WOLF - STORZ - OLYMPUS LIGHT CABLE CONNECTOR
- SINGLE INSTRUMENT CHANNEL
- MADE IN GERMANY



SEALING CAP FOR INSTRUMENT CHANNEL (PKG. 10)

52003-13



TO ORDER CALL: (224) 353-6446









URETERO-RENOSCOPY

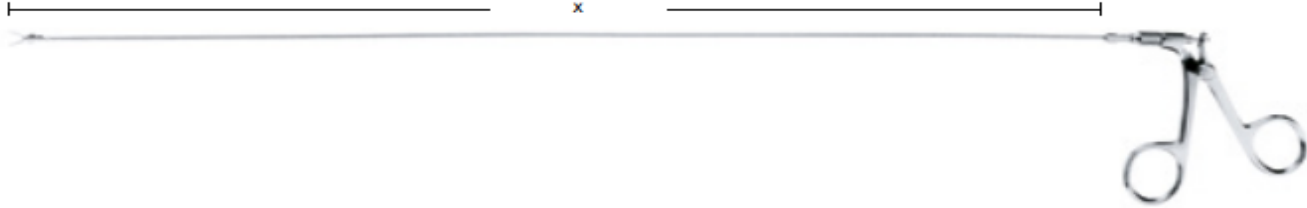

MADE IN THE USA

URETERO-RENOSCOPY FLEXIBLE & SEMI-RIGID INSTRUMENTS



	TIP & SHAFT DIAMETER	FLEXIBLE X = 60 CM	SEMI-RIGID X = 60 CM
	3 FR. (1.0 MM)	31360-22	31360-32
	5 FR. (1.6 MM)	31560-22	31560-32
	3 FR. (1.0 MM)	31360-50	31360-51
	5 FR. (1.6 MM)	31560-50	31560-51
	3 FR. (1.0 MM)	31360-23	31360-33
	5 FR. (1.6 MM)	31560-23	31560-33
	3 FR. (1.0 MM)	31360-24	31360-24
	5 FR. (1.6 MM)	31560-24	31560-24
	3 FR. (1.0 MM)	31360-60	31360-61
	5 FR. (1.6 MM)	31560-60	31560-61



INSTRUMENT BRIDGE FOR
ITEM NO. **31790-80** & **31790-81**

31790-90



SEALING CAP FOR
INSTRUMENT CHANNEL
(PKG. 10)

52003-13



ADAPTER FOR USE OF
EMS-LITHOTRIPTER LC1

31790-98



ADAPTER FOR USE OF
EMS-LITHOTRIPTER LC2

31790-99



REUSABLE CLEANING BRUSH

Ø 1.6 MM | X = 60 CM | **31790-01**





URETHROTOME DILATORS



MADE IN THE USA

OTIS URETHROTOME DILATOR

ITEM NO. **31423-00** OTIS URETHROTOM

COMPLETE SYSTEM IN WOODEN CASE
CONSISTING OF:

- (1) DILATOR
- (2) BLADES
- (1) CONICAL TIP
- (1) FLAT TIP
- (1) BALL TIP



KOLLMANN URETHROTOM DILATOR

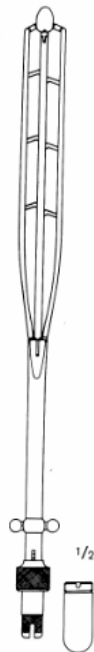
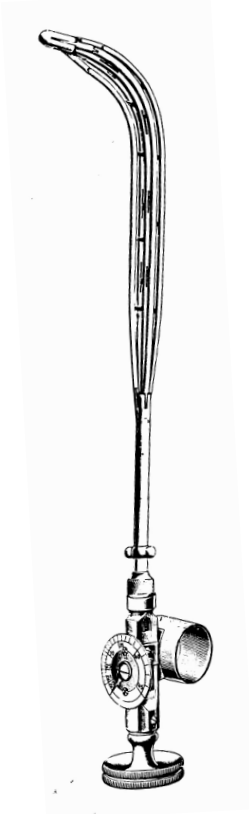

31-46-23
STRAIGHT,
LONG



31-44-23
STRAIGHT,
SHORT

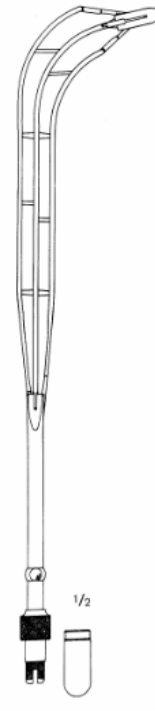

31-49-23
CURVED,
LONG

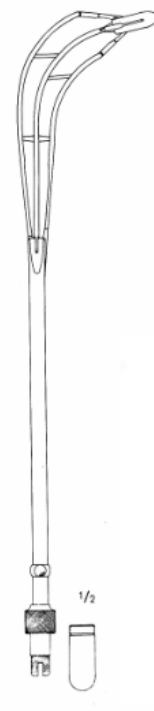

31-47-23
CURVED,
SHORT

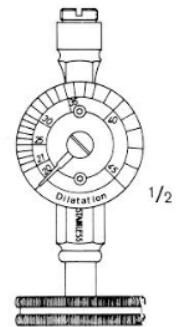

31-50-00
HANDLE



TO ORDER CALL: (224) 353-6446



PEDIATRIC CYSTOSCOPY



MADE IN THE USA

PEDIATRIC UROSCOPES - HIGH DEFINITION OPTICS



FEATURING:

- FULLY AUTOCLAVABLE - 134° C/273° F - 18 MIN.
- GERMAN HD OPTICS SYSTEM
- STORZ SCOPE LOCK
- ACMI - WOLF - STORZ - OLYMPUS LIGHT CABLE CONNECTORS
- MADE IN THE USA BY ELMED

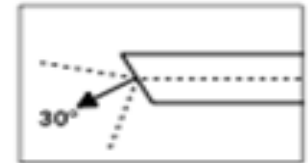
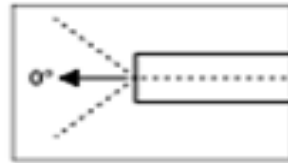



DIAMETER	WORKING LENGTHS		
Ø 1.9 MM	187.5 MM	P31190-00HD	P31190-30HD
Ø 2.7 MM	187.5 MM	P31270-00HD	P31270-30HD

PEDIATRIC CYSTOSCOPE & URETHROSCOPE SHEATHS W/ DUAL FIXED STOPCOCKS & ONE INSTRUMENT CHANNEL



SHEATHS & OBTURATORS ONE INSTRUMENT CHANNEL FOR 3 FR. (Ø 1.0 MM) INSTRUMENTS

SHEATH DIAMETER		INSTRUMENT CHANNEL	SCOPE DIAMETER	SHEATH & OBTURATOR
9.5 FR.		1 x 3 FR. (Ø 1.0 MM)	Ø 1.9 MM	P31793-10
11 FR.		1 x 3 FR. (Ø 1.0 MM)	Ø 2.7 MM	P31793-11
13 FR.		1 x 3 FR. (Ø 1.0 MM)	Ø 2.7 MM	P31793-13





PEDIATRIC CYSTOSCOPY



MADE IN THE USA

WORKING INSERT W/ ALBARRAN DEFLECTOR

SHEATH DIAMETER	SCOPE DIAMETER	WORKING INSERT & OBTURATOR
13 FR.	Ø 2.7 MM	P31793-52





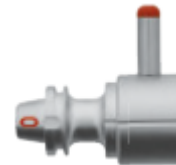

ALBARRAN WORKING INSERT SCOPE ADAPTER

SHEATH DIAMETER	SCOPE DIAMETER	ADAPTER
13 FR.	Ø 2.7 MM	P31793-40

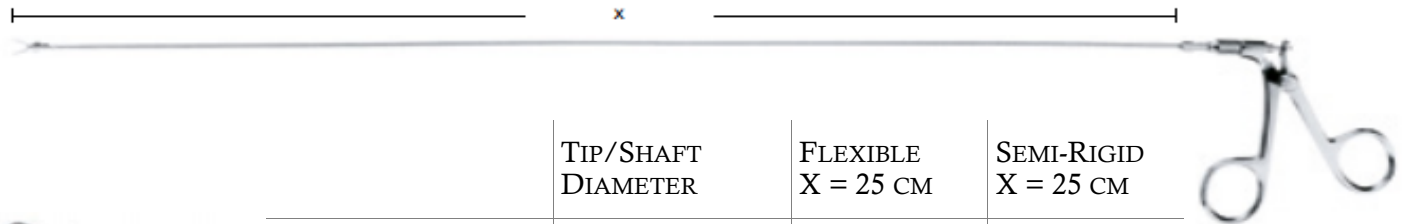

PEDIATRIC CYSTOSCOPY FLEXIBLE & SEMI-RIGID INSTRUMENTS



		TIP/SHAFT DIAMETER	FLEXIBLE X = 25 CM	SEMI-RIGID X = 25 CM
	BIOPSY CUP FORCEPS	3 FR. (Ø 1.0 MM)	31325-21	31325-31
	BIOPSY CUP FORCEPS - SERRATED	3 FR. (Ø 1.0 MM)	31325-22	31325-32
	ALLIGATOR GRASPING FORCEPS	3 FR. (Ø 1.0 MM)	31325-23	31325-33
	METZ SCISSORS SINGLE ACTION	3 FR. (Ø 1.0 MM)	31325-24	31325-34

PEDIATRIC FLEXIBLE MONOPOLAR ELECTRODES



SHAFT DIAMETER	BALL ELECTRODE X = 25 CM	NEEDLE ELECTRODE X = 25 CM
3 FR. (Ø 1.0 MM)	31325-01	31325-02

PEDIATRIC OPTICAL FORCEPS



RIGID OPTICAL BIOPSY FORCEPS	RIGID OPTICAL GRASPING FORCEPS
31190-45	31190-46



TO ORDER CALL: (224) 353-6446



PEDIATRIC URETHROTOMY



MADE IN THE USA

URETHROTOME WORKING ELEMENT - PASSIVE CUTTING FOR USE WITH PEDIATRIC UROSCOPES Ø 1.9 MM & Ø 2.7 MM

SHEATH DIAMETER	SCOPE DIAMETER	SINGLE STEM PASSIVE - OPEN HANDLE
11 FR.	Ø 1.9 MM	P31793-00
13 FR.	Ø 2.7 MM	P31793-01

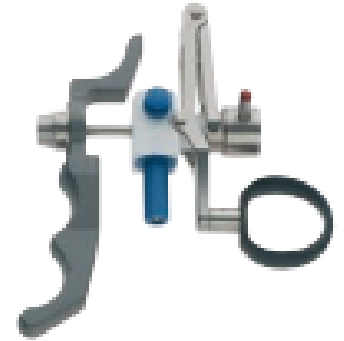

NOTE: DO **NOT** USE COLD KNIVES WITH HF POWER.

URETHROTOME SHEATHS - SINGLE STOPCOCK



	SHEATH	SCOPE DIAMETER	COMPLETE SET	SHEATH	OBTURATOR
ROTATABLE	11 FR.	Ø 1.9 MM	P31793-80	P31793-80A	P31793-80B
	13 FR.	Ø 2.7 MM	P31793-81	P31793-81A	P31793-81B
FIXED	11 FR.	Ø 1.9 MM	P31793-82	P31793-82A	P31793-82B
	13 FR.	Ø 2.7 MM	P31793-83	P31793-83A	P31793-83B



TELESCOPE BRIDGE W/
3 FR. INSTRUMENT CHANNEL

P31793-50

PEDIATRIC URETHROTOME WORKING ELEMENT SINGLE STEM COLD KNIVES



SHEATH DIAMETER	STRAIGHT	ROUND	HOOK	SICKLE
11 FR.	P31793-64	P31793-65	P31793-66	P31793-67
13 FR.	P31793-68	P31793-69	P31793-76	P31793-77





PEDIATRIC RESECTOSCOPY



MADE IN THE USA

RESECTOSCOPE WORKING ELEMENT - PASSIVE CUTTING
FOR USE WITH PEDIATRIC UROSCOPES Ø 1.9 MM & Ø 2.7 MM

SHEATH DIAMETER	SCOPE DIAMETER	SINGLE STEM PASSIVE - OPEN HANDLE
11 FR.	Ø 1.9 MM	P31793-00
13 FR.	Ø 2.7 MM	P31793-01

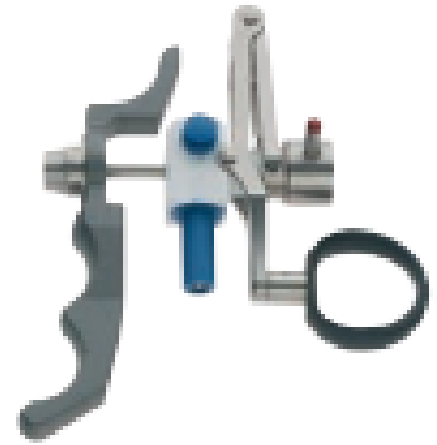

WORKING ELEMENT REUSABLE MONO RF CABLES

RESECTOSCOPE CABLE 4 MM BANANA UNIT PLUG	52005-47
RESECTOSCOPE CABLE 8 MM "BOVIE" BANANA UNIT PLUG	52005-48

RESECTOSCOPE SHEATHS - SINGLE STOPCOCK



	SHEATH	SCOPE DIAMETER	COMPLETE SET	SHEATH	OBTURATOR
ROTATABLE	11 FR.	Ø 1.9 MM	P31793-65	P31793-65A	P31793-65B
	13 FR.	Ø 2.7 MM	P31793-66	P31793-66A	P31793-66B
FIXED	11 FR.	Ø 1.9 MM	P31793-67	P31793-67A	P31793-67B
	13 FR.	Ø 2.7 MM	P31793-68	P31793-68A	P31793-68B

PEDIATRIC RESECTOSCOPE WORKING ELEMENT - MONOPOLAR ELECTRODES



SHEATH DIAMETER	KNIFE	LOOP	LOOP	BALL	BALL
11 FR. (Ø 1.9 MM)	P31793-19	P31793-22	P31793-25	P31793-28	P31793-31
13 FR. (Ø 2.7 MM)	P31793-20	P31793-23	P31793-26	P31793-29	P31793-32



TO ORDER CALL: (224) 353-6446



PERCUTANEOUS NEPHROSTOMY



MADE IN THE USA

- NEPHROSCOPE 0°
- RIGID WITH 45° ANGLED OCULAR
- INTEGRATED IRRIGATION/SUCTION CHANNEL
- INTEGRATED INSTRUMENT CHANNEL
- BRIGHT HIGH DEFINITION OPTICS
- FULLY AUTOCLAVABLE 134° C/ 273° F — 18 MINUTES

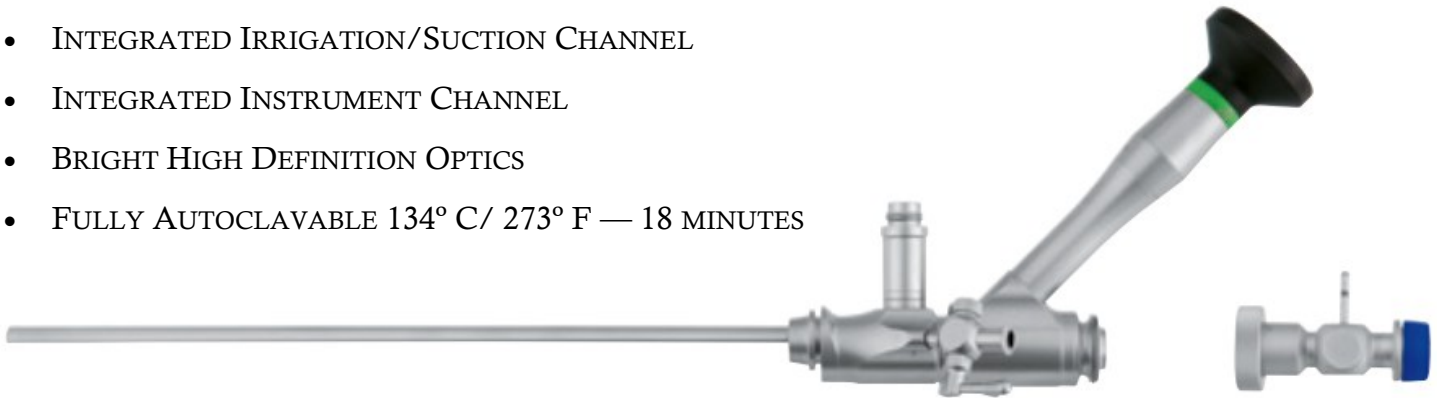

DIAMETER	WORKING LENGTH	INSTRUMENT	INCLUDED	ITEM NO.
Ø 7.45 MM	200 MM	Ø 3.5 MM	31700-243	31700-241

- NEPHROSCOPE 0°
- RIGID WITH 90° DOUBLE PRISM OCULAR
- INTEGRATED IRRIGATION/SUCTION CHANNEL
- INTEGRATED INSTRUMENT CHANNEL
- BRIGHT HIGH DEFINITION OPTICS
- FULLY AUTOCLAVABLE 134° C/ 273° F — 18 MINUTES

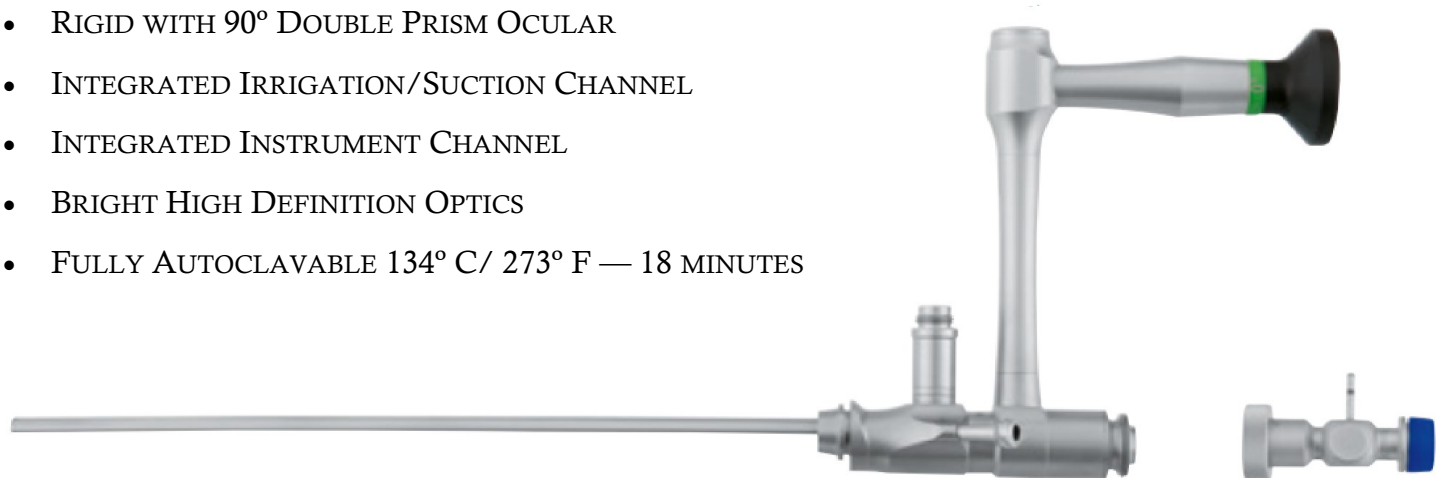

DIAMETER	WORKING LENGTH	INSTRUMENT CHANNEL	INCLUDED ADAPTOR	ITEM NO.
Ø 7.45 MM	200 MM	Ø 3.5 MM	31700-243	31700-242





PERCUTANEOUS NEPHROSTOMY



MADE IN THE USA

NEPHROSCOPE OUTER SHEATH — RIGID 1 STOPCOCK — CONTINUOUS FLOW CM DEPTH INDICATOR MARKINGS



DIAMETER	WORKING LENGTH	FOR SCOPE	ITEM NO.
24 FR.	200 MM	31700-241 / 31700-242	31791-280

NEPHROSCOPE OUTER SHEATH — ROTATABLE 1 STOPCOCK — CONTINUOUS FLOW CM DEPTH INDICATOR MARKINGS

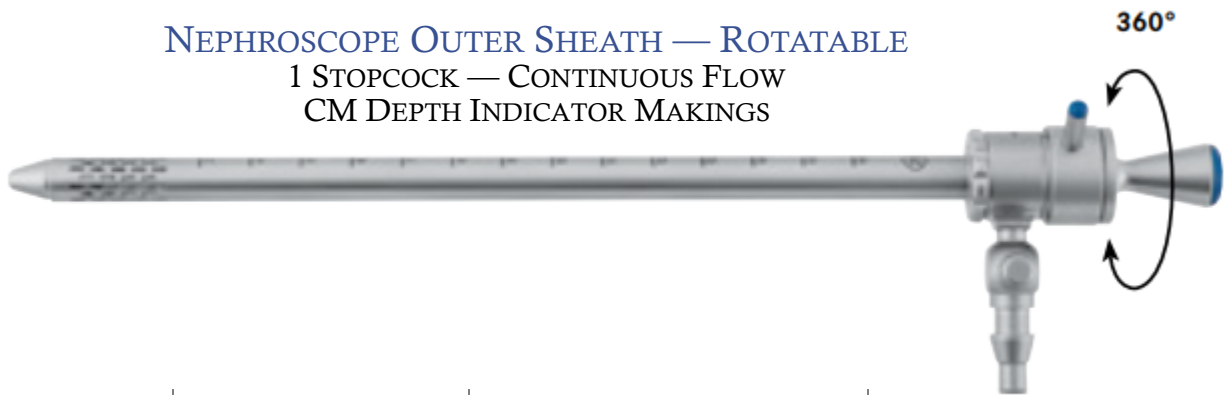

DIAMETER	WORKING LENGTH	FOR SCOPE	ITEM NO.
24 FR.	200 MM	31700-241 / 31700-242	31791-260

NEPHROSCOPE SHEATH OBTURATOR



DIAMETER	FOR SHEATH	ITEM NO.
24 FR.	31700-280	31791-281
26 FR.	31791-260	31791-261



TO ORDER CALL: (224) 353-6446



PERCUTANEOUS NEPHROSTOMY



MADE IN THE USA

NEPHROSCOPY FORCEPS

- RIGID - SPRING ACTION HANDLE
- MODULAR - FOR ENHANCED CLEANING
- REUSABLE - FULLY AUTOCLAVABLE

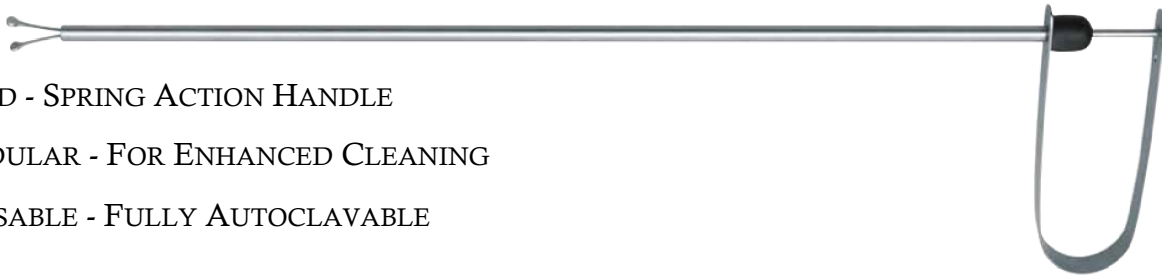

	ITEM NO.	Ø DIAMETER	WORKING LENGTH	DESCRIPTION
	31791-001	5 MM	330 MM	TRIPLE JAW GRASPING FORCEPS
	31791-002	5 MM	330 MM	GRASPING FORCEPS - ATRAUMATIC LARGE
	31791-003	5 MM	330 MM	GRASPING FORCEPS - ATRAUMATIC SMALL
	31791-004	5 MM	330 MM	TISSUE GRASPING FORCEPS
	31791-005	5 MM	330 MM	ATRAUMATIC FENESTRATED TIP FORCEPS
	31791-006	5 MM	330 MM	BOWEL FORCEPS
	31791-007	5 MM	330 MM	1 x 2 TOOTH GRASPING FORCEPS
	31791-008	5 MM	330 MM	MOUSE TOOTH GRASPING FORCEPS
	31791-009	5 MM	330 MM	FIMBRIA HOLDING FORCEPS
	31791-010	5 MM	330 MM	RING PATTERN FORCEPS
	31791-011	5 MM	330 MM	T-PATTERN FORCEPS
	31791-012	5 MM	330 MM	SQUARE TIP FORCEPS
	31791-013	5 MM	330 MM	ATRAUMATIC - CLOSED TIP FORCEPS





PERCUTANEOUS NEPHROSTOMY





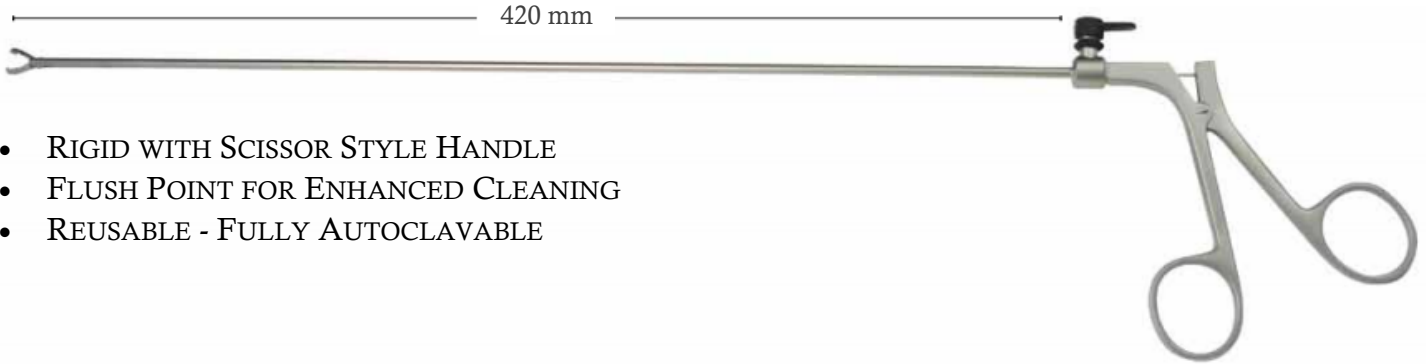

MADE IN THE USA

PERCUTANEOUS NEPHROSTOMY FORCEPS



- RIGID WITH SCISSOR STYLE HANDLE
- FLUSH POINT FOR ENHANCED CLEANING
- REUSABLE - FULLY AUTOCLAVABLE

	ITEM NO.	Ø DIAMETER	WORKING LENGTH	DESCRIPTION
	31791-141	3 MM	420 MM	BIOPSY FORCEPS - SPOON SINGLE ACTION
	31791-142	3 MM	420 MM	STONE FRAGMENTS GRASPING FORCEPS DOUBLE ACTION - FENESTRATED
	31791-143	3 MM	420 MM	STONE FRAGMENTS GRASPING FORCEPS DOUBLE ACTION - AGGRESSIVE
	31791-144	3 MM	420 MM	MICRO SCISSORS - STRAIGHT POINTED - SINGLE ACTION

NEPHROSTOMY TELESCOPE DILATOR



ITEM NO.	DESCRIPTION
31791-200	TELESCOPE DILATOR SET — (12) CONSISTING OF 1 X RIGID — 1 X FLEXIBLE 9, 12, 15, 18, 21, 24 FR.
31791-224	TELESCOPE DILATOR — RIGID — 27 FR.
31791-230	TELESCOPE DILATOR — RIGID — 30 FR.





PERCUTANEOUS NEPHROSTOMY



MADE IN THE USA

- NEPHROSCOPE 0°
- RIGID WITH 45° ANGLED OCULAR
- INTEGRATED INSTRUMENT CHANNEL
- BRIGHT HIGH DEFINITION OPTICS
- FULLY AUTOCLAVABLE 134° C/ 273° F — 18 MINUTES
- MADE IN GERMANY

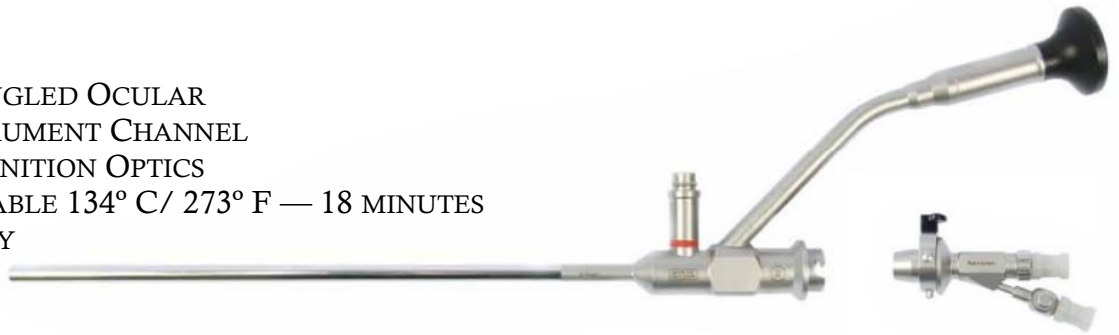

DIAMETER	WORKING LENGTHS	INSTRUMENT CHANNEL	INCLUDED ADAPTOR	ITEM NO.
13.5 CH	220 MM	4.7 MM	31419-000	31413-220
13.5 CH	220 MM	4.7 MM	31419-000	31413-320
19 CH	220 MM	4.7 MM	31419-000	31419-200

NEPHROSCOPE OUTER SHEATH-ROTATABLE

1 STOPCOCK — CONTINUOUS FLOW
CM DEPTH INDICATOR MARKINGS



DIAMETER	WORKING LENGTH	FOR SCOPE	ITEM NO.
24 FR.	200 MM	31413-220/ 31413-320	31500-102
26 FR.	200 MM	31419-200	31500-126

NEPHROSCOPE OUTER SHEATH-RIGID

1 STOPCOCK — DISTAL DRAIN
CM DEPTH INDICATOR MARKINGS



DIAMETER	WORKING LENGTH	FOR SCOPE	ITEM NO.
24 FR.	200 MM	31413-220/ 31413-320	31500-100
26 FR.	200 MM	31419-200	31500-123

NEPHROSCOPE OBTURATOR



DIAMETER	FOR SHEATH	ITEM NO.
24 FR.	31500-102/ 31500-100	31500-101
26 FR.	31500-126/ 31500-123	31500-121





PERCUTANEOUS NEPHROSTOMY



MADE IN THE USA

NEPHROSCOPIC STONE DISLODGER

- AVAILABLE IN 4-WIRE AND 6-WIRE BASKETS
- AVAILABLE WITH 2 HANDLE STYLES A + B
 - STAINLESS STEEL SEMI-RIGID SHAFT
- MODULAR 2-PIECE FOR ENHANCED CLEANING
 - REUSABLE — FULLY AUTOCLAVABLE



STYLE A HANDLE

SCISSOR STYLE — STAINLESS STEEL



STYLE B HANDLE

SYRINGE STYLE — AUTOCLAVABLE
THERMO-PLASTIC



TIP STYLE	HANDLE STYLE	Ø DIAMETER	WORKING LENGTH	ITEM No.
4 WIRE	A - SCISSOR	Ø 3 FR.	600 MM	31604-03 A
4 WIRE	B - SYRINGE	Ø 3 FR.	600 MM	31604-03 B
4 WIRE	A - SCISSOR	Ø 5 FR.	600 MM	31604-05 A
4 WIRE	B - SYRINGE	Ø 5 FR.	600 MM	31604-05 B
6 WIRE	A - SCISSOR	Ø 5 FR.	600 MM	31606-05 A
6 WIRE	B - SYRINGE	Ø 5 FR.	600 MM	31606-05 B



TO ORDER CALL: (224) 353-6446



LASER CYSTOSCOPY



MADE IN THE USA

LASER WORKING ELEMENT— 2 Ø FIBER CHANNELS

- PASSIVE ACTION
- CLOSED HANDLE
- FOR USE WITH 4 MM Ø SCOPES
- MADE IN GERMANY



ITEM NO.	USE WITH FIBERS Ø
31400-108	Ø 0.8 MM
31400-112	Ø 1.2 MM

ADAPTER FOR WORKING ELEMENT — INCLUDED WITH WORKING ELEMENT

ITEM NO.
31400-111



LASER CYSTOSCOPY SHEATH — 23 FR. Ø

- 2 STOPCOCKS — CONTINUOUS FLOW
- FOR USE WITH LASER WORKING MACHINE ELEMENT (BOTH Ø FIBERS)
- MADE IN GERMANY

ITEM NO.
31400-150





LASER CYSTOSCOPY



MADE IN THE USA

LASER CYSTOSCOPY TELESCOPE BRIDGE — 23 FR. Ø

- 1— 8 MM Ø INSTRUMENT CHANNEL
- FOR USE WITH 4 MM Ø SCOPES
- MADE IN GERMANY

ITEM NO. **31400-151**



LASER CYSTOSCOPY VISUAL OBTURATOR — 23 FR. Ø

- FOR USE WITH 4 MM Ø SCOPES
- FOR USE WITH 31400-150/31400-151

ITEM NO. **31400-152**



LASER CYSTOSCOPY STANDARD OBTURATOR — 23 FR. Ø

FOR USE WITH 31400-150/31400-151

ITEM NO. **31400-153**



LASER CYSTOSCOPY PUNCH FORCEPS — 24 FR. Ø

- FOR TISSUE REMOVED AFTER LASER TREATMENT
 - FOR USE WITH 4 MM Ø SCOPES
 - MADE IN GERMANY
- * FOR USE WITH SHEATH SYSTEM LIST NO. 31400-91 (PAGE 10)

ITEM NO. **31400-154**



TO ORDER CALL: (224) 353-6446



ENDO UROLOGY ACCESSORIES



MADE IN THE USA

ELLIK EVACUATOR

ITEM NO.	DESCRIPTION
31430-00A	ELLIK EVACUATOR COMPLETE - STANDARD CONE CONNECTOR
31430-00B	ELLIK EVACUATOR COMPLETE - QUICK LOCK CONE CONNECTOR



PICTURED COMPLETE SYSTEM

ELLIK EVACUATOR PARTS

ITEM NO.	DESCRIPTION
31430-01	GLASS BOWL ONLY—PICTURED ABOVE
31430-02	STANDARD TUBE WITH CONE (FIGURE 1)
31430-03	RUBBER BALL ONLY—PICTURED ABOVE
31430-04	QUICKLOCK TUBE WITH CONE (FIGURE 2)

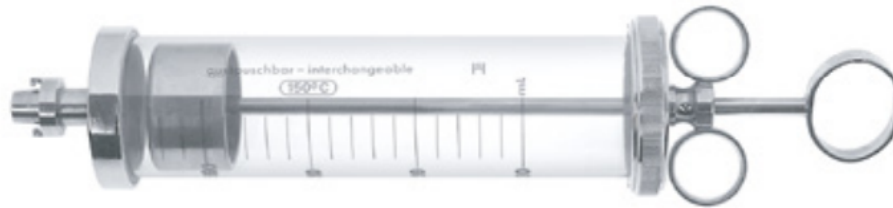

FIGURE 1



FIGURE 2

BLADDER SYRINGE— COMPLETE WITH LOCKING ADAPTER



ORDERING INFORMATION — GLASS BARREL SIZE — COMPLETE WITH LOCKING ADAPTERS

ADAPTER STYLE	50 mL ITEM No.	75 mL ITEM No.	100 mL ITEM No.	150 mL ITEM No.	200 mL ITEM No.
STANDARD CONNECTOR	31760-01	31760-02	31760-03	31760-04	31760-05
QUICK LOCK CONNECTOR	31760-11	31760-12	31760-13	31760-14	31760-15

BLADDER SYRINGE GLASS REPLACEMENT BARREL— NOT PICTURED

50 mL ITEM No.	75 mL ITEM No.	100 mL ITEM No.	150 mL ITEM No.	200 mL ITEM No.
31760-01	31760-02	31760-03	31760-04	31760-05
31760-11	31760-12	31760-13	31760-14	31760-15





ENDO UROLOGY ACCESSORIES



MADE IN THE USA

ADAPTOR — CONNECTORS — STOPCOCKS CATHETER ADAPTORS



ITEM No. 52000-02	ITEM No. 52000-03	ITEM No. 52000-06	ITEM No. 52000-10
SMOOTH INFUSION CATHETER ADAPTER W/ STRAIGHT FEMALE LUER LOCK	SERRATED INFUSION CATHETER ADAPTER W/ STRAIGHT FEMALE LUER LOCK	INFUSION CATHETER ADAPTER W/ BULBOUS TIP + FEMALE LUER LOCK CONNECTOR	SMOOTH INFUSION CATHETER ADAPTER W/ ANGLED FEMALE LUER LOCK

LUER LOCK TUBE CONNECTOR



ITEM No. 52000-16 (PICTURED)	ITEM No. 52000-18 (PICTURED)
MALE LUER LOCK WITH 6 MM Ø HOSE FITTING	FEMALE LUER LOCK WITH 6 MM Ø HOSE FITTING
ITEM No. 52000-17	ITEM No. 52000-19
MALE LUER LOCK WITH 8 MM Ø HOSE FITTING	FEMALE LUER LOCK WITH 8 MM Ø HOSE FITTING

STOPCOCK WITH LUER LOCK AND TUBE CONNECTOR

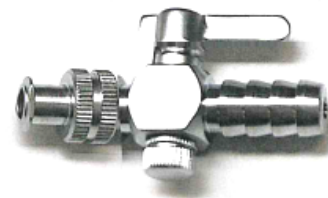

ITEM No. 52000-32	ITEM No. 52000-29
STOPCOCK WITH MALE LUER LOCK AND 6 MM Ø HOSE FITTING	STOPCOCK WITH FEMALE LUER LOCK AND 6 MM Ø HOSE FITTING
ITEM No. 52000-33 (PICTURED)	ITEM No. 52000-30 (PICTURED)
STOPCOCK WITH MALE LUER LOCK AND 8 MM Ø HOSE FITTING	STOPCOCK WITH FEMALE LUER LOCK AND 8 MM Ø HOSE FITTING





UROLOGICAL INSTRUMENTS



MADE IN THE USA

DILATING BOUGIES

DITTEL DILATING BOUGIES — STRAIGHT

DITTEL DILATING BOUGIES — CURVED

220 MM — 8 ¾"

350 MM — 13 ¾"

2⅔ MM Ø	8 CHARR./FR.	31380-08
3 MM Ø	9 CHARR./FR.	31380-09
3½ MM Ø	10 CHARR./FR.	31380-10
3¾ MM Ø	11 CHARR./FR.	31380-11
4 MM Ø	12 CHARR./FR.	31380-12
4½ MM Ø	13 CHARR./FR.	31380-13
4¾ MM Ø	14 CHARR./FR.	31380-14
5 MM Ø	15 CHARR./FR.	31380-15
5½ MM Ø	16 CHARR./FR.	31380-16
5¾ MM Ø	17 CHARR./FR.	31380-17
6 MM Ø	18 CHARR./FR.	31380-18
6½ MM Ø	19 CHARR./FR.	31380-19
6¾ MM Ø	20 CHARR./FR.	31380-20
7 MM Ø	21 CHARR./FR.	31380-21
7½ MM Ø	22 CHARR./FR.	31380-22
7¾ MM Ø	23 CHARR./FR.	31380-23
8 MM Ø	24 CHARR./FR.	31380-24
8½ MM Ø	25 CHARR./FR.	31380-25
8¾ MM Ø	26 CHARR./FR.	31380-26
9 MM Ø	27 CHARR./FR.	31380-27
9½ MM Ø	28 CHARR./FR.	31380-28
9¾ MM Ø	29 CHARR./FR.	31380-29
10 MM Ø	30 CHARR./FR.	31380-30
10½ MM Ø	32 CHARR./FR.	31380-32
11 MM Ø	33 CHARR./FR.	31380-33
11½ MM Ø	34 CHARR./FR.	31380-34
12 MM Ø	36 CHARR./FR.	31380-36

2⅔ MM Ø	8 FR.	31390-08
3 MM Ø	9 FR.	31390-09
3½ MM Ø	10 FR.	31390-10
3¾ MM Ø	11 FR.	31390-11
4 MM Ø	12 FR.	31390-12
4½ MM Ø	13 FR.	31390-13
4¾ MM Ø	14 FR.	31390-14
5 MM Ø	15 FR.	31390-15
5½ MM Ø	16 FR.	31390-16
5¾ MM Ø	17 FR.	31390-17
6 MM Ø	18 FR.	31390-18
6½ MM Ø	19 FR.	31390-19
6¾ MM Ø	20 FR.	31390-20
7 MM Ø	21 FR.	31390-21
7½ MM Ø	22 FR.	31390-22
7¾ MM Ø	23 FR.	31390-23
8 MM Ø	24 FR.	31390-24
8½ MM Ø	25 FR.	31390-25
8¾ MM Ø	26 FR.	31390-26
9 MM Ø	27 FR.	31390-27
9½ MM Ø	28 FR.	31390-28
9¾ MM Ø	29 FR.	31390-29
10 MM Ø	30 FR.	31390-30
10½ MM Ø	32 FR.	31390-32
11 MM Ø	33 FR.	31390-33
11½ MM Ø	34 FR.	31390-34
12 MM Ø	36 FR.	31390-36





UROLOGICAL INSTRUMENTS



MADE IN THE USA

DILATING BOUGIES



VAN BUREN

2½ MM Ø	8 FR.	31391-08
3½ MM Ø	10 FR.	31391-10
4 MM Ø	12 FR.	31391-12
4½ MM Ø	14 FR.	31391-14
5½ MM Ø	16 FR.	31391-16
6 MM Ø	18 FR.	31391-18
6½ MM Ø	20 FR.	31391-20
7½ MM Ø	22 FR.	31391-22
8 MM Ø	24 FR.	31391-24
8½ MM Ø	26 FR.	31391-26
9½ MM Ø	28 FR.	31391-28
10 MM Ø	30 FR.	31391-30
10½ MM Ø	32 FR.	31391-32
11½ MM Ø	34 FR.	31391-34
12 MM Ø	36 FR.	31391-36

VAN BUREN DILATING BOUGIES

31391-00



GUYON

3½ MM Ø	10 FR.	31393-10
3¾ MM Ø	11 FR.	31393-11
4 MM Ø	12 FR.	31393-12
4½ MM Ø	13 FR.	31393-13
4¾ MM Ø	14 FR.	31393-14
5 MM Ø	15 FR.	31393-15
5½ MM Ø	16 FR.	31393-16
5¾ MM Ø	17 FR.	31393-17
6 MM Ø	18 FR.	31393-18
6½ MM Ø	19 FR.	31393-19
6¾ MM Ø	20 FR.	31393-20
7 MM Ø	21 FR.	31393-21
7½ MM Ø	22 FR.	31393-22
7¾ MM Ø	23 FR.	31393-23
8 MM Ø	24 FR.	31393-24
8½ MM Ø	25 FR.	31393-25
8¾ MM Ø	26 FR.	31393-26
9 MM Ø	27 FR.	31393-27
9½ MM Ø	28 FR.	31393-28
9¾ MM Ø	29 FR.	31393-29
10 MM Ø	30 FR.	31393-30



FILIFORM DILATING BOUGIES

31101-03	3 FR.
31101-04	4 FR.
31101-05	5 FR.
31101-06	6 FR.

SOLD PKG (5)

GUYON DILATING BOUGIES

31393-00



TO ORDER CALL: (224) 353-6446



UROLOGICAL INSTRUMENTS



MADE IN THE USA

CATHETER GUIDE — INTRODUCING INSTRUMENTS

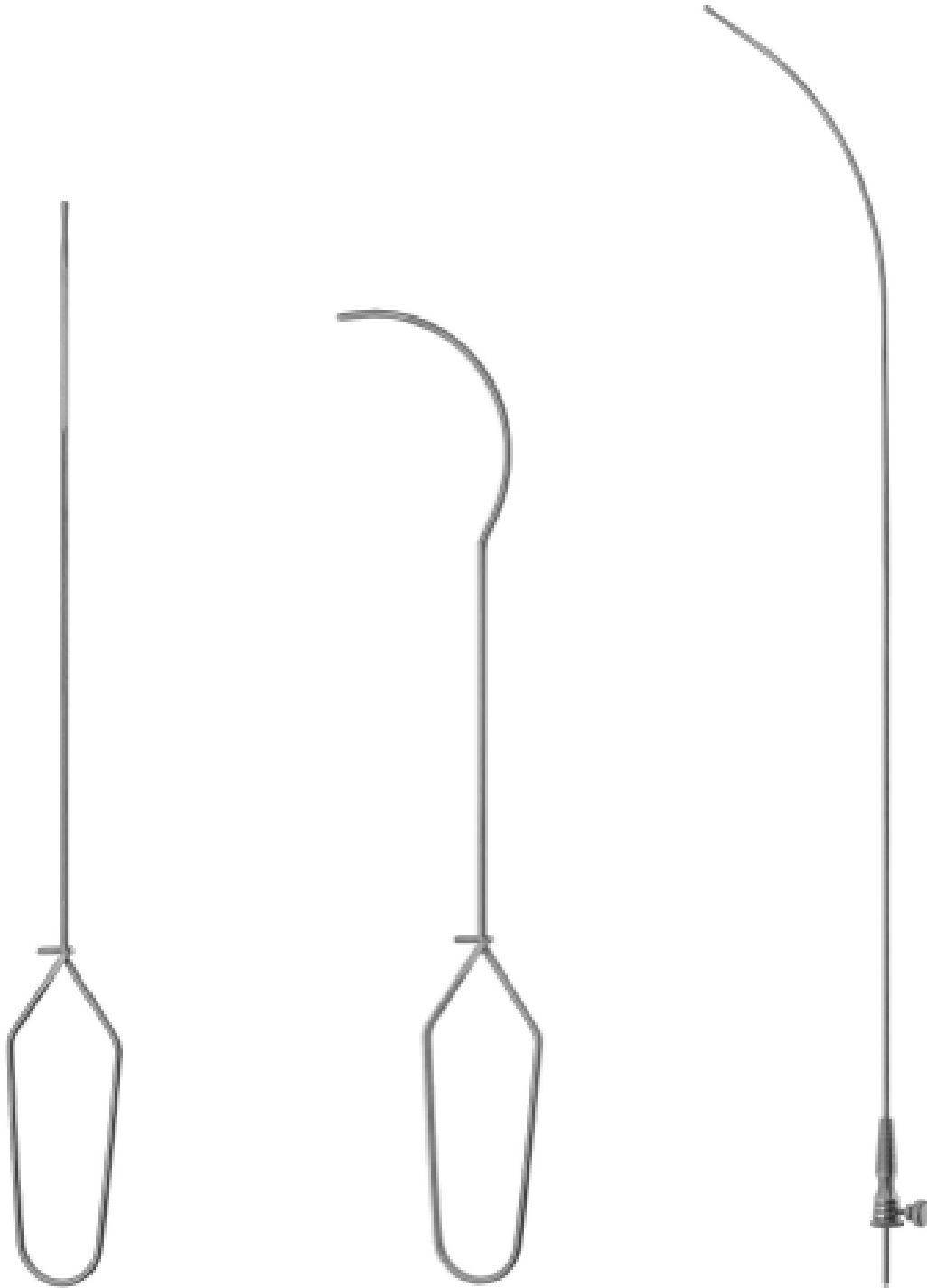

GUYON CATHETER
GUIDE

31070-39 39,0 CM, 15 ½"

GUYON CATHETER GUIDE

31070-35 35,0 CM, 13 ¾"

GUYON CATHETER GUIDE

31070-35 35,0 CM, 13 ¾"





UROLOGICAL INSTRUMENTS



MADE IN THE USA

GOODWIN STYLE DILATION SOUNDS

- STAINLESS STEEL FOR DILATING TIGHT URETRAS
- FLAT DISTAL END FOR CURVE DIRECTIONAL IDENTIFICATION
- AUTOCLAVABLE-MEDICAL GRADE STAINLESS STEEL



ITEM NO.	DESCRIPTION
31-4000	GOODWIN STYLE DILATION SOUNDS
SHAFT WITH CURVED TIP WITH FLAT DISTAL END FOR CURVE DIRECTIONAL IDENTIFICATION AND ERGONOMIC SURE GRIP ROUND HANDLE	
COMPLETE SET OF (10): 12 FR., 14 FR., 16 FR., 18 FR., 20 FR., 22 FR., 24 FR., 26 FR., 28 FR., 30 FR.	
AUTOCLAVABLE MEDICAL GRADE STAINLESS STEEL	

INDIVIDUAL ITEM ORDERING

ITEM NO.	DESCRIPTION
31-4012	12 FR. GOODWIN URETHRAL SOUND
31-4014	14 FR. GOODWIN URETHRAL SOUND
31-4016	16 FR. GOODWIN URETHRAL SOUND
31-4018	18 FR. GOODWIN URETHRAL SOUND
31-4020	20 FR. GOODWIN URETHRAL SOUND
31-4022	22 FR. GOODWIN URETHRAL SOUND
31-4024	24 FR. GOODWIN URETHRAL SOUND
31-4026	26 FR. GOODWIN URETHRAL SOUND
31-4028	28 FR. GOODWIN URETHRAL SOUND
31-4030	30 FR. GOODWIN URETHRAL SOUND



TO ORDER CALL: (224) 353-6446



UROLOGICAL INSTRUMENTS



MADE IN THE USA

MAGILL CATHETER INTRODUCING FORCEPS

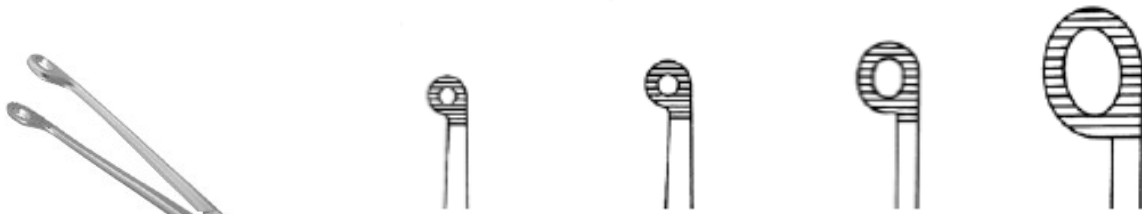

31001-15	31001-17	31001-20	31001-25
15CM, 6"	17CM, 6¾"	20CM, 8"	25CM, 9¾"

METAL CATHETERS FOR MEN

31112-08	8 FR.
31112-10	10 FR.
31112-12	12 FR.
31112-14	14 FR.
31112-16	16 FR.
31112-18	18 FR.
31112-20	20 FR.

METAL CATHETERS FOR WOMEN



31110-06	6 FR.
31110-07	7 FR.
31110-08	8 FR.
31110-09	9 FR.
31110-10	10 FR.
31110-11	11 FR.
31110-12	12 FR.
31110-13	13 FR.
31110-14	14 FR.
31110-16	16 FR.
31110-18	18 FR.
31110-20	20 FR.
31110-22	22 FR.
31110-24	24 FR.

WALTHER 5¼" 31220-00 (SET)



31220-12	12 FR.
31220-14	14 FR.
31220-16	16 FR.
31220-18	18 FR.
31220-20	20 FR.
31220-22	22 FR.
31220-24	24 FR.
31220-26	26 FR.
31220-28	28 FR.
31220-30	30 FR.
31220-32	32 FR.
31220-34	34 FR.
31220-36	36 FR.
31220-38	38 FR.

GUYON METAL CATHETERS
FOR WOMEN

GUYON METAL CATHETERS
FOR MEN





UROLOGICAL INSTRUMENTS



MADE IN THE USA

FOREIGN BODY FORCEPS

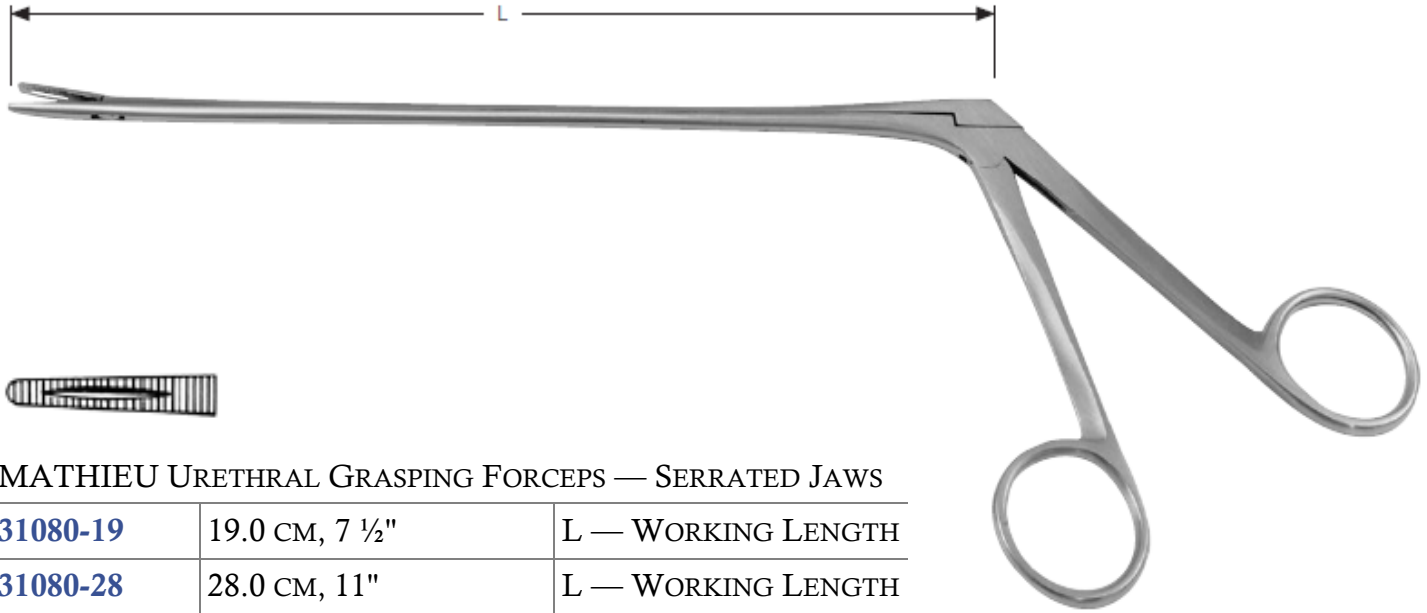

MATHIEU URETHRAL GRASPING FORCEPS — SERRATED JAWS

31080-19	19.0 CM, 7 ½"	L — WORKING LENGTH
31080-28	28.0 CM, 11"	L — WORKING LENGTH

MEATOTOME FORCEPS

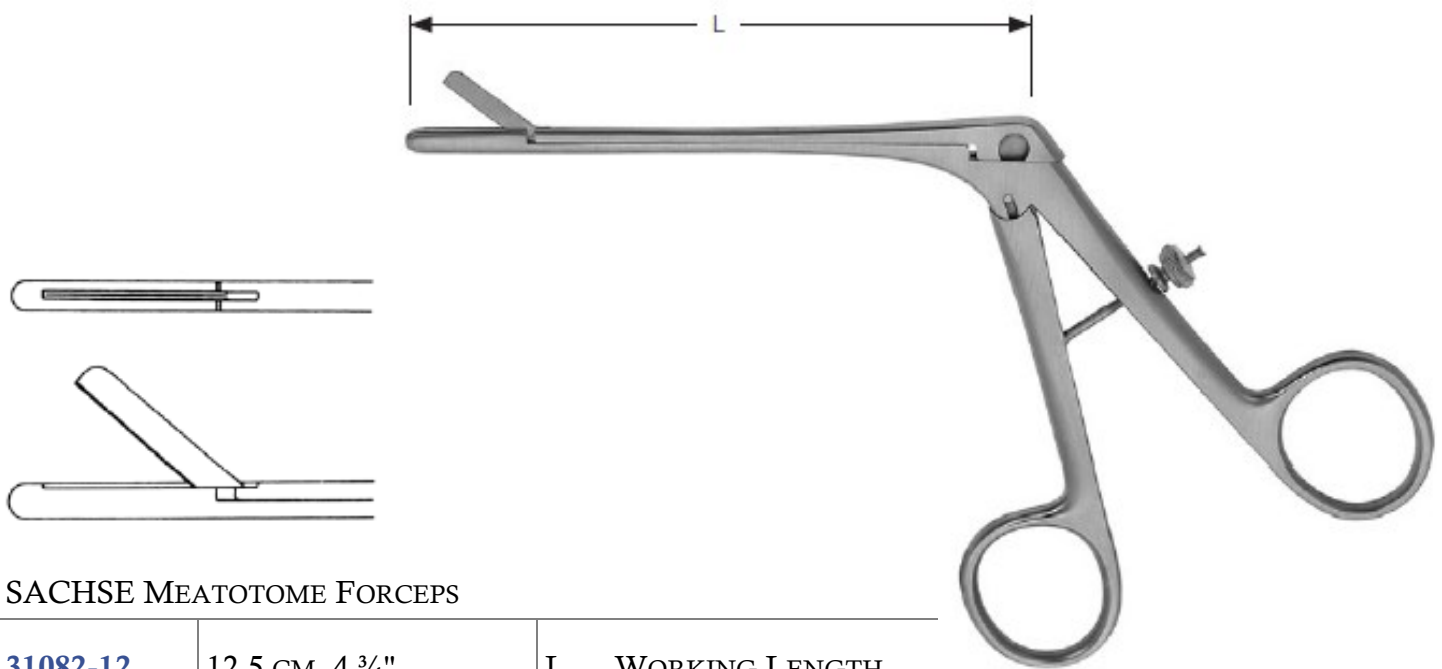

SACHSE MEATOTOME FORCEPS

31082-12	12.5 CM, 4 ¾"	L — WORKING LENGTH
-----------------	---------------	--------------------



TO ORDER CALL: (224) 353-6446



UROLOGICAL INSTRUMENTS



MADE IN THE USA

CAPSULE HOLDING FORCEPS



MILLIN AUTOMATIC TIP

31651-24 | 9½" (24 CM)

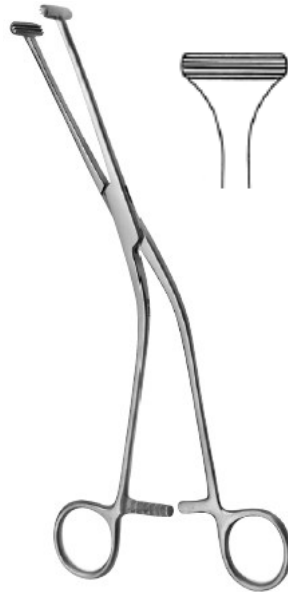

MILLIN TUBE TIP

31653-22 | 8¾" (22 CM)

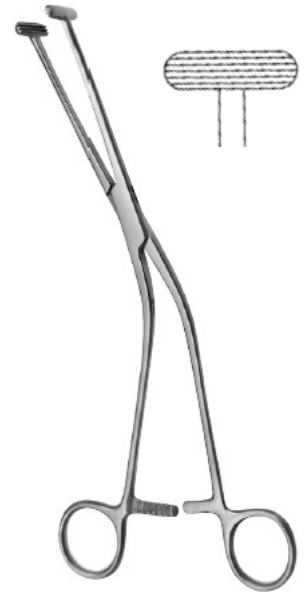

MILLIN FLAT TIP

31655-23 | 9½" (24 CM)



MILLIN 9x9 TEETH TIP

31657-23 | 9" (23 CM)

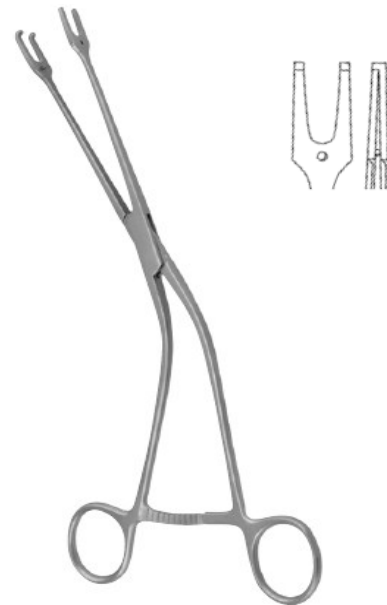

MILLIN FORK TIP

31659-24 | 9½" (24 CM)





UROLOGICAL INSTRUMENTS



MADE IN THE USA

BLADDER SPATULAS



LEGUEU BLADDER SPATULA

31621-27

10³/₄" (27 CM)

LEGUEU BLADDER NECK

31622-00

11" (28 CM)

MILLIN BLADDER SPATULA

31625-26

10¹/₄" (26 CM) 67 MM

PROSTATIC RETRACTORS



YOUNG—LATERAL

31623-01

8³/₄" (22 CM)

36 X 13 MM BLADE

YOUNG—ANTERIOR

31623-02

8³/₄" (22 CM)

68 X 38 MM BLADE

YOUNG—BULBOUS

31623-03

8³/₄" (22

23 X 25 MM BLADE

YOUNG — FORKED

31623-04

8³/₄" (22 CM)

36 X 38 MM BLADE



TO ORDER CALL: (224) 353-6446



UROLOGICAL INSTRUMENTS



MADE IN THE USA

BLADDER RETRACTORS



LEGUEU

31617-01
BLADDER RETRACTOR
FRAME

LEGUEU

31617-10
CENTRAL BLADE

LEGUEU

31617-11
LATERAL BLADE — SET

LEGUEU BLADDER RETRACTOR
31617-00 SET



THOMSON-WALKER BLADDER
RETRACTOR
31618-00 SET



MILLIN

31620-01
BLADDER RETRACTOR
FRAME

MILLIN

31620-02 | 110 x 45
MM

CENTRAL BLADE

MILLIN

31620-03 | 57 x 25 MM

31620-04 | 80 x 25 MM

LATERAL BLADE PAIR

MILLIN BLADDER RETRACTOR
31620-00 SET

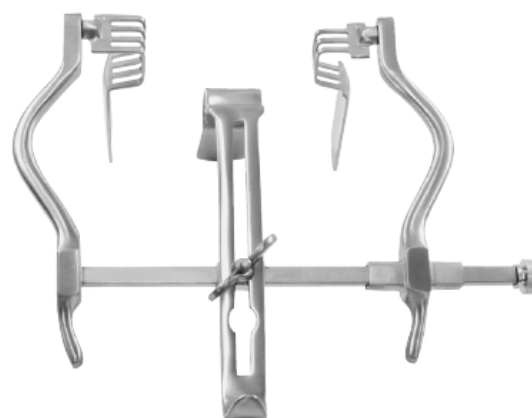

JUDD-MASSON BLADDER
RETRACTOR

31619-00 SET

LATERAL BLADE | 25 MM X 70 MM

CENTRAL BLADE | 24 MM X 84 MM





UROLOGICAL INSTRUMENTS



MADE IN THE USA

URETHRO DILATORS AND FORCEPS

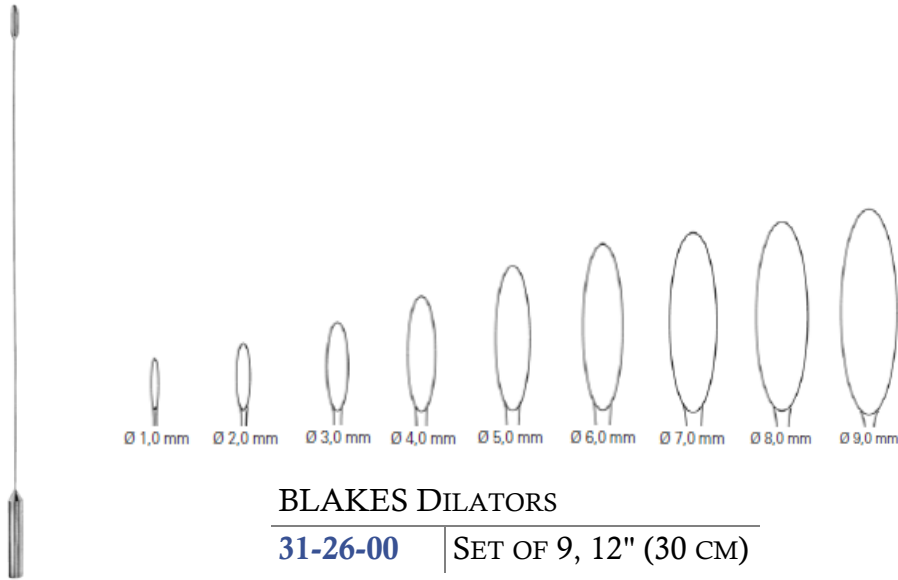

BLAKES DILATORS
31-26-00 | SET OF 9, 12" (30 CM)



LEGUEU KIDNEY SPATULA
31-18-22 | 100 MM X 44 MM

URETHRO FORCEPS



AUTOMATIC URETHRO FORCEPS
31-012-24 | 9 2/3" (24.0 CM) OVERALL LENGTH



MOORE SCOOP
31-30-28 | 11" (28 CM)



MAYO SCOOP
31-32-27 | 11" (28 CM)



TO ORDER CALL: (224) 353-6446



UROLOGICAL INSTRUMENTS



MADE IN THE USA

STONE FORCEPS AND PROBES



OCHSNER SPINAL PROBE
31-20-38 | 15" (38 CM)

MOYNIHAN PROBE
31-22-34 | 13½" (34 CM)

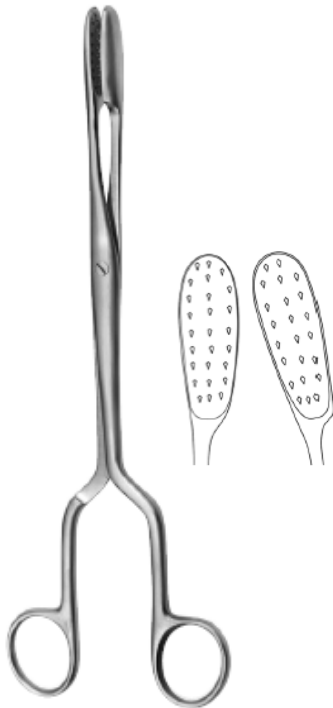

LEWKOWITZ STONE FORCEPS	9⅔" (24 CM) OVERALL LENGTH
31010-24	STRAIGHT
31011-24	CURVED

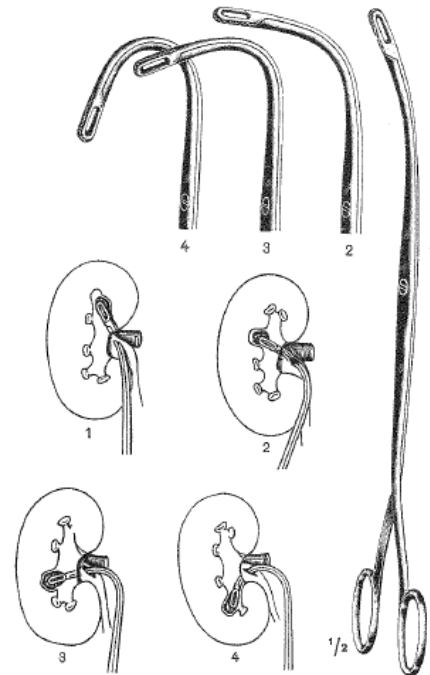

RANDALL STONE FORCEPS

FIG. 1 31-10-01 9" (23 CM)	FIG. 3 31-10-03 8¾" (22 CM)
FIG. 2 31-10-02 8¾" (22 CM)	FIG. 4 31-10-04 8¾" (22 CM)





UROLOGICAL INSTRUMENTS



MADE IN THE USA

VASECTOMY

QUALITY REUSABLE INSTRUMENT WITH GOLD HANDLES



ITEM NO. **31-50-01**

NO SCALPEL VASECTOMY FORCEPS 5" (12.5 CM)
WITH SHARP POINTED SMOOTH CURVED JAW

31-50-00

NO SCALPEL VASECTOMY FIXATOR CLAMP
FORCEPS — 1MM DIAMETER BLUNT RING TIPS,
5½" (14 CM)

31-50-05

NO SCALPEL VASECTOMY FIXATOR CLAMP
FORCEPS — 5MM DIAMETER BLUNT RING TIPS,
5½" (14 CM)



31-50-06

OPTIONAL STAINLESS STEEL STERILIZATION/
STORAGE CASE

FEATURING:

NO SCALPEL VASECTOMY IS A VASECTOMY
PROCEDURE USING A SHOW HEMOSTAT TO
PUNCTURE THE SCROTUM TO ACCESS THE
VAS DEFERENCE.

THE KEY BENEFIT IS THAT THERE IS NO
SUTURE REQUIRED TO CLOSE THE SKIN. DUE
TO THE SIMPLICITY OF THE PROCEDURE
AFFORDS ITSELF TO BE USED IN PUBLIC
PROGRAMS WORLDWIDE.



TO ORDER CALL: (224) 353-6446



UROLOGICAL INSTRUMENTS



MADE IN THE USA

CIRCUMCISION CLAMPS

“GOMCO” STYLE CIRCUMCISION CLAMPS

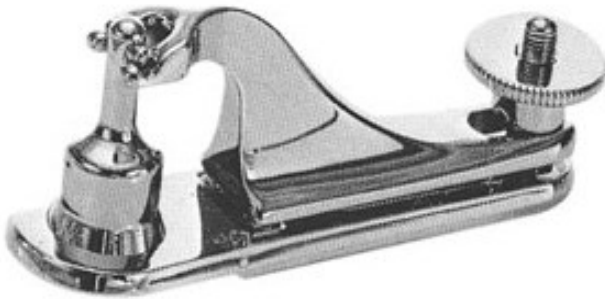

FEATURING A WIDE VARIETY OF SIZES FOR USE ON INFANTS, BOYS AND MEN OF ALL AGES/SIZES. BY CAREFUL ADJUSTMENT IT CAN BE USED TO ACHIEVE A VARIETY OF STYLES OF CIRCUMCISION.

*STOCKING ITEM

ITEM NO	DESCRIPTION		
31-55-00	“GOMCO” STYLE CIRCUMCISION CLAMPS, INFANT EXTRA SMALL	0.8 CM	(5/16”)
*31-55-01	“GOMCO” STYLE CIRCUMCISION CLAMPS, EXTRA SMALL	1.1 CM	(7/16”)
*31-55-03	“GOMCO” STYLE CIRCUMCISION CLAMPS, NEWBORN	1.3 CM	(1/2”)
31-55-03	“GOMCO” STYLE CIRCUMCISION CLAMPS, CHILD	1.45 CM	(9/16”)
*31-55-04	“GOMCO” STYLE CIRCUMCISION CLAMPS, CHILD	1.6 CM	(5/8”)
31-55-05	“GOMCO” STYLE CIRCUMCISION CLAMPS, YOUTH	2.1 CM	(13/16”)
31-05-06	“GOMCO” STYLE CIRCUMCISION CLAMPS, ADULT	2.6 CM	(1”)
31-55-07	“GOMCO” STYLE CIRCUMCISION CLAMPS, ADULT	3.2 CM	(1¼”)





UROLOGICAL INSTRUMENTS



MADE IN THE USA

TURNER WARWICK PEDIATRIC/PERINEAL RETRACTOR

FOR MINIMALLY INVASIVE URETHROPLASTY PROCEDURES AND FEMALE PELVIC RECONSTRUCTION

19261-01E

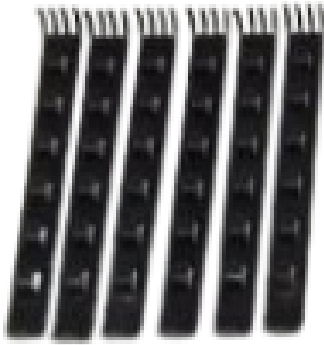

19261-02E

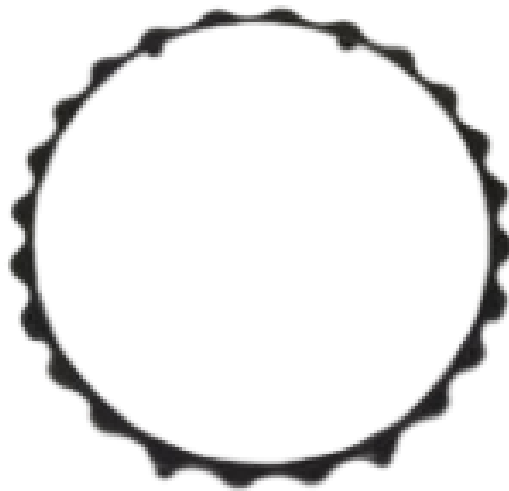

19261-04E



19263-01E

TURNER WARWICK PEDIATRIC/ PERINEAL RETRACTOR — COMPLETE SET

19261-00 INCLUDING THE FOLLOWING (ITEMS CAN BE PURCHASED SEPARATELY)

TURNER WARWICK RING

19261-01E	OVAL 7" x 5" (18 x 12.7 CM) EBONIZED BLACK	QTY. 1
------------------	---	-----------

TURNER WARWICK BLADE

19261-03E	6" L x 1 1/8" W x 1 1/8" H (15 x 3 x 3 CM) EBONIZED BLACK	QTY. 2
------------------	---	-----------

TURNER WARWICK RAKE BLADE — 4 PRONGS

19261-02E	5" L x 4 1/4" W x 1/2" H (12.5 x 1.7 x 1.2 CM) EBONIZED BLACK	QTY. 6
------------------	---	-----------

TURNER WARWICK BLADE MALLEABLE

19261-04E	7 1/2" L x 2 3/8" W x 1 1/8" H (15 x 6 x 3 CM) EBONIZED BLACK	QTY. 1
------------------	---	-----------

AUTOCLAVABLE MEDICAL GRADE STAINLESS STEEL



TO ORDER CALL: (224) 353-6446



UROLOGICAL INSTRUMENTS



MADE IN THE USA

TURNER WARWICK ADULT RETRACTOR

IDEAL FOR USE IN URETHROPLASTY PROCEDURES AND FEMALE RECONSTRUCTION

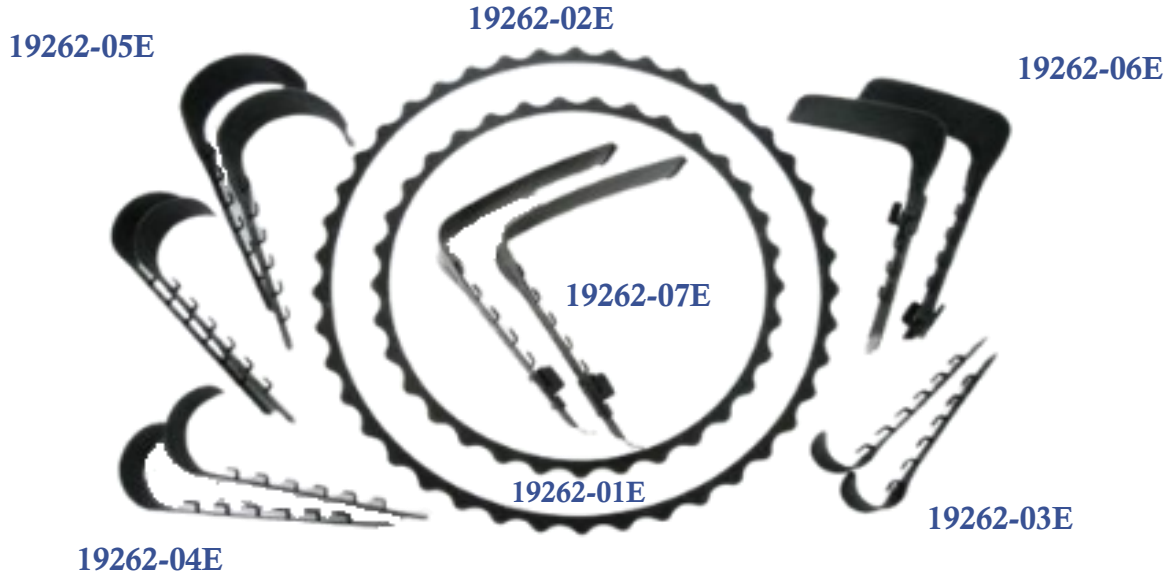

TURNER WARWICK ADULT RETRACTOR — COMPLETE SET

19262-00 | INCLUDING THE FOLLOWING (ITEMS CAN BE PURCHASED SEPARATELY)

TURNER WARWICK SMALL RING

19262-01E	ROUND 9" (23 CM) EBONIZED BLACK	QTY. 1
------------------	---------------------------------	-----------

TURNER WARWICK LARGE RING

19262-02E	ROUND 11 $\frac{7}{8}$ " (30 CM) EBONIZED BLACK	QTY. 1
------------------	---	-----------

TURNER WARWICK BLADE

19262-03E	6" L x 1 $\frac{1}{8}$ " W x 1 $\frac{1}{8}$ " H (15 x 3 x 3 CM) EBONIZED BLACK	QTY. 2
------------------	---	-----------

TURNER WARWICK BLADE

19262-04E	6 $\frac{1}{2}$ " L x 1 $\frac{7}{8}$ " W x 1 $\frac{1}{2}$ " H (16.5 x 4.7 x 4 CM) EBONIZED BLACK	QTY. 4
------------------	--	-----------

TURNER WARWICK BLADE

19262-05E	7 $\frac{3}{4}$ " L x 2 $\frac{3}{4}$ " W x 2 $\frac{3}{8}$ " H (18.5 x 7 x 6 CM) EBONIZED BLACK	QTY. 2
------------------	--	-----------

TURNER WARWICK BLADE WITH SLIDING LOCK

19262-06E	7 $\frac{1}{2}$ " L x 3 $\frac{1}{2}$ " W x 2 $\frac{1}{2}$ " H (19 x 9 x 6.5 CM) EBONIZED BLACK	QTY. 2
------------------	--	-----------

TURNER WARWICK BLADE WITH SLIDING LOCK

19262-07E	7 $\frac{1}{2}$ " L x 4 $\frac{3}{4}$ " W x 2 $\frac{1}{2}$ " H (19 x 12 x 6.5 CM) EBONIZED BLACK	QTY. 2
------------------	---	-----------

OPTIONAL—NOT INCLUDED IN SET

TURNER WARWICK BLADE — MALLEABLE

19262-08E	7 $\frac{1}{2}$ " L x 3 $\frac{1}{2}$ " W x 2 $\frac{1}{2}$ " H (19 x 9 x 6.5 CM) WITH SLIDING LOCK
------------------	---

TURNER WARWICK BLADE—MALLEABLE

19262-09E	7 $\frac{1}{2}$ " L x 4 $\frac{3}{4}$ " W x 2 $\frac{1}{2}$ " H (19 x 12 x 6.5 CM) WITH SLIDING LOCK
------------------	--

AUTOCLAVABLE MEDICAL GRADE STAINLESS STEEL



WE DESIGN, MANUFACTURE & SELL THE TOOLS THE SURGEONS USE



UROLOGICAL INSTRUMENTS



MADE IN THE USA

DENNIS BROWN ADULT & PEDIATRIC RETRACTOR SYSTEM RETRACTOR SYSTEM FOR URETHROPLASTY AND FEMALE PELVIC RECONSTRUCTION PROCEDURE

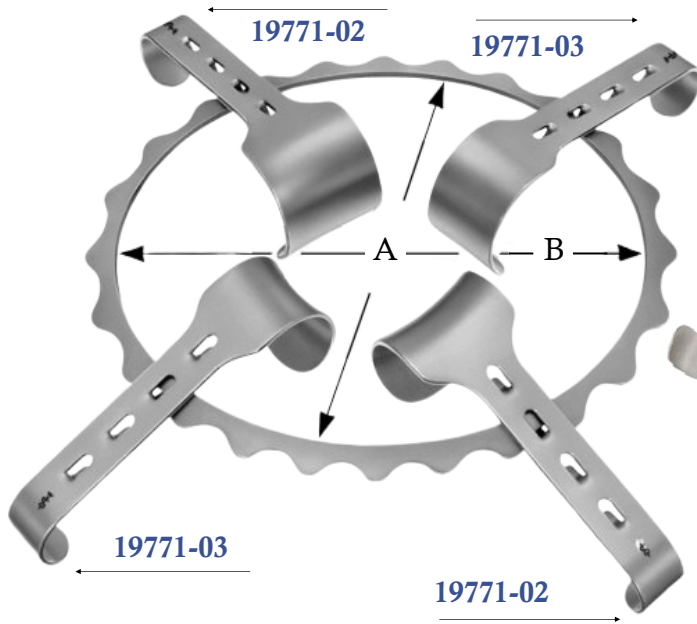

DENNIS BROWN OPTIONAL BLADE

19771-04



DENNIS BROWN RETRACTOR SYSTEM

19771-00	PEDIATRIC FRAME CONSISTING OF: (1)A (2)C (2)D
19772-00	ADULT FRAME CONSISTING OF: (1)B (2)C (2)D

DENNIS BROWN PEDIATRIC FRAME

(A) 19771-01	OVAL (A) 6¼" X (B) 7½" (16 X 19 CM)	QTY. 1
---------------------	-------------------------------------	-----------

DENNIS BROWN ADULT FRAME

(B) 19772-01	OVAL (A) 7" X 16" X (B) 8¾" (18 X 25.5 CM)	QTY. 1
---------------------	--	-----------

DENNIS BROWN BLADE

(C) 19771-02	1½" W X 1¼" H (4 X 3 CM)	QTY. 2
---------------------	--------------------------	-----------

DENNIS BROWN BLADE

(D) 19771-03	1½" W X 1½" H (4 X 4 CM)	QTY. 2
---------------------	--------------------------	-----------

DENNIS BROWN OPTIONAL BLADE

(E) 19771-02	(E) 1" W X 1" H (2.5 X 2.5 CM) FLAT MALLEABLE BLADE TIP	QTY. 2
---------------------	--	--------

NON-REFLECTIVE MEDICAL GRADE STAINLESS STEEL



TO ORDER CALL: (224) 353-6446



UROLOGICAL INSTRUMENTS



MADE IN THE USA

MEATUS AND INCONTINENCE CLAMPS



31-51-00



31-51-02



31-51-01



31-51-03



31-52-02

31-52-03

31-52-04



31-52-05



31-51-04

ITEM NO.	DESCRIPTION	ITEM NO.	DESCRIPTION
31-51-00	DAVIS MEATUS CLAMP	31-52-02	CUNNINGHAM INCONTINENCE CLAMP, JUVENILE
31-51-01	WHITVER MEATUS CLAMP	31-52-03	CUNNINGHAM INCONTINENCE CLAMP, REGULAR
31-51-02	BLACK MEATUS CLAMP	31-52-04	CUNNINGHAM INCONTINENCE CLAMP, LARGE
31-51-03	HYAMS MEATUS CLAMP	31-52-05	BAUMRUCKER INCONTINENCE CLAMP
31-51-04	ZIPSTER MEATUS CLAMP		





UROLOGICAL INSTRUMENTS



MADE IN THE USA

CAMPBELL SUPRAPUBIC TROCAR AND CANNULA



APPLICATION FOR TROCAR CYSTOSCOPY THAT IS INDICATED IN PATIENTS WITH CHRONIC URINARY RETENTION IN WHICH PROLONGED PERIOD OF URINARY DRAINAGE IS NECESSARY AND DESIRABLE.



CAMPBELL SUPRAPUBIC TROCAR AND CANNULA

31-04-40

CANNULA GRADUATED IN CENTIMETER, GROOVED TO ACCOMMODATE 20 FR. FOLEY

FOLEY CATHETER TIP PUNCH



REUSABLE-LITE ALUMINUM CONSTRUCTION PUNCH FOR CUTTING 3MM Ø ROUND HOLE ON DISTAL END OF FOLEY UTERINE CATHETER.

FOLEY CATHETER TIP PUNCH

SM31-0919GL

REUSABLE FOLEY STYLE CATHETER TIP PUNCH, AUTOCLAVABLE MEDICAL GRADE STAINLESS STEEL AND





UROLOGICAL INSTRUMENTS — PROSTATECTOMY



MADE IN THE USA

ROTH URETHRAL SUTURE GUIDES

Roth Urethral Suture Guides greatly simplify urethral anastomosis.

U.S. Patent No. 4,911,164

Simply inserting Greenwald's suture guide (in the 28FR size) like a sound will usually force enough of the urethra into the cavity to allow placement of sutures, making the task of reanastomosing urethra and bladder neck much easier after radical prostatectomy.

These guides (available as sets of one each, 24FR and 28FR)* are also extremely useful for internal male urinary diversion and for urethral repair following traumatic injury.

100% stainless steel construction, mirror finished. Greenwald's suture guides provide precision spaced 90° grooved guides for suture needles.

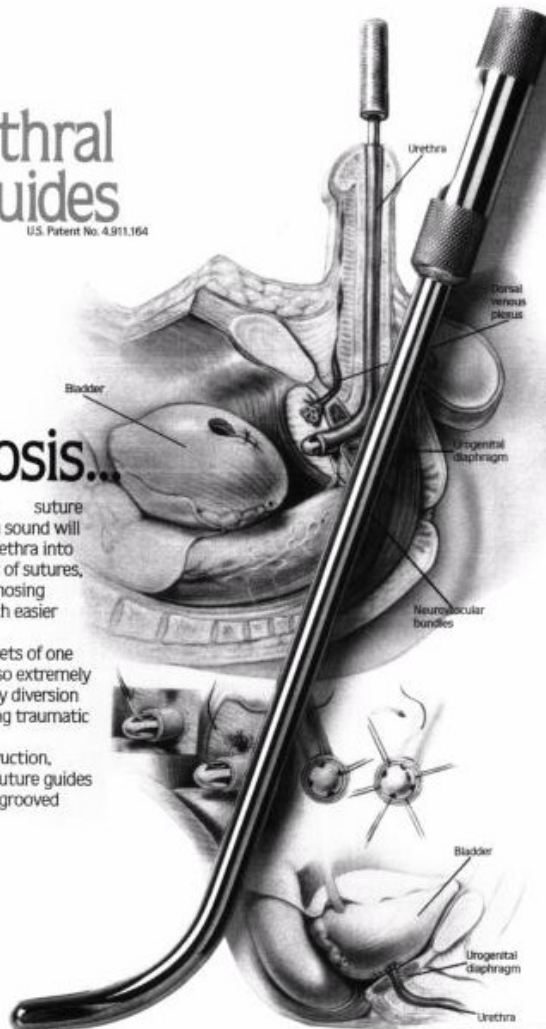

ROTH URETHRAL SUTURE GUIDES

31-0124	24 FR.
31-0128	28 FR.

AUTOCLAVABLE MEDICAL GRADE STAINLESS STEEL

FEATURES: THREE RETRACTABLE GRIPPING RODS ENDS. THREE SETS OF PAIRED SUTURE GUIDE GLOVES ARRANGED AT 120 DEGREE INTERVALS. PRECISION MACHINED, MIRROR-FINISH STAINLESS STEEL COMPONENTS.



ROTH NONE SLIP TIP URETHRAL SUTURE GUIDES

31-1524	24 FR.
31-1528	28 FR.



WE DESIGN, MANUFACTURE & SELL THE TOOLS THE SURGEONS USE



UROLOGICAL INSTRUMENTS — PROSTATECTOMY



MADE IN THE USA

LOWSLEY PROSTATIC TRACTOR

FOR APPLYING GENTLE TRACTION TO THE PROSTATE WITHOUT TRAUMA TO THE GLAND. FOR APPLYING GENTLE TRACTION TO THE PROSTATE WITHOUT TRAUMA TO THE GLAND.



ITEM NO.	DESCRIPTION		
31-2225	LOWSLEY PROSTATIC TRACTOR —	20 FR.	11" OVERALL LENGTH
31-2235	LOWSLEY PROSTATIC TRACTOR —	20 FR.	13" OVERALL LENGTH
31-2240	LOWSLEY PROSTATIC TRACTOR —	20 FR.	13" OVERALL LENGTH



ITEM NO.	DESCRIPTION	
31-2225	YOUNG PROSTATIC TRACTOR — STRAIGHT	13½" OVERALL LENGTH



TO ORDER CALL: (224) 353-6446



UROLOGICAL INSTRUMENTS — PROSTATECTOMY



MADE IN THE USA

DURRANI AND STAMEY

COMPLIMENTARY INSTRUCTIONS TO HELP MANAGE THE DORSAL VEIN COMPLEX DURING RADICAL PROSTATECTOMY:

1

STAMEY DORSAL VEIN APICAL RETRACTOR

HANDLE FLANGE DESIGN PROVIDES FOR SECURE CONTROL AND CEPHALAD RETRACTION. THE RETRACTOR BLADES PROVIDE A WIDE SPACE ON BOTH SIDES OF THE

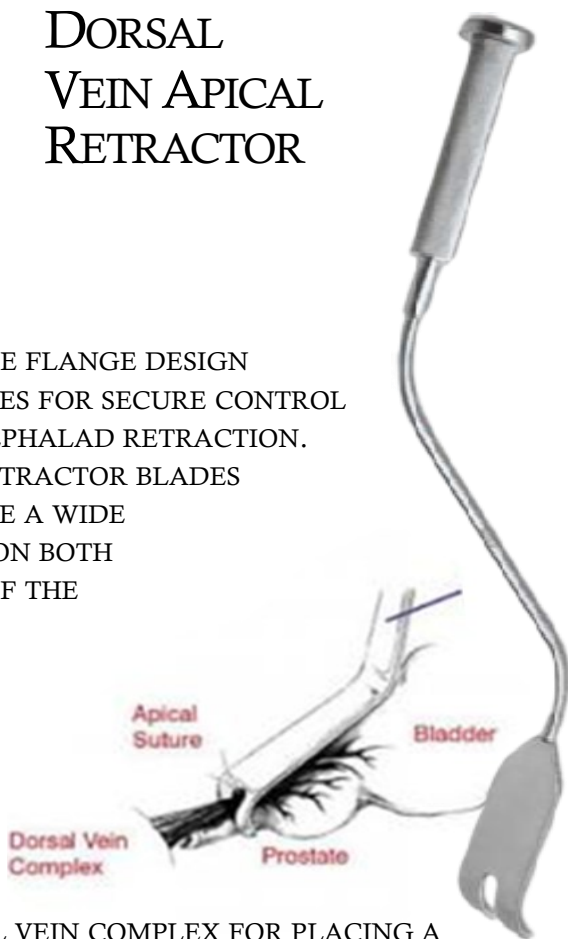

DORSAL VEIN COMPLEX FOR PLACING A CONTROLLING SUTURE. (DETAILED IN THE AVAILABLE ABSTRACT.)

2

DURRANI D.V COMPLEX LIGATION NEEDLE

TIP DESIGN AND LENGTH PROVIDE FOR RELATIVELY SIMPLE AND PREDICTABLE PASSAGE OF LIGATURE BETWEEN DORSAL VEIN COMPLEX AND URETHRA. FLAT HANDLE DESIGN AIDS IN NEEDLE ORIENTATION CONTROL AND THE APPLICATION OF EVEN HAND PRESSURE.

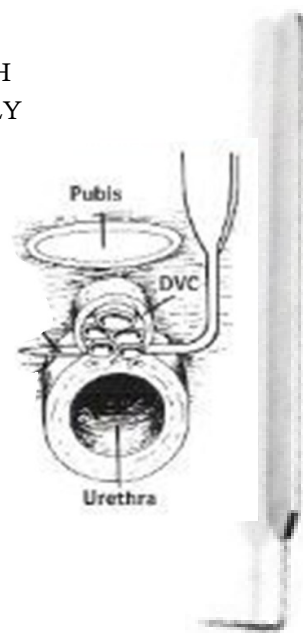

AUTOCLAVABLE MEDICAL GRADE STAINLESS STEEL

	ITEM No.	DESCRIPTION
1	31-2225	STAMEY DORSAL VEIN APICAL RETRACTOR
2	31-2235	DURRANI DORSAL VEIN COMPLEX LIGATION NEEDLE





UROLOGICAL INSTRUMENTS — PROSTATECTOMY



MADE IN THE USA

RETRACTORS FOR RETROPUBIC PROSTATECTOMY

THESE RETRACTORS SHOWN BELOW PROVIDE OPTIMAL EXPOSURE OF THE DORSAL VEIN COMPLEX AND POSTERIOR RETRACTION OF THE BLADDER.



YU-HOLTGREWE PROSTATIC RETRACTOR

31-0040 | MALLEABLE PROSTATIC RETRACTOR



YU-HOLTGREWE PROSTATIC RETRACTOR

31-0040 | MALLEABLE PROSTATIC RETRACTOR
2½" x 7" W/ SIMPSON HANDLE



YU-HOLTGREWE PROSTATIC RETRACTOR

31-0040 | MALLEABLE PROSTATIC RETRACTOR
2½" x 7" W/ SIMPSON HANDLE



YU-HOLTGREWE PROSTATIC RETRACTOR

31-0040 | MALLEABLE PROSTATIC
RETRACTOR 2½" x 7" W/



TO ORDER CALL: (224) 353-6446



UROLOGICAL ELECTROSURGERY



MADE IN THE USA

FLEXIBLE ELECTRODES FOR RIGID CYSTOSCOPES

FEATURING: PRECISION MACHINED NICKEL/ SILVER ELECTRODE TIPS. COLOR CODED TEFLON SHAFT INSULATION.

REUSABLE — FULLY AUTOCLAVABLE



SHAFT SIZE/COLOR		POINTED TIP	CONICAL TIP	BUGBEE TIP	DOMED TIP	STRAIGHT TIP	BALL TIP
3 FR.	BLACK			31-5721-3	31-5722-3		
4 FR.	RED	31-5720-4	31-5726-4	31-5721-4	31-5722-4	31-5727-4	31-5723-4
5 FR.	GRAY	31-5720-5	31-5726-5	31-5721-5	31-5722-5	31-5727-5	31-5723-5
6 FR.	GREEN	31-5720-6	31-5726-6	31-5721-6	31-5722-6	31-5727-6	31-5723-6
7 FR.	ORANGE	31-5720-7	31-5726-7	31-5721-7	31-5722-7	31-5727-7	31-5723-7
8 FR.	BLUE	31-5720-8	31-5726-8	31-5721-8	31-5722-8	31-5727-8	31-5723-8
5 FR.	GRAY			31-57120-5			
6FR.	GREEN			31-57120-6			
8 FR.	BLUE			31-57120-8			
5 FR.	GRAY			31-57240-5			
6FR.	GREEN			31-57240-6			
8 FR.	BLUE			31-57240-8			

SPECIAL TIPS



	SHAFT SIZE/ COLOR		ITEM NO.
(A) LOOP TIP	6 FR.	GREEN	31-5724-6
(B) FLAT TIP	5 FR.	GRAY	31-5728-5
(C) BUNGE MEATOME	6 FR.	GREEN	31-5729-6



ADAPTER

31-5700

ADAPTER FOR CYSTOSCOPIC ELECTRODES





UROLOGICAL ELECTROSURGERY



MADE IN THE USA

CONTROL TIP ® ELECTRODES FOR RIGID CYSTOSCOPES

FEATURING: ADJUSTABLE CURVE AT ELECTRODE TIP AND 360° ROTATION PROVIDE PRECISE TIP CONTROL PRECISION MACHINED NICKEL/ SILVER ELECTRODE TIPS AND COLOR CODED SHAFT INSULATION.

REUSABLE — FULLY AUTOCLAVABLE

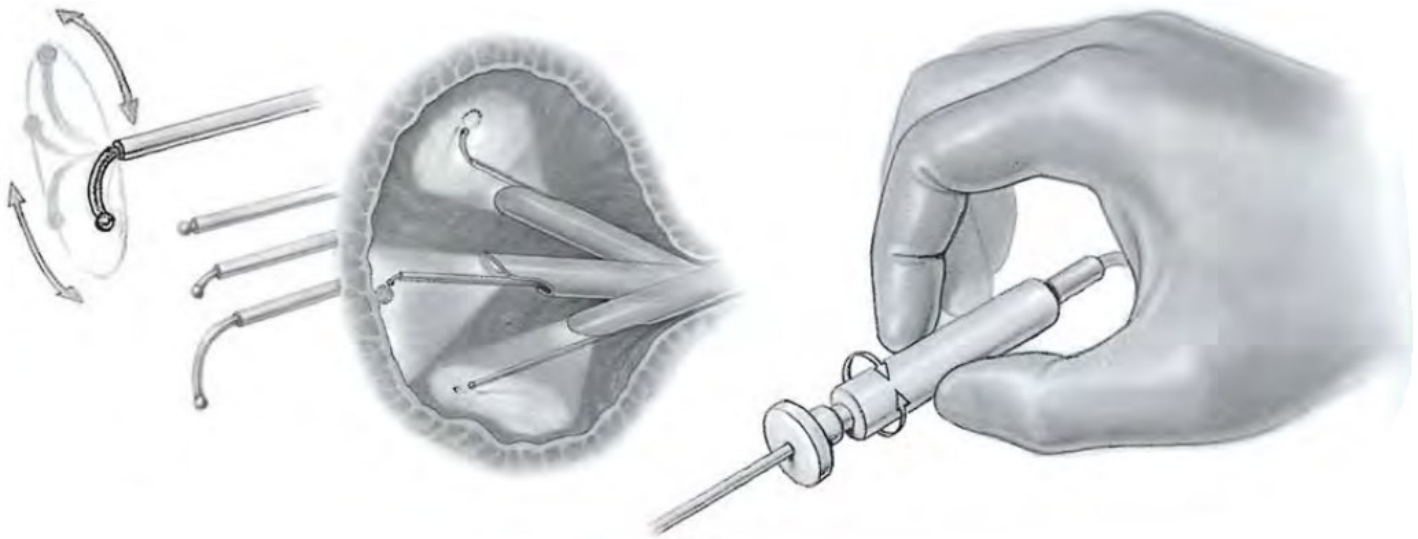

SHAFT SIZE/COLOR		POINTED TIP	CONICAL TIP	BUGBEE TIP	ANGULAR TIP	STRAIGHT TIP	BALL TIP
5 FR.	GRAY	31-5790-5	31-5796-5	31-5791-5	31-5798-5	31-5787-5	31-5793-5
6 FR.	GREEN	31-5790-6	31-5796-6	31-5791-6	31-5798-6	31-5797-6	31-5793-6
7 FR.	ORANGE	31-5790-7	31-5796-7	31-5791-7	31-5798-7	31-5797-7	31-5793-7

SUGGESTED MONOPOLAR RF CABLES

ITEM NO.	DESCRIPTION
5260	REUSABLE MONOPOLAR RF CABLE — PIN INSTRUMENT & MALE BANANA PLUG
5261	REUSABLE MONOPOLAR RF CABLE — PIN INSTRUMENT BOVIE PLUG



TO ORDER CALL: (224) 353-6446



UROLOGICAL ELECTROSURGERY



MADE IN THE USA

ELECTRODES FOR FLEXIBLE URETEROSCOPES AND FLEXIBLE CYSTOSCOPES

FEATURING: PRECISION MACHINED NICKEL/ SILVER ELECTRODE TIPS. COLOR CODED TEFLON SHAFT INSULATION.



SHAFT SIZE/COLOR		STD. LENGTH	BALL TIP	BUGBEE TIP	DOMED TIP	ANGULAR TIP
2 FR.	BLUE	120 CM		31-5783-2	31-5784-2	
3 FR.	BLACK	120 CM		31-5783-3	31-5784-3	31-5787-3
4 FR.	RED	90 CM	31-5781-4	31-5783-4	31-5784-4	31-5787-4
5 FR.	GRAY	60 CM	31-5781-5	31-5783-5	31-5784-5	31-5787-5

*SPECIAL MODE LENGTHS AVAILABLE — INQUIRY

CONTROL TIP[®] ELECTRODES FOR RIGID URETEROSCOPES

FEATURING: ADJUSTABLE CURVE AT ELECTRODE TIP AND 360° ROTATION PROVIDE PRECISE TIP CONTROL PRECISION MACHINED NICKEL/ SILVER ELECTRODE TIPS AND COLOR CODED SHAFT INSULATION.

REUSABLE — FULLY AUTOCLAVABLE

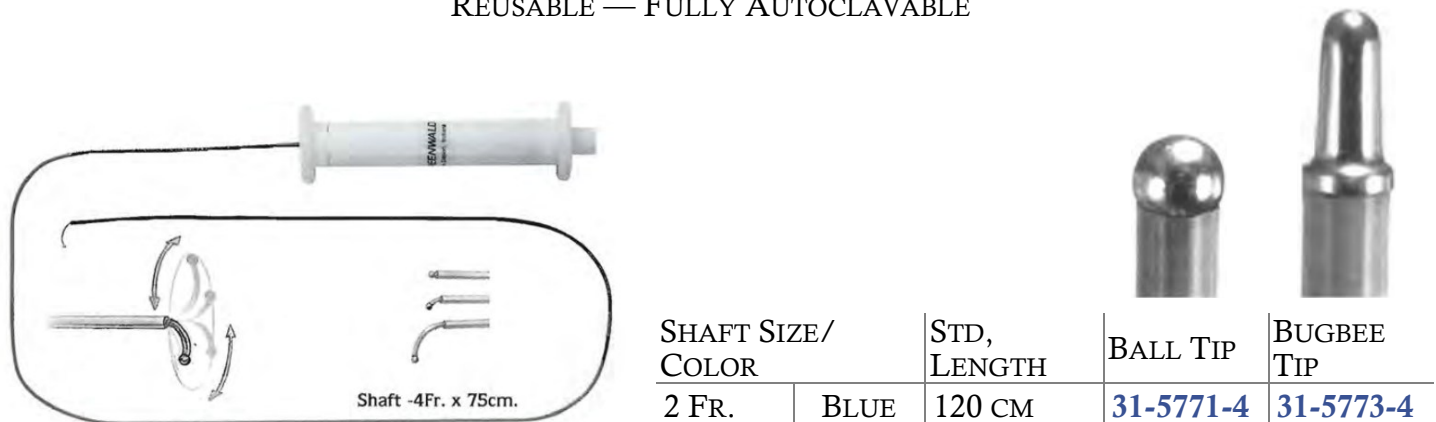

SHAFT SIZE/ COLOR		STD, LENGTH	BALL TIP	BUGBEE TIP
2 FR.	BLUE	120 CM	31-5771-4	31-5773-4





UROLOGICAL ELECTROSURGERY



MADE IN THE USA

RECOMMENDED REUSABLE MONOPOLAR ELECTRODES

FOR FULL LISTING OF ELECTRODES SEE OUR DATA SHEET "ELMED REUSABLE MONOPOLAR SURGICAL ELECTRODES"

ELMED REUSABLE PIN-POINT™ MICRO TIP ELECTRODES

SPECIAL MICRO-GROUND & POLISHED TIP FOR PIN-POINT CUTTING AND MINIMUM ESCHAR BUILDUP
THE ELECTRODE SHAFTS ARE KYNAR-COATED, MAKING THEM REUSABLE & AUTOCLAVABLE — 3MM (3/32") Ø SHAFT



5901-01 STRAIGHT TIP; 1 CM NEEDLE SHAFT, 2.5 CM (1") OVERALL WORKING LENGTH



5902-01 45° TIP; 2 CM NEEDLE SHAFT, 3.5 CM (1.5") OVERALL WORKING LENGTH



5901-02 STRAIGHT TIP; 2 CM NEEDLE SHAFT, 3.5 CM (1.5") OVERALL WORKING LENGTH



5902-02 45° TIP; 3 CM NEEDLE SHAFT, 4.5 CM (2") OVERALL WORKING LENGTH



5901-03 STRAIGHT TIP; 4 CM NEEDLE SHAFT, 4.5 CM (2") OVERALL WORKING LENGTH



5903-01 STRAIGHT TIP; 45° 2 CM NEEDLE SHAFT, 3.5 CM (1.5") OVERALL WORKING LENGTH



5901-04 STRAIGHT TIP; 1 CM NEEDLE SHAFT, 5.5 CM (2.5") OVERALL WORKING LENGTH



5903-02 STRAIGHT TIP; 90° 2 CM NEEDLE SHAFT, 3.5 CM (1.5") OVERALL WORKING LENGTH



5901-05 STRAIGHT TIP; CURVED 1 CM NEEDLE SHAFT, 3 CM (1.25") OVERALL WORKING LENGTH



5903-03 STRAIGHT TIP; CURVED 3 CM NEEDLE SHAFT, 5 CM (2.5") OVERALL





UROLOGICAL ELECTROSURGERY



MADE IN THE USA

REUSABLE KYNAR-COATED STAINLESS STEEL MONOPOLAR ELECTRODES

FOR CUTTING AND COAGULATION, 3MM (3/32") DIAMETER SHAFT—55 MM LENGTH.



5706-05 CUTTING NEEDLE ELECTRODE



5702-05 MICRO NEEDLE ELECTRODE, 45°



5721-05 4MM Ø COAGULATING BALL

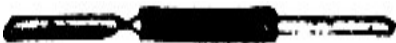

5707-05 CUTTING/ COAGULATION



5708-05 3MM Ø WIRE LOOP ELECTRODE



5701-05 MICRO NEEDLE ELECTRODE



5720-05 2MM Ø COAGULATING BALL ELECTRODE



5709-05 5MM Ø WIRE LOOP ELECTRODE

REUSABLE MONOPOLAR HANDLES FOR FOOT & HAND SWITCHING

ITEM No.	DESCRIPTION
5750	HAND-SWITCHING DUAL BUTTON CUTTING/ COAGULATION WITH ATTACHED CABLE
5014	FOOT-SWITCHING HANDLE FOR 3 MM (3/32") Ø SHAFT ELECTRODES

RECOMMENDED REUSABLE RF CABLES FOR FOOT & HAND SWITCHING

ITEM No.	DESCRIPTION
5021	REUSABLE MONOPOLAR RF CABLE — FOR UNIT WITH 4 MM MALE BANANA PLUG
5009	REUSABLE MONOPOLAR RF CABLE — FOR UNIT WITH BOVIE PLUG





UROLOGICAL ELECTROSURGERY



MADE IN THE USA

ELMED BIPOLAR SURGICAL CUT-COAG SCISSORS

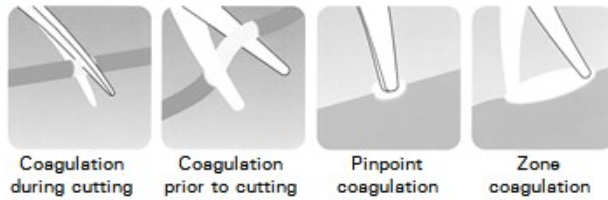

TIP STYLE A
STANDARD



1/2 OUTSIDE BLADE, HEAVY DUTY
SYNTHETIC BLUE INSULATION



NEW MICRO
ROUND TIP
BLADES



BLADE AND BODY WITH
HEAVY DUTY SYNTHETIC
BLUE INSULATION

TIP STYLE B
SLIM BLADE



3/4 OUTSIDE BLADE, HEAVY DUTY SYNTHETIC BLUE
INSULATION

ITEM NO.	DESCRIPTION
5950-03	CURVED MICRO: 13CM (5.25")
5950-04	CURVED MICRO: 14CM (5.5")

ITEM NO.	DESCRIPTION
5960-18	CURVED METZENBAUM: 18CM (7")
5960-21	CURVED METZENBAUM: 21CM (8.25")
5960-23	CURVED METZENBAUM: 23CM (9")
5960-28	CURVED METZENBAUM: 28CM (11")



TO ORDER CALL: (224) 353-6446



CYSTOSCOPY VIDEO SYSTEM

IDEAL FOR OFFICE AND SURGICAL SUITES WHERE SPACE AND BUDGET ARE LIMITED.



51800-01 ELMED MINI ENDOSCOPIC VIDEO CART SYSTEM

FEATURES OF THE SYSTEM

- ELMED COMBO DIGITAL CAMERA AND LED LIGHT SOURCE
- VIDEO-COUPLING + C-MOUNT CAMERA HEAD
- HD DIGITAL FLAT PANEL COLOR MONITOR
- MEDICAP USB 1000 DIGITAL IMAGE CAPTURE DEVICE
- ELMED MINI ENDOSCOPIC VIDEO CART
- FIBER OPTIC LIGHT CABLE
- STERILE SCOPE HOLDING RACK

SPECIAL PRICE!

WE OFFER SPECIAL PRICING ON OUR ENDOSCOPIC SCOPE SYSTEMS AND SHEATHS WHEN COMBINED WITH OUR VIDEO CART





UROLOGICAL ELECTROSURGERY



MADE IN THE USA

ELECTROSURGERY FOR UROLOGICAL PROCEDURES

FEATURING OUR MOST ECONOMICAL SYSTEM FOR UROLOGICAL OUTPATIENT PROCEDURES.



5781URO ELMED ESU 70 UROLOGICAL SYSTEM

OUTPATIENT UROLOGICAL SURGERY

- REMOVAL OF SMALL TUMORS AND LESIONS WITHIN THE BLADDER, THROUGH THE CYSTOSCOPE AND FLEXIBLE URETHROSCOPE, WITH SPECIAL
- VASECTOMY AND MICROSURGICAL VASECTOMY REVERSAL
- REMOVAL OF SKIN LESIONS AND COAGULATION OF SMALL BLOOD VESSELS
- GENERAL AND MINOR PROCEDURES IN OUTPATIENT UROLOGY

CONSISTING OF:



5195	ESU ELECTROSURGICAL UNIT & FOOTSWITCH
5046-1*	REUSABLE PATIENT PLATE & RETAINING STRAP
5071	REUSABLE PATIENT PLATE & CONNECTING CABLE
5783	REUSABLE FLEXIBLE CYSTO-ELECTRODE
5260	REUSABLE ELECTRODE CONNECTING CABLE
5014-1*	REUSABLE FOOTSWITCH HANDLE & BLADE ELECTRODE
5021	REUSABLE HANDLE CONNECTING CABLE
4755	EQUIPMENT TROLLEY WITH ONE DRAWER
52200-03	STERILIZATION & STORAGE CONTAINER



TO ORDER CALL: (224) 353-6446



UROLOGICAL ELECTROSURGERY



MADE IN THE USA

ELMED HIVOCAUTER ELECTROGURGICAL UNIT

OUR MOST ECONOMICAL AND COMPACT RF ELECTROSURGICAL UNIT TO PERFORM SPRAY COAGULATION DESICCATION, FULGURATION AND CUTTING SURGICAL PROCEDURES, SUCH AS UROLOGICAL VASECTOMY AND VENEREAL WARTS.



5240 ELMED HIVOCAUTER SYSTEM W/
HAND SWITCHING HANDLE

5711 OPTIONAL FOOTSWITCH

FEATURES OF THE UNIT

MODES OF OPERATION:	HAND SWITCH OR FOOTSWITCH
DIMENSION:	9"L x 8"W x 4"H (23CM x 20CM x 10CM)
WEIGHT:	6 LBS. (2.7 KG)

ELMED ESU 170 U ELECTROSURGICAL UNIT

OUR MOST VERSATILE MONOPOLAR/ BIPOLAR GENERATOR FOR TRUE RF-ELECTROSURGERY FOR ALL UROLOGICAL SURGICAL PROCEDURES WITH BOTH FOOT SWITCHING AND HAND SWITCHING ACTIVATION.



ITEM NO.	DESCRIPTION
5795M	ELMED ESU 170 U ELECTROSURGICAL UNIT W/ MONOPOLAR/ BIPOLAR OUTPUT FOOT AND HANDSWITCHING (UNIT INCLUDES FOOTSWITCH)





UROLOGICAL ELECTROSURGERY



MADE IN THE USA

ELMED ESU 400 DIGITAL — THE NEXT STEP IN INNOVATION

SPECIFICALLY DESIGNED FOR ALL YOUR UROLOGICAL PROCEDURES. MONOPOLAR & BIPOLAR —



ITEM No.	DESCRIPTION
5795M	ELMED ESU 400 DIGITAL GEN II
	GENERATION II
	MONOPOLAR CUT + COAGULATION
	BIPOLAR CUT + COAGULATION
	DIGITAL TOUCH SCREEN DISPLAY
	MULTI SCREEN DISPLAY
	INCLUDES MONOPOLAR AND BIPOLAR FOOTSWITCH



TO ORDER CALL: (224) 353-6446



SCALPELS AND HANDLES



MADE IN THE USA

SURGICAL BLADES

STERILE - STAINLESS STEEL

- RAZOR-SHARP CUTTING EDGES FOR SUPERIOR CUTTING AND CLEAN INCISIONS
- INDIVIDUALLY PACKAGED IN FOIL PEEL PACKS
- CONVENIENT SINGLE-USE
- SIZES CLEARLY MARKED ON EACH BLADE
- AVAILABLE IN STAINLESS STEEL
- DISPENSER BOX CONTAINS 100 BLADES
- 11 SIZES

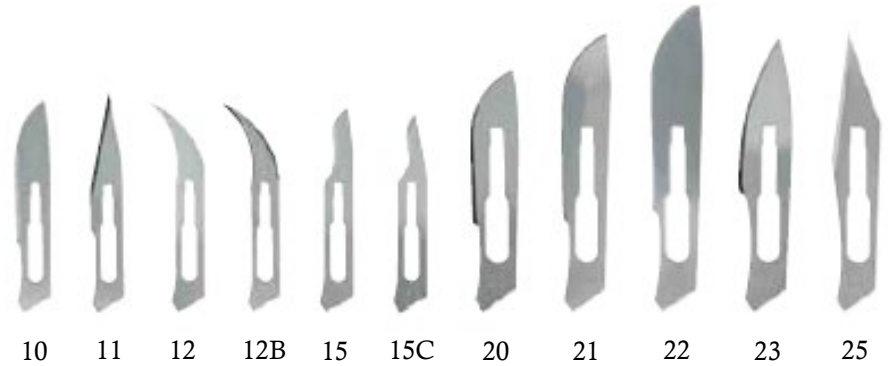

BLADE SIZE	10	11	12	12B	15	15C
ITEM NO.	10-15-10	10-155-11	10-15-12	10-15-14	10-15-15	10-15-16
BLADE SIZE	20	21	22	23	25	3K MINIATURE BLADE (NOT PICTURED)
ITEM NO.	10-15-20	10-15-21	10-15-22	10-15-23	10-15-25	10-15-30

SCALPEL HANDLES REUSABLE - STAINLESS STEEL



	ITEM NO.	DESCRIPTION	LENGTH	FITS BLADES	
				10-15C	20-25
A	10-10-03	NO. 3 KNIFE HANDLE	5"	X	-
A-1	10-10-03M	NO. 3 KNIFE HANDLE, GRADUATED	5"	X	-
B	10-10-04	NO. 4 KNIFE HANDLE	5-3/8"	-	X
B-1	10-10-04M	NO. 4 KNIFE HANDLE, GRADUATED	5-3/8"	-	X
C	10-10-07	NO. 7 KNIFE HANDLE	6-1/2"	X	-
D	10-10-17	NO. 7 KNIFE HANDLE	4-1/2"	X	-
E	10-10-13	NO. 3L KNIFE HANDLE	8-1/2"	X	-
F	10-10-13A	NO. 3L KNIFE HANDLE, ANGLED	8-1/2"	X	-
G	10-10-14	NO. 4L KNIFE HANDLE	8-1/2"	-	X
H	10-10-14A	NO. 4L KNIFE HANDLE, ANGLED	8-1/2"	-	X
I	10-10-15	NO. 5 PLASTIC HANDLE, GREEN	5"	X	-
J	10-10-16	NO. 6 PLASTIC HANDLE, RED	5-1/4"	-	X
K	10-10-18	SELF-LOCKING CHUCK HANDLE	3-3/4"	3K BLADES	
K-1	10-10-19	SELF-LOCKING CHUCK HANDLE	5-1/2"	3K BLADES	
K-2	10-10-20	SELF-LOCKING CHUCK HANDLE	9"	3K BLADES	





ADVANCED URO-MINIMAL INVASIVE



MADE IN THE USA

ELMED BULLDOG CLAMP FOR LAPAROSCOPIC APPLICATION

- FEATURING BULLDOG DIPS THAT ARE APPLIED LAPAROSCOPICALLY FOR INTRAOPERATIVE OCCLUSION AND ARE THEREFORE CALLED TEMPORARY CLIPS.
- PROCEDURES PROVIDE ARTERIAL AND VENOUS CLAMPING OF THE RENAL HILUM FOR A CLEAN OPERATIVE FIELD.
- THESE PRECISION MADE INSTRUMENTS ARE AVAILABLE IN A VARIETY OF SIZES AND HAVE BEEN MOST COMMONLY USED FOR PARTIAL NEPHRECTOMY AND BOWEL RESECTION.



ITEM NO.	DESCRIPTION
52132-01	10MM 32CM ELMED BULLDOG CLIP APPLIER / REMOVER. STAINLESS STEEL, LOCKING HANDLE, ROTATABLE W/ FLUSH PORT. AUTOCLAVABLE MEDICAL GRADE STAINLESS STEEL

ELMED BULLDOG CLAMP — NON STERILE AUTOCLAVABLE MEDICAL GRADE STAINLESS STEEL



FOR COMPLETE ENDO-MINIMAL INSTRUMENT LISTING SEE OUR: LAPAROSCOPIC CATALOG

ITEM NO.	DESCRIPTION	
52100-45	STRAIGHT BOWEL	— 45 MM JAW
52100-60	STRAIGHT BOWEL	— 60 MM JAW
52200-17	STRAIGHT VASCULAR	— 17 MM JAW
52200-25	CURVED VASCULAR	— 25 MM JAW
52300-17*	CURVED VASCULAR	— 17 MM JAW
52300-25*	CURVED BOWEL	— 25 MM JAW
52400-45*	CURVED BOWEL	— 45 MM JAW
52400-60*	CURVED BOWEL	— 60 MM JAW
52500-60	SATINSKY TROCAR CLAMP	— 60 MM JAW
52600-60	SATINSKY TROCAR CLAMP	— 60 MM JAW

* REQUIRES 12MM TROCAR CANNULA



TO ORDER CALL: (224) 353-6446



SERVICE AND REPAIR



MADE IN THE USA

IN NEED OF INSTRUMENT REPAIRS? SEND THEM TO THE *ER!*

ELMED REPAIR

60 YEARS OF EXPERIENCE AND KNOWLEDGE IN DESIGNING, ENGINEERING, MANUFACTURING AND REPAIRING FOR THE MEDICAL COMMUNITY HAS GIVEN ELMED, INC. ONE OF THE BEST REPUTATIONS IN THE INDUSTRY. WE REPAIR WHAT OTHERS ARE UNABLE OR UNWILLING TO DO AND WE REPAIR ALL COMPETITIVE BRANDS. OUR WORK IS PERFORMED BY SKILLED TECHNICIANS, ALL OF WHICH HAVE BEEN WITH ELMED FOR THE PAST 10-30 YEARS.

COMPLETE IN-HOUSE MACHINE SHOP, POWDER COATING, LASER WELDING, & MARKING FINISHING, ELECTRONICS AND OPTICAL DEPARTMENTS

AREAS OF SPECIALTY

- LAPAROSCOPIC AND ENDOSCOPIC INSTRUMENTS
- ELECTROSURGICAL UNITS AND ACCESSORIES
- FIBER OPTIC LIGHT CABLES AND RETRACTORS
- RIGID ENDOSCOPES & FLEXIBLE SINUSCOPES
- STAINLESS STEEL HAND INSTRUMENTS
- LIGHT SOURCES AND HEADLIGHTS
- DEBRIDER UNITS, HAND PIECES AND BLADES
- SELF RETAINING RETRACTOR SYSTEMS

HOW TO PACKAGE AND SHIP INSTRUMENTS

- **IMPORTANT:** ELMED CANNOT ACCEPT INSTRUMENTS THAT HAVE NOT BEEN PROPERLY CLEANED, DISINFECTED OR STERILIZED.
- INCLUDE CUSTOMER NAME AND ALL CONTACT INFORMATION (NAME, ADDRESS, PHONE NO., FAX NO., EMAIL ADDRESS, ETC.)
- INCLUDE CUSTOMER P.O. (PURCHASE ORDER), IF USED
- INCLUDE REASON FOR RETURN - BRIEF DESCRIPTION OF REPAIR PROBLEM IF AVAILABLE
- WRAP INSTRUMENT FOR PROTECTION DURING TRANSPORT

PLEASE FILL OUT, DETACH, AND INCLUDE THE FORM BELOW WITH YOUR REPAIR:

FROM:	
FACILITY:	CONTACT PERSON:
ADDRESS:	
CITY, STATE, ZIP	
EMAIL:	PHONE NO.
PO. NO.	QTY.

INSTRUMENT DESCRIPTION:

(NOTE: PLEASE INCLUDE MODEL NO. AND SERIAL NO. IN INSTRUMENT DESCRIPTION FOR SCOPES)

FAST SERVICE: INCOMING REPAIRS COMING IN BY NEXT DAY AIR WILL BE COMPLETED WITHIN 24 HRS (WHEN PARTS ARE AVAILABLE)

SHIP TO: **ELMED** 35 N BRANDON DR., GLENDALE HEIGHTS, IL 60139